



Evolution Wireless Digital

PDF export of the original HTML instructions



Contents

1. Preface.....	10
2. Product information.....	11
Products of the EW-D series.....	11
EW-D EM rack receiver.....	12
EW-D SKM-S handheld transmitter.....	13
EW-D SK bodypack transmitter.....	14
Sets available for the EW-D series.....	16
EW-D ME2 SET Lavalier Set.....	16
EW-D ME3 SET Headmic Set.....	18
EW-D ME4 SET Lavalier Set.....	20
EW-D CI1 SET Instrument Set.....	21
EW-D SK BASE SET Base Set.....	22
EW-D 835-S SET Handheld Set.....	24
EW-D SKM-S BASE SET Base Set.....	26
EW-D ME2/835-S SET Combo Set.....	28
Products of the EW-DX series.....	30
EW-DX EM 2 rack receiver.....	30
EW-DX EM 2 Dante rack receiver.....	32
EW-DX EM 4 Dante rack receiver.....	33
EW-DX SKM EW-DX SKM-S handheld transmitter.....	34
EW-DX SK EW-DX SK 3-PIN bodypack transmitter.....	36
Table stand EW-DX TS 3-pin EW-DX TS 5-pin.....	38
Sets available for the EW-DX series.....	40
EW-DX 835-S SET Handheld Set.....	40
EW-DX MKE 2 SET Lavalier Set.....	42
EW-DX MKE 2-835-S SET Combo Set.....	44
EW-DX SK-SKM-S BASE SET Base Set.....	46
Products of the EW-DP series.....	48
EW-DP EK portable receiver.....	49
EW-DP SKP plug-on transmitter.....	50
Sets available for the EW-DP series.....	51
EW-DP ME-2 Lavalier Set.....	51
EW-DP ME-4 Lavalier Set.....	53
EW-DP 835 Handheld Set.....	55
EW-DP ENG Lavalier Set.....	57



Smart Assist app.....	59
Accessories.....	60
BA 70 rechargeable battery and L 70 USB charger.....	60
CHG 70N-C network-enabled charger.....	62
EW-D ASA antenna splitter.....	64
EW-D AB antenna splitter.....	65
Antennas.....	66
Accessories for rack mounting.....	70
Mounting accessories for EW-DP EK.....	71
Cables for EW-DP EK.....	72
Color Coding Sets.....	73
Frequency ranges.....	74
3. Instruction manual.....	77
EW-D EM rack receiver.....	78
Product overview.....	78
Connecting/disconnecting the receiver to/from the power supply system.....	81
Connecting antennas.....	83
Outputting audio signals.....	85
Installing receivers in a rack.....	86
Switching the receiver on and off.....	89
Lock-off function.....	90
Meaning of the LEDs.....	91
Displays on the receiver's display panel.....	93
Buttons for navigating the menu.....	95
Opening the menu and navigating the menu items.....	96
Using EW-D Color Coding Sets to label transmission paths.....	104
EW-D SKM-S handheld transmitter.....	105
Product overview.....	105
Inserting and removing the batteries/rechargeable batteries.....	107
Replacing the microphone module.....	109
Using EW-D Color Coding Sets to label transmission paths.....	111
Switching the handheld transmitter on and off.....	112
Checking the battery status of the transmitter (Check function).....	113
Identifying the paired receiver (Identify function).....	114
Meaning of the LEDs.....	115
Establishing a connection to the receiver.....	118
Muting the handheld transmitter.....	119



EW-D SK bodypack transmitter.....	120
Product overview.....	120
Inserting and removing the batteries/rechargeable batteries.....	122
Connecting a microphone to the bodypack transmitter.....	124
Connecting an instrument or line source to the bodypack transmitter.....	126
Using EW-D Color Coding Sets to label transmission paths.....	127
Changing the belt clip.....	128
Switching the bodypack transmitter on and off.....	129
Checking the battery status of the transmitter (Check function).....	130
Identifying the paired receiver (Identify function).....	131
Meaning of the LEDs.....	132
Establishing a connection to the receiver.....	135
Muting the bodypack transmitter.....	136
EW-DX EM 2 rack receiver.....	137
Product overview.....	138
Connecting/disconnecting the receiver to/from the power supply system.....	141
Connecting receivers in a network.....	144
Connecting antennas.....	145
Outputting audio signals.....	147
Installing receivers in a rack.....	149
Switching the receiver on and off.....	152
Lock-off function.....	153
Using the headphone output.....	154
Meaning of the LEDs.....	155
Displays on the receiver's display panel.....	157
Buttons for navigating the menu.....	165
Opening the menu and navigating the menu items.....	166
Menu structure.....	167
Setting options in the menu.....	168
System menu item.....	194
Updating the firmware of the receiver.....	206
EW-DX EM 2 Dante rack receiver.....	207
Product overview.....	208
Connecting/disconnecting the receiver to/from the power supply system.....	211
Connecting receivers in a network.....	214
Connecting receivers in a Dante® network.....	215
Connecting antennas.....	221



Outputting audio signals.....	223
Installing receivers in a rack.....	225
Switching the receiver on and off.....	228
Lock-off function.....	229
Using the headphone output.....	230
Meaning of the LEDs.....	231
Displays on the receiver's display panel.....	233
Buttons for navigating the menu.....	241
Opening the menu and navigating the menu items.....	242
Menu structure.....	243
Setting options in the menu.....	244
System menu item.....	270
Updating the firmware of the receiver.....	282
EW-DX EM 4 Dante rack receiver.....	283
Product overview.....	284
Connecting/disconnecting the receiver to/from the power supply system.....	288
Connecting receivers in a network.....	289
Connecting receivers in a Dante® network.....	290
Connecting antennas.....	295
Outputting audio signals.....	298
Installing receivers in a rack.....	300
Switching the receiver on and off.....	302
Lock-off function.....	303
Using the headphone output.....	304
Meaning of the LEDs.....	305
Displays on the receiver's display panel.....	307
Buttons for navigating the menu.....	314
Opening the menu and navigating the menu items.....	315
Menu structure.....	316
Setting options in the menu.....	317
System menu item.....	343
Updating the firmware of the receiver.....	355
EW-DX SKM EW-DX SKM-S handheld transmitter.....	356
Product overview.....	356
Inserting and removing the batteries/rechargeable batteries.....	358
Replacing the microphone module.....	360
Switching the handheld transmitter on and off.....	362



Checking the battery status of the transmitter (Check function).....	363
Identifying the paired receiver (Identify function).....	364
Meaning of the LEDs.....	365
Establishing a connection to the receiver.....	368
Information on the handheld transmitter's display.....	369
Buttons for navigating the menu.....	371
Opening the menu and navigating the menu items.....	372
Lock-off function.....	384
Configuring mute mode and muting the handheld transmitter (EW-DX SKM-S only).....	385
Updating the firmware of the transmitter.....	387
EW-DX SK EW-DX SK 3-PIN bodypack transmitter.....	388
Product overview.....	389
Inserting and removing the batteries/rechargeable batteries.....	391
Connecting a microphone to the bodypack transmitter.....	393
Connecting an instrument or line source to the bodypack transmitter.....	397
Changing the belt clip.....	399
Switching the bodypack transmitter on and off.....	400
Checking the battery status of the transmitter (Check function).....	401
Identifying the paired receiver (Identify function).....	402
Meaning of the LEDs.....	403
Establishing a connection to the receiver.....	406
Information on the bodypack transmitter's display.....	407
Buttons for navigating the menu.....	409
Opening the menu and navigating the menu items.....	410
Lock-off function.....	423
Configuring mute mode and muting the bodypack transmitter.....	424
Updating the firmware of the transmitter.....	425
Table stand EW-DX TS 3-pin EW-DX TS 5-pin.....	426
Product overview.....	426
Inserting and removing the BA 40 rechargeable battery.....	428
Charging the table stand.....	429
Meaning of the LEDs.....	431
Connecting a gooseneck microphone.....	433
Switching the table stand on/off.....	434
Establishing a connection to the receiver.....	435
Muting the table stand.....	436



EW-DP EK portable receiver.....	437
Product overview.....	438
Power supply.....	440
Outputting audio signals.....	442
Mounting the receiver / mounting options.....	443
Switching the receiver on and off.....	452
Meaning of the LEDs.....	453
Displays on the receiver's display panel.....	455
Buttons for navigating the menu.....	457
Opening the menu and navigating the menu items.....	458
EW-DP SKP plug-on transmitter.....	468
Product overview.....	468
Power supply.....	471
Using a microSD card.....	473
Attaching an XLR microphone.....	475
Connecting a lavalier microphone.....	476
Switching the plug-on transmitter on and off.....	477
Starting/stopping recording.....	478
MUTE mode.....	479
Meaning of the LEDs.....	480
Establishing a radio link Synchronizing the receiver and transmitter.....	484
Connecting to the EW-D EM receiver / synchronizing the EW-D EM.....	485
Connecting to the EW-DX EM receivers / synchronizing the EW-DX EM.....	487
Connecting to the EW-DP EK receiver / synchronizing the EW-DP EK.....	489
L 70 USB charger.....	491
Connecting/disconnecting the charger to/from the power supply system.....	491
Charging the rechargeable battery.....	492
CHG 70N-C charger.....	494
Product overview.....	494
Connecting/disconnecting the charger to/from the power supply system.....	496
Connecting a charger in a network.....	498
Cascading chargers.....	500
Charging the rechargeable battery.....	502
Power saving mode.....	504
EW-D ASA antenna splitter.....	505
Product overview.....	505
Connecting/disconnecting the EW-D ASA to/from the power supply system.....	507



Connecting receivers to the EW-D ASA.....	508
Connecting antennas.....	509
Information on antenna amplifiers and cable lengths.....	510
Configuring multi-channel systems.....	511
Installing the EW-D ASA in a rack.....	513
Switching the EW-D ASA on and off.....	514
AWM active directional antenna.....	515
Product overview.....	515
Antenna setup.....	518
Connecting the cable to the antenna.....	519
Recommended cable lengths.....	521
Installing and mounting the antenna.....	522
Setting the gain.....	529
GAIN LED.....	530
Cleaning and maintenance.....	531
4. Frequently asked questions.....	533
Radio and frequencies.....	533
Audio.....	536
Usability.....	538
Accessories.....	542
Smart Assist app.....	544
5. Specifications.....	546
System.....	546
EW-D EM rack receiver.....	548
EW-DX EM 2 rack receiver.....	549
EW-DX EM 2 Dante rack receiver.....	550
EW-DX EM 4 Dante rack receiver.....	551
EW-D SKM-S handheld transmitter.....	552
EW-DX SKM EW-DX SKM-S handheld transmitter.....	553
EW-D SK bodypack transmitter.....	554
EW-DX SK EW-DX SK 3-PIN bodypack transmitter.....	555
Table stand EW-DX TS 3-pin EW-DX TS 5-pin.....	556
EW-DP EK portable receiver.....	557
EW-DP SKP plug-on transmitter receiver.....	558
EW-D ASA antenna splitter.....	559
EW-D AB antenna booster.....	562
AWM active directional antenna.....	563



ADP UHF passive directional antenna (470 – 1075 MHz).....	570
BA 70 rechargeable battery.....	572
L 70 USB charger.....	573
CHG 70N-C charger.....	574
6. Contact.....	576



1. Preface

PDF export of the original HTML instructions

This PDF document is an automated export of an interactive set of HTML instructions. It may be the case that not all contents and interactive elements are contained in the PDF as they cannot be presented in this format. Furthermore, automatically generated page breaks may cause coherent contents to be moved slightly. We can therefore only guarantee the completeness of the information in the HTML instructions, and recommend that you use these. You can find these in the download section of the website under www.sennheiser.com/download.



2. Product information

All information about the product and available accessories at a glance.

- [Products of the EW-D series](#)
- [Sets available for the EW-D series](#)
- [Products of the EW-DX series](#)
- [Sets available for the EW-DX series](#)
- [Products of the EW-DP series](#)
- [Sets available for the EW-DP series](#)
- [Smart Assist app](#)
- [Accessories](#)
- [Frequency ranges](#)

Products of the EW-D series



For information about the available **accessories**, see [Accessories](#).

For information about the available **sets**, see [Sets available for the EW-D series](#).

For information about the **frequency ranges**, see [Frequency ranges](#).

You can find technical **specifications** for the series and the individual products under [Specifications](#).



You can find information about **starting up** and **operating** the products under [Instruction manual](#).

EW-D EM rack receiver



The **EW-D EM** rack receiver is available in the following versions:

EW-D EM (Q1-6) | 470.2 – 526 MHz | Art. no. 508800

EW-D EM (R1-6) | 520 – 576 MHz | Art. no. 508801

EW-D EM (R4-9) | 552 – 607.8 MHz | Art. no. 508802

EW-D EM (S1-7) | 606.2 – 662 MHz | Art. no. 508803

EW-D EM (S4-7) | 630 – 662 MHz | Art. no. 508804

EW-D EM (S7-10) | 662 – 693.8 MHz | Art. no. 508805

EW-D EM (U1/5) | 823.2 – 831.8 MHz & 863.2 – 864.8 MHz | Art. no. 508806

EW-D EM (V3-4) | 925.2 – 937.3 MHz | Art. no. 508808

EW-D EM (Y1-3) | 1785.2 – 1799.8 MHz | Art. no. 508809

i You can find more detailed information about the EW-D EM in the following sections:

- **Startup and operation:** [EW-D EM rack receiver](#)
- **Specifications:** [EW-D EM rack receiver](#)



EW-D SKM-S handheld transmitter



The **EW-D SKM-S** handheld transmitter is available in the following versions:

EW-D SKM-S (Q1-6) | 470.2 – 526 MHz | Art. no. 508790

EW-D SKM-S (R1-6) | 520 – 576 MHz | Art. no. 508791

EW-D SKM-S (R4-9) | 552 – 607.8 MHz | Art. no. 508792

EW-D SKM-S (S1-7) | 606.2 – 662 MHz | Art. no. 508793

EW-D SKM-S (S4-7) | 630 – 662 MHz | Art. no. 508794

EW-D SKM-S (S7-10) | 662 – 693.8 MHz | Art. no. 508795

EW-D SKM-S (U1/5) | 823.2 – 831.8 MHz & 863.2 – 864.8 MHz | Art. no. 508796

EW-D SKM-S (V3-4) | 925.2 – 937.3 MHz | Art. no. 508798

EW-D SKM-S (Y1-3) | 1785.2 – 1799.8 MHz | Art. no. 508799

i You can find more detailed information about the EW-D SKM-S in the following sections:

- **Startup and operation:** [EW-D SKM-S handheld transmitter](#)
- **Specifications:** [EW-D SKM-S handheld transmitter](#)
- **Compatible microphone modules:** [Replacing the microphone module](#)



EW-D SK bodypack transmitter



The **EW-D SK** bodypack transmitter is available in the following versions:

EW-D SK (Q1-6) | 470.2 – 526 MHz | Art. no. 508780

EW-D SK (R1-6) | 520 – 576 MHz | Art. no. 508781

EW-D SK (R4-9) | 552 – 607.8 MHz | Art. no. 508782

EW-D SK (S1-7) | 606.2 – 662 MHz | Art. no. 508783

EW-D SK (S4-7) | 630 – 662 MHz | Art. no. 508784

EW-D SK (S7-10) | 662 – 693.8 MHz | Art. no. 508785

EW-D SK (U1/5) | 823.2 – 831.8 MHz & 863.2 – 864.8 MHz | Art. no. 508786

EW-D SK (V3-4) | 925.2 – 937.3 MHz | Art. no. 508788

EW-D SK (Y1-3) | 1785.2 – 1799.8 MHz | Art. no. 508789



i You can find more detailed information about the EW-D SK in the following sections:

- **Startup and operation:** [EW-D SK bodypack transmitter](#)
- **Specifications:** [EW-D SK bodypack transmitter](#)
- **Compatible microphones:** [Connecting a microphone to the bodypack transmitter](#)



Sets available for the EW-D series

Related information

- [EW-D ME2 SET | Lavalier Set](#)
- [EW-D ME3 SET | Headmic Set](#)
- [EW-D ME4 SET | Lavalier Set](#)
- [EW-D CI1 SET | Instrument Set](#)
- [EW-D SK BASE SET | Base Set](#)
- [EW-D 835-S SET | Handheld Set](#)
- [EW-D SKM-S BASE SET | Base Set](#)
- [EW-D ME2/835-S SET | Combo Set](#)

EW-D ME2 SET | Lavalier Set



The set consists of the following components:

- **EW-D EM** rack receiver
- **EW-D SK** bodypack transmitter
- **ME 2** lavalier microphone

The set is available in the following versions:

EW-D ME2 SET (Q1-6) | 470.2 – 526 MHz | Art. no. 508700

EW-D ME2 SET (R1-6) | 520 – 576 MHz | Art. no. 508701

EW-D ME2 SET (R4-9) | 552 – 607.8 MHz | Art. no. 508702

EW-D ME2 SET (S1-7) | 606.2 – 662 MHz | Art. no. 508703



EW-D ME2 SET (S4-7) | 630 – 662 MHz | Art. no. 508704

EW-D ME2 SET (S7-10) | 662 – 693.8 MHz | Art. no. 508705

EW-D ME2 SET (U1/5) | 823.2 – 831.8 MHz & 863.2 – 864.8 MHz | Art. no. 508706

EW-D ME2 SET (V3-4) | 925.2 – 937.3 MHz | Art. no. 508708

EW-D ME2 SET (Y1-3) | 1785.2 – 1799.8 MHz | Art. no. 508709

i You can find more detailed information about the set in the following sections:

- **Startup and operation:** [Instruction manual](#)
- **Specifications:** [Specifications](#)



EW-D ME3 SET | Headmic Set



The set consists of the following components:

- **EW-D EM** rack receiver
- **EW-D SK** bodypack transmitter
- **ME 3** lavalier microphone

The set is available in the following versions:

EW-D ME3 SET (Q1-6) | 470.2 – 526 MHz | Art. no. 508710

EW-D ME3 SET (R1-6) | 520 – 576 MHz | Art. no. 508711

EW-D ME3 SET (R4-9) | 552 – 607.8 MHz | Art. no. 508712

EW-D ME3 SET (S1-7) | 606.2 – 662 MHz | Art. no. 508713

EW-D ME3 SET (S4-7) | 630 – 662 MHz | Art. no. 508714

EW-D ME3 SET (S7-10) | 662 – 693.8 MHz | Art. no. 508715

EW-D ME3 SET (U1/5) | 823.2 – 831.8 MHz & 863.2 – 864.8 MHz | Art. no. 508716

EW-D ME3 SET (V3-4) | 925.2 – 937.3 MHz | Art. no. 508718

EW-D ME3 SET (Y1-3) | 1785.2 – 1799.8 MHz | Art. no. 508719



i You can find more detailed information about the set in the following sections:

- **Startup and operation:** [Instruction manual](#)
- **Specifications:** [Specifications](#)



EW-D ME4 SET | Lavalier Set



The set consists of the following components:

- **EW-D EM** rack receiver
- **EW-D SK** bodypack transmitter
- **ME 4** lavalier microphone

The set is available in the following versions:

EW-D ME4 SET (Q1-6) | 470.2 – 526 MHz | Art. no. 508720

EW-D ME4 SET (R1-6) | 520 – 576 MHz | Art. no. 508721

EW-D ME4 SET (R4-9) | 552 – 607.8 MHz | Art. no. 508722

EW-D ME4 SET (S1-7) | 606.2 – 662 MHz | Art. no. 508723

EW-D ME4 SET (S4-7) | 630 – 662 MHz | Art. no. 508724

EW-D ME4 SET (S7-10) | 662 – 693.8 MHz | Art. no. 508725

EW-D ME4 SET (U1/5) | 823.2 – 831.8 MHz & 863.2 – 864.8 MHz | Art. no. 508726

EW-D ME4 SET (V3-4) | 925.2 – 937.3 MHz | Art. no. 508728

EW-D ME4 SET (Y1-3) | 1785.2 – 1799.8 MHz | Art. no. 508729

i You can find more detailed information about the set in the following sections:

- **Startup and operation:** [Instruction manual](#)
- **Specifications:** [Specifications](#)



EW-D CI1 SET | Instrument Set



The set consists of the following components:

- **EW-D EM** rack receiver
- **EW-D SK** bodypack transmitter
- **CI 1** lavalier microphone

The set is available in the following versions:

EW-D CI1 SET (Q1-6) | 470.2 – 526 MHz | Art. no. 508730

EW-D CI1 SET (R1-6) | 520 – 576 MHz | Art. no. 508731

EW-D CI1 SET (R4-9) | 552 – 607.8 MHz | Art. no. 508732

EW-D CI1 SET (S1-7) | 606.2 – 662 MHz | Art. no. 508733

EW-D CI1 SET (S4-7) | 630 – 662 MHz | Art. no. 508734

EW-D CI1 SET (S7-10) | 662 – 693.8 MHz | Art. no. 508735

EW-D CI1 SET (U1/5) | 823.2 – 831.8 MHz & 863.2 – 864.8 MHz | Art. no. 508736

EW-D CI1 SET (V3-4) | 925.2 – 937.3 MHz | Art. no. 508738

EW-D CI1 SET (Y1-3) | 1785.2 – 1799.8 MHz | Art. no. 508739

i You can find more detailed information about the set in the following sections:

- **Startup and operation:** [Instruction manual](#)
- **Specifications:** [Specifications](#)



EW-D SK BASE SET | Base Set



The set consists of the following components:

- **EW-D EM** rack receiver
- **EW-D SK** bodypack transmitter

The set is available in the following versions:

EW-D SK BASE SET (Q1-6) | 470.2 – 526 MHz | Art. no. 508740

EW-D SK BASE SET (R1-6) | 520 – 576 MHz | Art. no. 508741

EW-D SK BASE SET (R4-9) | 552 – 607.8 MHz | Art. no. 508742

EW-D SK BASE SET (S1-7) | 606.2 – 662 MHz | Art. no. 508743

EW-D SK BASE SET (S4-7) | 630 – 662 MHz | Art. no. 508744

EW-D SK BASE SET (S7-10) | 662 – 693.8 MHz | Art. no. 508745

EW-D SK BASE SET (U1/5) | 823.2 – 831.8 MHz & 863.2 – 864.8 MHz | Art. no. 508746

EW-D SK BASE SET (V3-4) | 925.2 – 937.3 MHz | Art. no. 508748

EW-D SK BASE SET (Y1-3) | 1785.2 – 1799.8 MHz | Art. no. 508749



i You can find more detailed information about the set in the following sections:

- **Startup and operation:** [Instruction manual](#)
- **Specifications:** [Specifications](#)



EW-D 835-S SET | Handheld Set



The set consists of the following components:

- **EW-D EM** rack receiver
- **EW-D SKM-S** handheld transmitter
- **MMD 835** microphone module

The set is available in the following versions:

EW-D 835-S SET (Q1-6) | 470.2 – 526 MHz | Art. no. 508750

EW-D 835-S SET (R1-6) | 520 – 576 MHz | Art. no. 508751

EW-D 835-S SET (R4-9) | 552 – 607.8 MHz | Art. no. 508752

EW-D 835-S SET (S1-7) | 606.2 – 662 MHz | Art. no. 508753

EW-D 835-S SET (S4-7) | 630 – 662 MHz | Art. no. 508754

EW-D 835-S SET (S7-10) | 662 – 693.8 MHz | Art. no. 508755

EW-D 835-S SET (U1/5) | 823.2 – 831.8 MHz & 863.2 – 864.8 MHz | Art. no. 508756

EW-D 835-S SET (V3-4) | 925.2 – 937.3 MHz | Art. no. 508758

EW-D 835-S SET (Y1-3) | 1785.2 – 1799.8 MHz | Art. no. 508759



i You can find more detailed information about the set in the following sections:

- **Startup and operation:** [Instruction manual](#)
- **Specifications:** [Specifications](#)



EW-D SKM-S BASE SET | Base Set



The set consists of the following components:

- **EW-D EM** rack receiver
- **EW-D SKM-S** handheld transmitter

The set is available in the following versions:

EW-D SKM-S BASE SET (Q1-6) | 470.2 – 526 MHz | Art. no. 508740

EW-D SKM-S BASE SET (R1-6) | 520 – 576 MHz | Art. no. 508741

EW-D SKM-S BASE SET (R4-9) | 552 – 607.8 MHz | Art. no. 508742

EW-D SKM-S BASE SET (S1-7) | 606.2 – 662 MHz | Art. no. 508743

EW-D SKM-S BASE SET (S4-7) | 630 – 662 MHz | Art. no. 508744

EW-D SKM-S BASE SET (S7-10) | 662 – 693.8 MHz | Art. no. 508745

EW-D SKM-S BASE SET (U1/5) | 823.2 – 831.8 MHz & 863.2 – 864.8 MHz | Art. no. 508746

EW-D SKM-S BASE SET (V3-4) | 925.2 – 937.3 MHz | Art. no. 508748

EW-D SKM-S BASE SET (Y1-3) | 1785.2 – 1799.8 MHz | Art. no. 508749



i You can find more detailed information about the set in the following sections:

- **Startup and operation:** [Instruction manual](#)
- **Specifications:** [Specifications](#)



EW-D ME2/835-S SET | Combo Set



The set consists of the following components:

- **EW-D EM** rack receiver
- **EW-D SK** bodypack transmitter
- **EW-D SKM-S** handheld transmitter
- **ME 2** lavalier microphone
- **MMD 835** microphone module

The set is available in the following versions:

EW-D ME2/835-S SET (Q1-6) | 470.2 – 526 MHz | Art. no. 508770

EW-D ME2/835-S SET (R1-6) | 520 – 576 MHz | Art. no. 508771

EW-D ME2/835-S SET (R4-9) | 552 – 607.8 MHz | Art. no. 508772

EW-D ME2/835-S SET (S1-7) | 606.2 – 662 MHz | Art. no. 508773

EW-D ME2/835-S SET (S4-7) | 630 – 662 MHz | Art. no. 508774

EW-D ME2/835-S SET (S7-10) | 662 – 693.8 MHz | Art. no. 508775

EW-D ME2/835-S SET (U1/5) | 823.2 – 831.8 MHz & 863.2 – 864.8 MHz | Art. no. 508776

EW-D ME2/835-S SET (V3-4) | 925.2 – 937.3 MHz | Art. no. 508778

EW-D ME2/835-S SET (Y1-3) | 1785.2 – 1799.8 MHz | Art. no. 508779



i You can find more detailed information about the set in the following sections:

- **Startup and operation:** [Instruction manual](#)
- **Specifications:** [Specifications](#)



Products of the EW-DX series



For information about the available **accessories**, see [Accessories](#).

For information about the available **sets**, see [Sets available for the EW-DX series](#).

For information about the **frequency ranges**, see [Frequency ranges](#).

You can find technical **specifications** for the series and the individual products under [Specifications](#).

You can find information about **starting up** and **operating** the products under [Instruction manual](#).

EW-DX EM 2 rack receiver



The **EW-DX EM 2** rack receiver is available in the following versions:

EW-DX EM 2 (Q1-9) | 470.2 – 550 MHz | Art. no. 509342

EW-DX EM 2 (R1-9) | 520 – 607.8 MHz | Art. no. 509343

EW-DX EM 2 (S1-10) | 606.2 – 693.8 MHz | Art. no. 509344



EW-DX EM 2 (S2-10) | 614.2 – 693.8 MHz | Art. no. 509347

EW-DX EM 2 (S4-10) | 630 – 693.8 MHz | Art. no. 509348

EW-DX EM 2 (U1/5) | 823.2 – 831.8 MHz & 863.2 – 864.8 MHz | Art. no. 509349

EW-DX EM 2 (V3-4) | 925.2 – 937.3 MHz | Art. no. 509351

EW-DX EM 2 (V5-7) | 941.7 – 951.8 MHz & 953.05 – 956.05 MHz & 956.65 – 959.65 MHz |
Art. no. 509352

EW-DX EM 2 (Y1-3) | 1785.2 – 1799.8 MHz | Art. no. 509355

i You can find more detailed information about the EW-DX EM 2 in the following sections:

- **Startup and operation:** [EW-DX EM 2 rack receiver](#)
- **Specifications:** [EW-DX EM 2 rack receiver](#)



EW-DX EM 2 Dante rack receiver



The **EW-DX EM 2 Dante** rack receiver is available in the following versions:

EW-DX EM 2 Dante (Q1-9) | 470.2 – 550 MHz | Art. no. 509356

EW DX EM 2 Dante (R1-9) | 520 – 607.8 MHz | Art. no. 509357

EW DX EM 2 Dante (S1-10) | 606.2 – 693.8 MHz | Art. no. 509358

EW DX EM 2 Dante (S2-10) | 614.2 – 693.8 MHz | Art. no. 509361

EW DX EM 2 Dante (S4-10) | 630 – 693.8 MHz | Art. no. 509362

EW-DX EM 2 Dante (U1/5) | 823.2 – 831.8 MHz & 863.2 – 864.8 MHz | Art. no. 509363

EW DX EM 2 Dante (V3-4) | 925.2 – 937.3 MHz | Art. no. 509365

EW-DX EM 2 Dante (V5-7) | 941.7 – 951.8 MHz & 953.05 – 956.05 MHz & 956.65 – 959.65 MHz | Art. no. 509366

EW DX EM 2 Dante (Y1-3) | 1785.2 – 1799.8 MHz | Art. no. 509369

i You can find more detailed information about the EW-DX EM 2 Dante in the following sections:

- **Startup and operation:** [EW-DX EM 2 Dante rack receiver](#)
- **Specifications:** [EW-DX EM 2 Dante rack receiver](#)



EW-DX EM 4 Dante rack receiver



The **EW-DX EM 4 Dante** rack receiver is available in the following versions:

EW-DX EM 4 Dante (Q1-9) | 470.2 – 550 MHz | Art. no. 509370

EW DX EM 4 Dante (R1-9) | 520 – 607.8 MHz | Art. no. 509371

EW DX EM 4 Dante (S1-10) | 606.2 – 693.8 MHz | Art. no. 509372

EW DX EM 4 Dante (S2-10) | 614.2 – 693.8 MHz | Art. no. 509375

EW DX EM 4 Dante (S4-10) | 630 – 693.8 MHz | Art. no. 509376

EW-DX EM 4 Dante (U1/5) | 823.2 – 831.8 MHz & 863.2 – 864.8 MHz | Art. no. 509377

EW DX EM 4 Dante (V3-4) | 925.2 – 937.3 MHz | Art. no. 509379

EW-DX EM 4 Dante (V5-7) | 941.7 – 951.8 MHz & 953.05 – 956.05 MHz & 956.65 – 959.65 MHz | Art. no. 509380

EW DX EM 4 Dante (Y1-3) | 1785.2 – 1799.8 MHz | Art. no. 509383

i You can find more detailed information about the EW-DX EM 4 Dante in the following sections:

- **Startup and operation:** [EW-DX EM 4 Dante rack receiver](#)
- **Specifications:** [EW-DX EM 4 Dante rack receiver](#)



EW-DX SKM | EW-DX SKM-S handheld transmitter



Handheld transmitter without mute switch

The **EW-DX SKM** handheld transmitter without mute switch is available in the following versions:

EW-DX SKM (Q1-9) | 470.2 – 550 MHz | Art. no. 509426

EW-DX SKM (R1-9) | 520 – 607.8 MHz | Art. no. 509427

EW-DX SKM (S1-10) | 606.2 – 693.8 MHz | Art. no. 509428

EW-DX SKM (S2-10) | 614.2 – 693.8 MHz | Art. no. 509431

EW-DX SKM (S4-10) | 630 – 693.8 MHz | Art. no. 509432

EW-DX SKM (U1/5) | 823.2 – 831.8 MHz & 863.2 – 864.8 MHz | Art. no. 509433

EW-DX SKM (V3-4) | 925.2 – 937.3 MHz | Art. no. 509435

EW-DX SKM (V5-7) | 941.7 – 951.8 MHz & 953.05 – 956.05 MHz & 956.65 – 959.65 MHz |
Art. no. 509436

EW-DX SKM (Y1-3) | 1785.2 – 1799.8 MHz | Art. no. 509439



Handheld transmitter with mute switch

The **EW-DX SKM-S** handheld transmitter with mute switch is available in the following versions:

EW-DX SKM-S (Q1-9) | 470.2 – 550 MHz | Art. no. 509412

EW-DX SKM-S (R1-9) | 520 – 607.8 MHz | Art. no. 509413

EW-DX SKM-S (S1-10) | 606.2 – 693.8 MHz | Art. no. 509414

EW-DX SKM-S (S2-10) | 614.2 – 693.8 MHz | Art. no. 509417

EW-DX SKM-S (S4-10) | 630 – 693.8 MHz | Art. no. 509418

EW-DX SKM-S (U1/5) | 823.2 – 831.8 MHz & 863.2 – 864.8 MHz | Art. no. 509419

EW-DX SKM-S (V3-4) | 925.2 – 937.3 MHz | Art. no. 509421

EW-DX SKM-S (V5-7) | 941.7 – 951.8 MHz & 953.05 – 956.05 MHz & 956.65 – 959.65 MHz | Art. no. 509422

EW-DX SKM-S (Y1-3) | 1785.2 – 1799.8 MHz | Art. no. 509423

i You can find more detailed information about the EW-DX SKM and EW-DX SKM-S in the following sections:

- **Startup and operation:** [EW-DX SKM](#) | [EW-DX SKM-S handheld transmitter](#)
- **Specifications:** [EW-DX SKM](#) | [EW-DX SKM-S handheld transmitter](#)
- **Compatible microphone modules:** [Replacing the microphone module](#)



EW-DX SK | EW-DX SK 3-PIN bodypack transmitter



EW-DX SK bodypack transmitter

The **EW-DX SK** bodypack transmitter is available in the following versions:

EW-DX SK (Q1-9) | 470.2 – 550 MHz | Art. no. 509384

EW-DX SK (R1-9) | 520 – 607.8 MHz | Art. no. 509385

EW-DX SK (S1-10) | 606.2 – 693.8 MHz | Art. no. 509385

EW-DX SK (S2-10) | 614.2 – 693.8 MHz | Art. no. 509389

EW-DX SK (S4-10) | 630 – 693.8 MHz | Art. no. 509390

EW-DX SK (U1/5) | 823.2 – 831.8 MHz & 863.2 – 864.8 MHz | Art. no. 509391

EW-DX SK (V3-4) | 925.2 – 937.3 MHz | Art. no. 509393

EW-DX SK (V5-7) | 941.7 – 951.8 MHz & 953.05 – 956.05 MHz & 956.65 – 959.65 MHz | Art. no. 509394

EW-DX SK (Y1-3) | 1785.2 – 1799.8 MHz | Art. no. 509397

EW-DX SK 3-PIN bodypack transmitter

The **EW-DX SK 3-PIN** bodypack transmitter is available in the following versions:

EW-DX SK 3-PIN (Q1-9) | 470.2 – 550 MHz | Art. no. 509398



EW-DX SK 3-PIN (R1-9) | 520 – 607.8 MHz | Art. no. 509399

EW-DX SK 3-PIN (S1-10) | 606.2 – 693.8 MHz | Art. no. 509499

EW-DX SK 3-PIN (S2-10) | 614.2 – 693.8 MHz | Art. no. 509403

EW-DX SK 3-PIN (S4-10) | 630 – 693.8 MHz | Art. no. 509404

EW-DX SK 3-PIN (U1/5) | 823.2 – 831.8 MHz & 863.2 – 864.8 MHz | Art. no. 509405

EW-DX SK 3-PIN (V3-4) | 925.2 – 937.3 MHz | Art. no. 509407

EW-DX SK 3-PIN (V5-7) | 941.7 – 951.8 MHz & 953.05 – 956.05 MHz & 956.65 – 959.65 MHz
| Art. no. 509408

EW-DX SK 3-PIN (Y1-3) | 1785.2 – 1799.8 MHz | Art. no. 509411

i You can find more detailed information about the EW-DX SK and EW-DX SK 3-PIN in the following sections:

- **Startup and operation:** [EW-DX SK](#) | [EW-DX SK 3-PIN bodypack transmitter](#)
- **Specifications:** [EW-DX SK](#) | [EW-DX SK 3-PIN bodypack transmitter](#)
- **Compatible microphones:** [Connecting a microphone to the bodypack transmitter](#)



Table stand EW-DX TS 3-pin | EW-DX TS 5-pin



Table stand EW-DX TS 3-pin

The **EW-DX TS 3-pin** table stand is available in the following versions:

EW-DX TS 3-pin (Q1-9) | 470.2 – 550 MHz | Art. no. 509440

EW-DX TS 3-pin (R1-9) | 520 – 607.8 MHz | Art. no. 509441

EW-DX TS 3-pin (S1-10) | 606.2 – 693.8 MHz | Art. no. 509442

EW-DX TS 3-pin (S2-10) | 614.2 – 693.8 MHz | Art. no. 509445

EW-DX TS 3-pin (S4-10) | 630 – 693.8 MHz | Art. no. 509446

EW-DX TS 3-pin (U1/5) | 823.2 – 831.8 MHz & 863.2 – 864.8 MHz | Art. no. 509447

EW-DX TS 3-pin (V3-4) | 925.2 – 937.3 MHz | Art. no. 509449

EW-DX TS 3-pin (V5-7) | 941.7 – 951.8 MHz & 953.05 – 956.05 MHz & 956.65 – 959.65 MHz |
Art. no. 509450

EW-DX TS 3-pin (Y1-3) | 1785.2 – 1799.8 MHz | Art. no. 509453

Table stand EW-DX TS 5-pin

The **EW-DX TS 5-pin** table stand is available in the following versions:

EW-DX TS 5-pin (Q1-9) | 470.2 – 550 MHz | Art. no. 700191

EW-DX TS 5-pin (R1-9) | 520 – 607.8 MHz | Art. no. 700192



EW-DX TS 5-pin (S1-10) | 606.2 – 693.8 MHz | Art. no. 700193

EW-DX TS 5-pin (S2-10) | 614.2 – 693.8 MHz | Art. no. 700195

EW-DX TS 5-pin (S4-10) | 630 – 693.8 MHz | Art. no. 700196

EW-DX TS 5-pin (U1/5) | 823.2 – 831.8 MHz & 863.2 – 864.8 MHz | Art. no. 700197

EW-DX TS 5-pin (V3-4) | 925.2 – 937.3 MHz | Art. no. 700199

EW-DX TS 5-pin (V5-7) | 941.7 – 951.8 MHz & 953.05 – 956.05 MHz & 956.65 – 959.65 MHz |
Art. no. 700200

EW-DX TS 5-pin (Y1-3) | 1785.2 – 1799.8 MHz | Art. no. 700203

i You can find more detailed information about the EW-DX TS in the following sections:

- **Startup and operation:** [Table stand EW-DX TS 3-pin | EW-DX TS 5-pin](#)
- **Specifications:** [Table stand EW-DX TS 3-pin | EW-DX TS 5-pin](#)
- **Compatible microphones:** [Connecting a gooseneck microphone](#)



Sets available for the EW-DX series

Related information

[EW-DX 835-S SET | Handheld Set](#)

[EW-DX MKE 2 SET | Lavalier Set](#)

[EW-DX MKE 2-835-S SET | Combo Set](#)

EW-DX 835-S SET | Handheld Set



The set consists of the following components:

- **EW-DX EM 2** rack receiver
- 2x **EW-DX SKM-S** handheld transmitters
- 2x **MMD 835** microphone module
- 2x **BA 70** rechargeable batteries

The set is available in the following versions:

EW-DX 835-S SET (Q1-9) | 470.2 – 550 MHz | Art. no. 509300

EW-DX 835-S SET (R1-9) | 520 – 607.8 MHz | Art. no. 509301

EW-DX 835-S SET (S1-10) | 606.2 – 693.8 MHz | Art. no. 509302

EW-DX 835-S SET (S2-10) | 614.2 – 693.8 MHz | Art. no. 509305

EW-DX 835-S SET (S4-10) | 630 – 693.8 MHz | Art. no. 509306



EW-DX 835-S SET (U1/5) | 823.2 – 831.8 MHz & 863.2 – 864.8 MHz | Art. no. 509307

EW-DX 835-S SET (V3-4) | 925.2 – 937.3 MHz | Art. no. 509309

EW-DX 835-S SET (V5-7) | 941.7 – 951.8 MHz & 953.05 – 956.05 MHz & 956.65 – 959.65 MHz | Art. no. 509310

EW-DX 835-S SET (Y1-3) | 1785.2 – 1799.8 MHz | Art. no. 509313

i You can find more detailed information about the set in the following sections:

- **Startup and operation:** [Instruction manual](#)
- **Specifications:** [Specifications](#)



EW-DX MKE 2 SET | Lavalier Set



The set consists of the following components:

- **EW-DX EM** rack receiver
- 2x **EW-DX SK** bodypack transmitter
- 2x **MKE 2** lavalier microphone
- 2x **BA 70** rechargeable batteries

The set is available in the following versions:

EW-DX MKE 2 SET (Q1-9) | 470.2 – 550 MHz | Art. no. 509314

EW-DX MKE 2 SET (R1-9) | 520 – 607.8 MHz | Art. no. 509315

EW-DX MKE 2 SET (S1-10) | 606.2 – 693.8 MHz | Art. no. 509316

EW-DX MKE 2 SET (S2-10) | 614.2 – 693.8 MHz | Art. no. 509319

EW-DX MKE 2 SET (S4-10) | 630 – 693.8 MHz | Art. no. 509320

EW-DX MKE 2 SET (U1/5) | 823.2 – 831.8 MHz & 863.2 – 864.8 MHz | Art. no. 509321

EW-DX MKE 2 SET (V3-4) | 925.2 – 937.3 MHz | Art. no. 509323

EW-DX MKE 2 SET (V5-7) | 941.7 – 951.8 MHz & 953.05 – 956.05 MHz & 956.65 – 959.65 MHz | Art. no. 509324

EW-DX MKE 2 SET (Y1-3) | 1785.2 – 1799.8 MHz | Art. no. 509327



i You can find more detailed information about the set in the following sections:

- **Startup and operation:** [Instruction manual](#)
- **Specifications:** [Specifications](#)



EW-DX MKE 2-835-S SET | Combo Set



The set consists of the following components:

- **EW-DX EM** rack receiver
- 1x **EW-DX SK** bodypack transmitter
- 1x **MKE 2** lavalier microphone
- 1x **EW-DX SKM-S** handheld transmitter
- 1x **MMD 835** microphone module
- 2x **BA 70** rechargeable batteries

The set is available in the following versions:

EW-DX MKE 2-835-S SET (Q1-9) | 470.2 – 550 MHz | Art. no. 509328

EW-DX MKE 2-835-S SET (R1-9) | 520 – 607.8 MHz | Art. no. 509329

EW-DX MKE 2-835-S SET (S1-10) | 606.2 – 693.8 MHz | Art. no. 509330

EW-DX MKE 2-835-S SET (S2-10) | 614.2 – 693.8 MHz | Art. no. 509333

EW-DX MKE 2-835-S SET (S4-10) | 630 – 693.8 MHz | Art. no. 509334

EW-DX MKE 2-835-S SET (U1/5) | 823.2 – 831.8 MHz & 863.2 – 864.8 MHz | Art. no. 509335



EW-DX MKE 2-835-S SET (V3-4) | 925.2 – 937.3 MHz | Art. no. 509337

EW-DX MKE 2-835-S SET (V5-7) | 941.7 – 951.8 MHz & 953.05 – 956.05 MHz & 956.65 – 959.65 MHz | Art. no. 509338

EW-DX MKE 2-835-S SET (Y1-3) | 1785.2 – 1799.8 MHz | Art. no. 509341

i You can find more detailed information about the set in the following sections:

- **Startup and operation:** [Instruction manual](#)
- **Specifications:** [Specifications](#)



EW-DX SK-SKM-S BASE SET | Base Set



The set consists of the following components:

- **EW-DX EM** rack receiver
- 1x **EW-DX SK** bodypack transmitter
- 1x **EW-DX SKM-S** handheld transmitter
- 2x **BA 70** rechargeable batteries

The set is available in the following versions:

EW-DX SK-SKM-S BASE SET (Q1-9) | 470.2 – 550 MHz | Art. no. 509462

EW-DX SK-SKM-S BASE SET (R1-9) | 520 – 607.8 MHz | Art. no. 509463

EW-DX SK-SKM-S BASE SET (S1-10) | 606.2 – 693.8 MHz | Art. no. 509464

EW-DX SK-SKM-S BASE SET (S2-10) | 614.2 – 693.8 MHz | Art. no. 509467

EW-DX SK-SKM-S BASE SET (S4-10) | 630 – 693.8 MHz | Art. no. 509468

EW-DX SK-SKM-S BASE SET (U1/5) | 823.2 – 831.8 MHz & 863.2 – 864.8 MHz | Art. no. 509469

EW-DX SK-SKM-S BASE SET (V3-4) | 925.2 – 937.3 MHz | Art. no. 509471

EW-DX SK-SKM-S BASE SET (V5-7) | 941.7 – 951.8 MHz & 953.05 – 956.05 MHz & 956.65 – 959.65 MHz | Art. no. 509338



EW-DX SK-SKM-S BASE SET (Y1-3) | 1785.2 – 1799.8 MHz | Art. no. 509341

i You can find more detailed information about the set in the following sections:

- **Startup and operation:** [Instruction manual](#)
- **Specifications:** [Specifications](#)



Products of the EW-DP series



For information about the available **accessories**, see [Accessories](#).

For information about the available **sets**, see [Sets available for the EW-DP series](#).

For information about the **frequency ranges**, see [Frequency ranges](#).

You can find technical **specifications** for the series and the individual products under [Specifications](#).

You can find information about **starting up** and **operating** the products under [Instruction manual](#).



EW-DP EK portable receiver



The **EW-DP EK** portable receiver is available in the following versions:

EW-DP EK (Q1-6) | 470.2 – 526 MHz | Art. no. 700050

EW-DP EK (R1-6) | 520 – 576 MHz | Art. no. 700051

EW-DP EK (R4-9) | 552 – 607.8 MHz | Art. no. 700052

EW-DP EK (S1-7) | 606.2 – 662 MHz | Art. no. 700053

EW-DP EK (S4-7) | 630 – 662 MHz | Art. no. 700054

EW-DP EK (S7-10) | 662 – 693.8 MHz | Art. no. 700055

EW-DP EK (U1/5) | 823.2 – 831.8 MHz & 863.2 – 864.8 MHz | Art. no. 700056

EW-DP EK (V3-4) | 925.2 – 937.3 MHz | Art. no. 700058

EW-DP EK (Y1-3) | 1785.2 – 1799.8 MHz | Art. no. 700059

i You can find more detailed information about the EW-DP EK in the following sections:

- **Startup and operation:** [EW-DP EK portable receiver](#)
- **Specifications:** [EW-DP EK portable receiver](#)



EW-DP SKP plug-on transmitter



The **EW-DP SKP** plug-on transmitter is available in the following versions:

EW-DP SKP (Q1-6) | 470.2 – 526 MHz | Art. no. 700080

EW-DP SKP (R1-6) | 520 – 576 MHz | Art. no. 700081

EW-DP SKP (R4-9) | 552 – 607.8 MHz | Art. no. 700082

EW-DP SKP (S1-7) | 606.2 – 662 MHz | Art. no. 700083

EW-DP SKP (S4-7) | 630 – 662 MHz | Art. no. 700084

EW-DP SKP (S7-10) | 662 – 693.8 MHz | Art. no. 700085

EW-DP SKP (U1/5) | 823.2 – 831.8 MHz & 863.2 – 864.8 MHz | Art. no. 700086

EW-DP SKP (V3-4) | 925.2 – 937.3 MHz | Art. no. 700088

EW-DP SKP (Y1-3) | 1785.2 – 1799.8 MHz | Art. no. 700089

i You can find more detailed information about the EW-DP SKP in the following sections:

- **Startup and operation:** [EW-DP EK portable receiver](#)
- **Specifications:** [EW-DP SKP plug-on transmitter](#)



Sets available for the EW-DP series

Related information

[EW-DP ME-2 | Lavalier Set](#)

[EW-DP ME-4 | Lavalier Set](#)

[EW-DP 835 | Handheld Set](#)

[EW-DP ENG | Lavalier Set](#)

EW-DP ME-2 | Lavalier Set



The set consists of the following components:

- **EW-DP EK** portable receiver
- **EW-D SK** bodypack transmitter
- **ME 2** lavalier microphone

The set is available in the following versions:

EW-DP ME-2 SET (Q1-6) | 470.2 – 526 MHz | Art. no. 508710

EW-DP ME-2 SET (R1-6) | 520 – 576 MHz | Art. no. 508711

EW-DP ME-2 SET (R4-9) | 552 – 607.8 MHz | Art. no. 508712



EW-DP ME-2 SET (S1-7) | 606.2 – 662 MHz | Art. no. 508713

EW-DP ME-2 SET (S4-7) | 630 – 662 MHz | Art. no. 508714

EW-DP ME-2 SET (S7-10) | 662 – 693.8 MHz | Art. no. 508715

EW-DP ME-2 SET (U1/5) | 823.2 – 831.8 MHz & 863.2 – 864.8 MHz | Art. no. 508716

EW-DP ME-2 SET (V3-4) | 925.2 – 937.3 MHz | Art. no. 508718

EW-DP ME-2 SET (Y1-3) | 1785.2 – 1799.8 MHz | Art. no. 508719

i You can find more detailed information about the set in the following sections:

- **Startup and operation:** [Instruction manual](#)
- **Specifications:** [Specifications](#)



EW-DP ME-4 | Lavalier Set



The set consists of the following components:

- **EW-DP EK** portable receiver
- **EW-D SK** bodypack transmitter
- **ME 4** lavalier microphone

The set is available in the following versions:

EW-DP ME-4 SET (Q1-6) | 470.2 – 526 MHz | Art. no. 508720

EW-DP ME-4 SET (R1-6) | 520 – 576 MHz | Art. no. 508721

EW-DP ME-4 SET (R4-9) | 552 – 607.8 MHz | Art. no. 508722

EW-DP ME-4 SET (S1-7) | 606.2 – 662 MHz | Art. no. 508723

EW-DP ME-4 SET (S4-7) | 630 – 662 MHz | Art. no. 508724

EW-DP ME-4 SET (S7-10) | 662 – 693.8 MHz | Art. no. 508725

EW-DP ME-4 SET (U1/5) | 823.2 – 831.8 MHz & 863.2 – 864.8 MHz | Art. no. 508726

EW-DP ME-4 SET (V3-4) | 925.2 – 937.3 MHz | Art. no. 508728

EW-DP ME-4 SET (Y1-3) | 1785.2 – 1799.8 MHz | Art. no. 508729



i You can find more detailed information about the set in the following sections:

- **Startup and operation:** [Instruction manual](#)
- **Specifications:** [Specifications](#)



EW-DP 835 | Handheld Set



The set consists of the following components:

- **EW-DP EK** portable receiver
- **EW-D SKM-S** handheld transmitter
- **MMD 835** microphone module

The set is available in the following versions:

EW-DP 835 SET (Q1-6) | 470.2 – 526 MHz | Art. no. 508730

EW-DP 835 SET (R1-6) | 520 – 576 MHz | Art. no. 508731

EW-DP 835 SET (R4-9) | 552 – 607.8 MHz | Art. no. 508732

EW-DP 835 SET (S1-7) | 606.2 – 662 MHz | Art. no. 508733

EW-DP 835 SET (S4-7) | 630 – 662 MHz | Art. no. 508734

EW-DP 835 SET (S7-10) | 662 – 693.8 MHz | Art. no. 508735



EW-DP 835 SET (U1/5) | 823.2 – 831.8 MHz & 863.2 – 864.8 MHz | Art. no. 508736

EW-DP 835 SET (V3-4) | 925.2 – 937.3 MHz | Art. no. 508738

EW-DP 835 SET (Y1-3) | 1785.2 – 1799.8 MHz | Art. no. 508739

i You can find more detailed information about the set in the following sections:

- **Startup and operation:** [Instruction manual](#)
- **Specifications:** [Specifications](#)



EW-DP ENG | Lavalier Set



The set consists of the following components:

- **EW-DP EK** portable receiver
- **EW-D SK** bodypack transmitter
- **EW-DP SKP** plug-on transmitter
- **ME 2** lavalier microphone

The set is available in the following versions:

EW-DP ENG SET (Q1-6) | 470.2 - 526 MHz | Art. no. 700040

EW-DP ENG SET (R1-6) | 520 - 576 MHz | Art. no. 700041

EW-DP ENG SET (R4-9) | 552 - 607.8 MHz | Art. no. 700042

EW-DP ENG SET (S1-7) | 606.2 - 662 MHz | Art. no. 700043

EW-DP ENG SET (S4-7) | 630 - 662 MHz | Art. no. 700044

EW-DP ENG SET (S7-10) | 662 - 693.8 MHz | Art. no. 700045

EW-DP ENG SET (U1/5) | 823.2 - 831.8 MHz & 863.2 - 864.8 MHz | Art. no. 700046

EW-DP ENG SET (V3-4) | 925.2 - 937.3 MHz | Art. no. 700048

EW-DP ENG SET (Y1-3) | 1785.2 - 1799.8 MHz | Art. no. 700049



i You can find more detailed information about the set in the following sections:

- **Startup and operation:** [Instruction manual](#)
- **Specifications:** [Specifications](#)



Smart Assist app

You can operate your products easily and intuitively using the **Smart Assist** app for iOS and Android.

You can make all device settings in the app and access other functions that are not available on the devices themselves.



The app offers you the following benefits:

- Use all products easily and intuitively
- Update the firmware of all devices
- Easily configure multi-channel systems with automatic frequency setup
- Assign names and color labels to wireless links
- Get tips and support



Accessories

Related information

[BA 70 rechargeable battery and L 70 USB charger](#)

[CHG 70N-C network-enabled charger](#)

[EW-D ASA antenna splitter](#)

[EW-D AB antenna splitter](#)

[Antennas](#)

[Accessories for rack mounting](#)

[Mounting accessories for EW-DP EK](#)

[Cables for EW-DP EK](#)

[Color Coding Sets](#)

BA 70 rechargeable battery and L 70 USB charger



BA 70 | Rechargeable battery | Art. no. 508860

L 70 USB | Charger | Art. no. 508861

EW-D CHARGING SET | L 70 USB charger with two BA 70 rechargeable batteries | Art. no. 508862



i You can find more detailed information about the BA 70 rechargeable battery and the L 70 USB charger in the following sections:

- **Startup and operation:** [L 70 USB charger](#)
- **Specifications:** [BA 70 rechargeable battery](#) | [L 70 USB charger](#)



CHG 70N-C network-enabled charger



CHG 70N-C | Charger | Art. no. 700332



CHG 70N-C + PSU KIT | CHG 70N-C charger with NT 12-35 CS power supply unit | Art. no. 700333

i You can find more detailed information about the CHG 70N-C in the following sections:

- **Startup and operation:** [CHG 70N-C charger](#)
- **Specifications:** [BA 70 rechargeable battery](#) | [CHG 70N-C charger](#)



EW-D ASA antenna splitter



EW-D ASA active antenna splitter

Product versions:

EW-D ASA (Q-R-S) | 470 – 694 MHz | Art. no. 508879

EW-D ASA CN/ANZ (Q-R-S) | 470 – 694 MHz | Art. no. 508998

EW-D ASA (T-U-V-W) | 694 – 1075 MHz | Art. no. 508880

EW-D ASA (X-Y) | 1350 – 1805 MHz | Art. no. 508881

i You can find more detailed information about the EW-D ASA in the following sections:

- **Startup and operation:** [EW-D ASA antenna splitter](#)
- **Specifications:** [EW-D ASA antenna splitter](#)



EW-D AB antenna splitter



EW-D ASA active antenna splitter

Product versions:

EW-D AB (Q) | 470 – 550 MHz | Art. no. 508873

EW-D AB (R) | 520 – 608 MHz | Art. no. 508874

EW-D AB (S) | 606 – 694 MHz | Art. no. 508875

EW-D AB (U) | 823 – 865 MHz | Art. no. 508876

EW-D AB (V) | 902 – 960 MHz | Art. no. 508877

EW-D AB (Y) | 1785 – 1805 MHz | Art. no. 508878

i You can find more detailed information about the EW-D AB in the following sections:

- **Use:** [Information on antenna amplifiers and cable lengths](#)
- **Specifications:** [EW-D AB antenna booster](#)



Antennas

Rod antennas

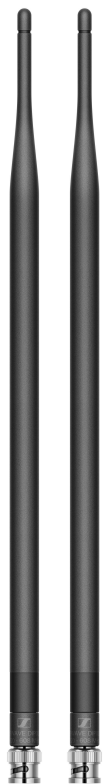

Product versions:

Half Wave Dipole (Q) | 470 – 550 MHz | Art. no. 508868

Half Wave Dipole (R) | 520 – 608 MHz | Art. no. 508869

Half Wave Dipole (S) | 606 – 694 MHz | Art. no. 508870

Half Wave Dipole (U) | 823 – 865 MHz | Art. no. 508871

Half Wave Dipole (V) | 902 – 960 MHz | Art. no. 508966

Half Wave Dipole (Y) | 1785 – 1805 MHz | Art. no. 508872



AWM active directional antenna



Product versions:

AWM UHF I | 470 – 694 MHz | Art. no. 508865

AWM UHF II | 823 – 1075 MHz | Art. no. 508866

AWM 1G8 | 1785 – 1805 MHz | Art. no. 508867

i You can find more detailed information about the AWM antenna in the following sections:

- **Startup and operation:** [AWM active directional antenna](#)
- **Specifications:** [AWM active directional antenna](#)



ADP UHF passive directional antenna (470 – 1075 MHz)



ADP UHF | 470 – 1075 MHz | Art. no. 508863

i Specifications: [ADP UHF passive directional antenna \(470 – 1075 MHz\)](#)



AD 1800 passive directional antenna



AD 1800 | 1400 – 2400 MHz | Art. no. 504916



Accessories for rack mounting

GA 3 rack mount kit

19" rack adapter for mounting the EW-D EM, EW-DX EM 2 or EW-D ASA in a 19" rack.

Art. no. 503167



AM 2 antenna front mount kit

Antenna front mount kit for installing antenna connections on the front of the rack when using the EW-D EM, EW-DX EM 2 or EW-D ASA together with the GA 3 rack mount kit.

Art. no. 009912





Mounting accessories for EW-DP EK



Product versions:

Mounting plate (single) | Art. no. 588188

Mounting plate set | Art. no. 700005

i Mounting kit for attaching the EW-DP EK portable receiver to cameras, cages or sound bags.

- **Startup and operation:** [EW-DP EK portable receiver](#)



Cables for EW-DP EK

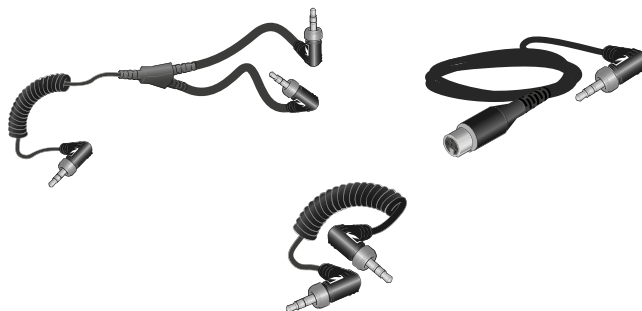

CL 35 | 3.5 mm jack cable | Art no. 586365

CL 35-Y | 3.5 mm Y-cable | Art. no. 700061

CL 35 XLR | 3.5 mm XLR cable | Art. no. 700062

i 3.5 mm jack cable, 3.5 mm Y-cable and 3.5 mm XLR cable for connecting one or more EW-DP EK units to a camera.

- **Startup and operation:** [EW-DP EK portable receiver](#)



Color Coding Sets

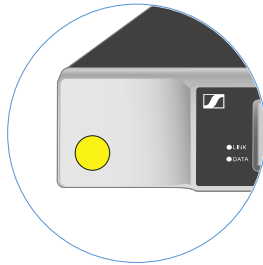

EM



SKM-S



SK

EW-D COLOR CODING SET | For EM, SKM-S, SK | Art. no. 508989

EW-D SK COLOR CODING | For SK | Art. no. 508990

EW-D SKM COLOR CODING | For SKM-S | Art. no. 508991

EW-D EM COLOR CODING | For EM | Art. no. 508992

i [Using EW-D Color Coding Sets to label transmission paths](#)



Frequency ranges

i Frequency tables with the factory presets for all available frequency ranges can be found in the download area of the Sennheiser website at:

sennheiser.com/download

- Enter **EW-D**, **EW-DX** or **EW-DP** in the search bar to show the frequency tables.

EW-D | EW-DP

The products **EW-D EM**, **EW-D SKM-S**, **EW-D SK**, **EW-DP EK** and **EW-DP SKP** are available in the following frequency ranges:

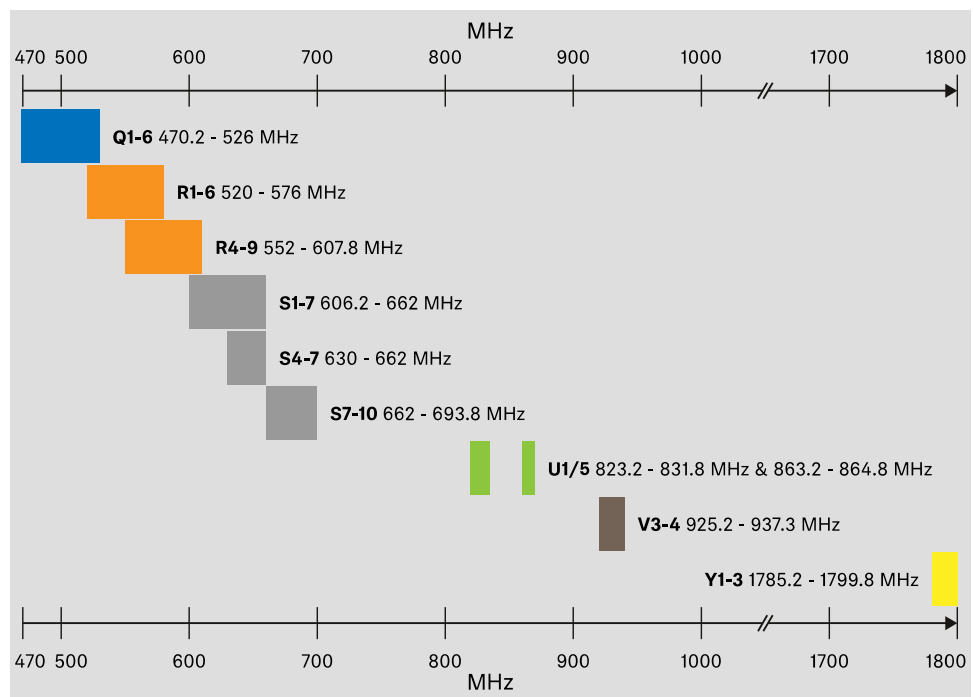



EW-DX

The products **EW-DX EM 2**, **EW-DX EM 2 Dante**, **EW-DX EM 4 Dante**, **EW-DX SKM**, **EW-DX SKM-S**, **EW-DX SK**, **EW-D SK 3-PIN**, **EW-DX TS 3-pin** and **EW-DX TS 5-pin** are available in the following frequency ranges:

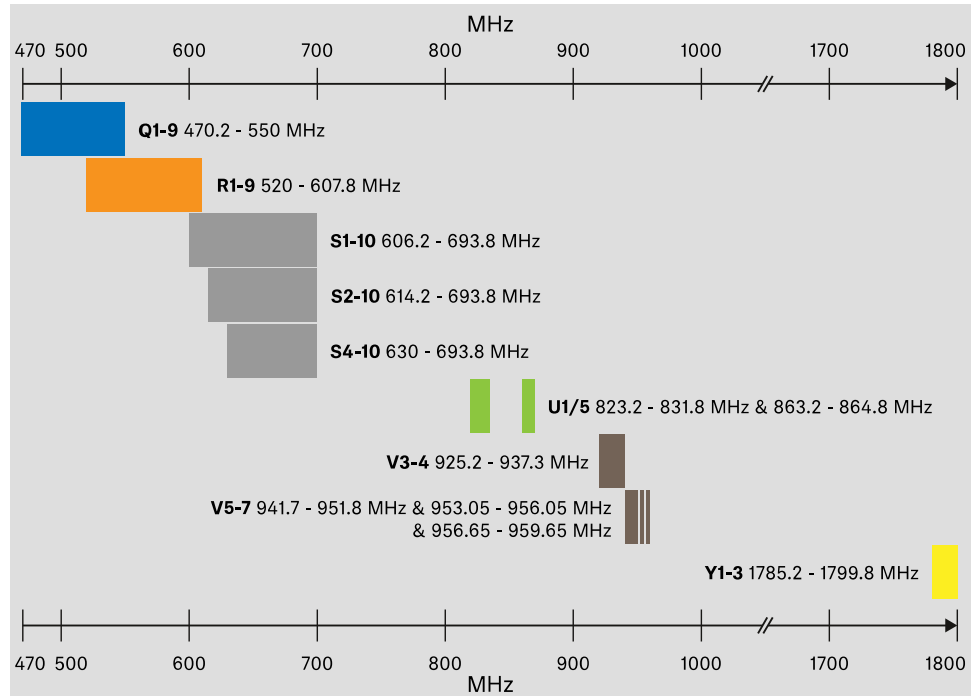

Accessories

The **EW-D AB** antenna booster and the **Half Wave Dipole** rod antennas are available in the following frequency ranges:

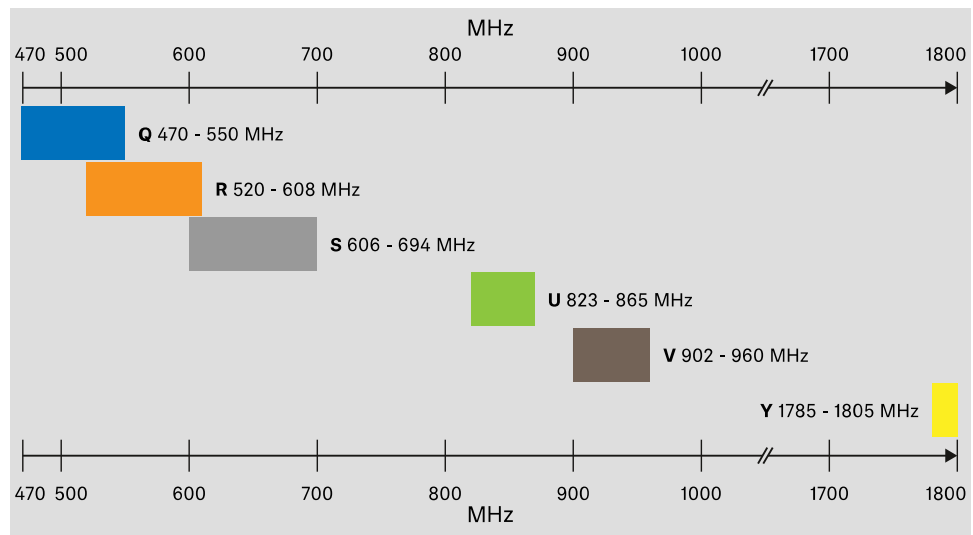



The **EW-D ASA** antenna splitter is available in the following frequency ranges:

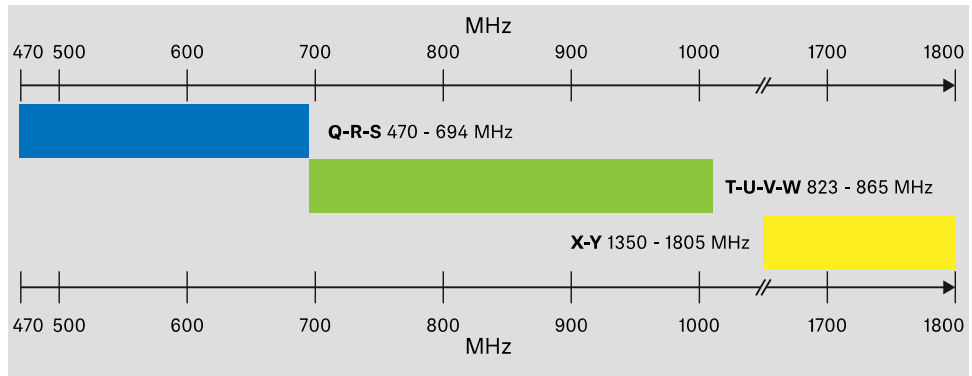



3. Instruction manual

Starting up and operating devices of the Evolution Wireless Digital series.

Products of the EW-D series

[EW-D EM rack receiver](#)

[EW-D SKM-S handheld transmitter](#)

[EW-D SK bodypack transmitter](#)

Products of the EW-DX series

[EW-DX EM 2 rack receiver](#)

[EW-DX EM 2 Dante rack receiver](#)

[EW-DX EM 4 Dante rack receiver](#)

[EW-DX SKM | EW-DX SKM-S handheld transmitter](#)

[EW-DX SK | EW-DX SK 3-PIN bodypack transmitter](#)

[Table stand EW-DX TS 3-pin | EW-DX TS 5-pin](#)

Products of the EW-DP series

[EW-DP EK portable receiver](#)

[EW-DP SKP plug-on transmitter](#)

Establishing a radio link and synchronizing devices / Compatibility between EW-D, EW-DX and EW-DP

[Establishing a radio link | Synchronizing the receiver and transmitter](#)

Accessories

[L 70 USB charger](#)

[CHG 70N-C charger](#)

[EW-D ASA antenna splitter](#)

[AWM active directional antenna](#)

Cleaning and maintenance

[Cleaning and maintenance](#)



EW-D EM rack receiver

- Product overview
- Connecting/disconnecting the receiver to/from the power supply system
- Connecting antennas
- Outputting audio signals
- Installing receivers in a rack
- Switching the receiver on and off
- Lock-off function
- Meaning of the LEDs
- Displays on the receiver's display panel
- Buttons for navigating the menu
- Opening the menu and navigating the menu items
- GAIN menu item
- AF OUT menu item
- MUTE LOCK menu item
- AUTO SCAN menu item
- CHANNEL menu item
- TUNE menu item
- RESET menu item
- Using EW-D Color Coding Sets to label transmission paths

Product overview

Front

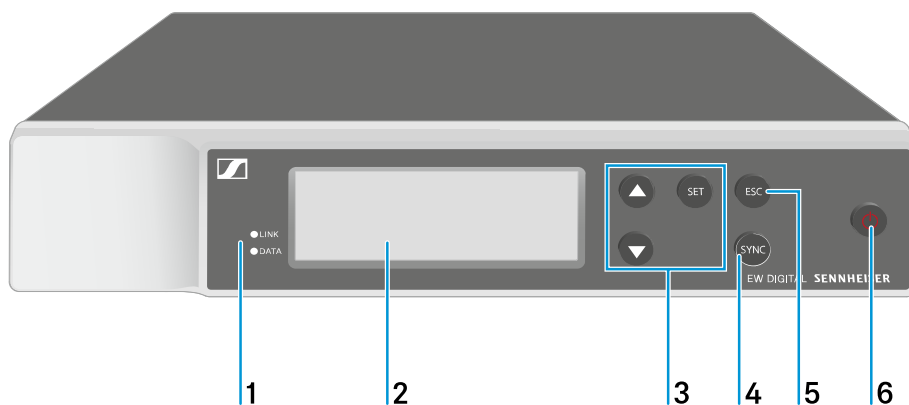



1 **LINK** and **DATA** LEDs to indicate connection status and Bluetooth status

- See [Meaning of the LEDs](#)

2 Display for status information and operating menu

- See [Displays on the receiver's display panel](#)

3 **UP/DOWN/SET** menu buttons for navigating the operating menu

- See [Buttons for navigating the menu](#)

4 **SYNC** button

- See [Establishing a radio link | Synchronizing the receiver and transmitter](#)

5 **ESC** button for canceling an action in the menu

- See [Buttons for navigating the menu](#)

6 **ON/OFF** button for switching the device on and off

- See [Switching the receiver on and off](#)

Back

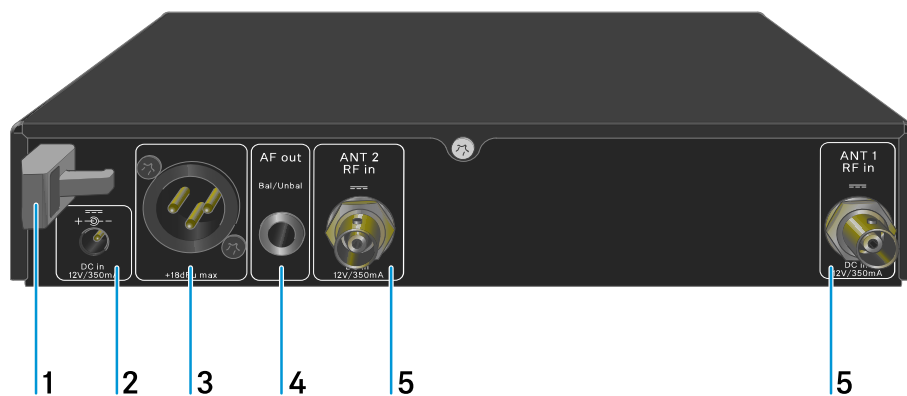



- 1 Strain relief for the connection cable of the power supply unit
 - See [Connecting/disconnecting the receiver to/from the power supply system](#)

- 2 **DC in** connection socket for the power supply unit
 - See [Connecting/disconnecting the receiver to/from the power supply system](#)

- 3 XLR-3 socket **AF out Bal** for audio output
 - See [Outputting audio signals](#)

- 4 6.3 mm jack socket **AF out Unbal** for audio output
 - See [Outputting audio signals](#)

- 5 BNC sockets **ANT 1 RF in** and **ANT 2 RF in** for antenna inputs
 - See [Connecting antennas](#)



Connecting/disconnecting the receiver to/from the power supply system

Use only the supplied power supply unit. It is designed for your receiver and ensures safe operation.

- i** You will find the power supply unit and the country adapters in the packaging under the tray:

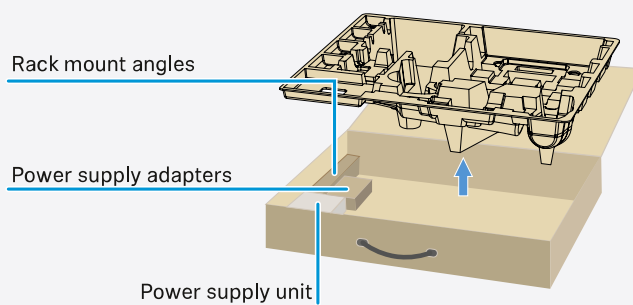

To connect the receiver to the power supply system:

- ▷ Insert the plug of the power supply unit into the **DC in** socket on the receiver.
- ▷ Pass the cable of the power supply unit through the strain relief.



- ▷ Slide the supplied country adapter onto the power supply unit.
- ▷ Plug the power supply unit into the wall socket.

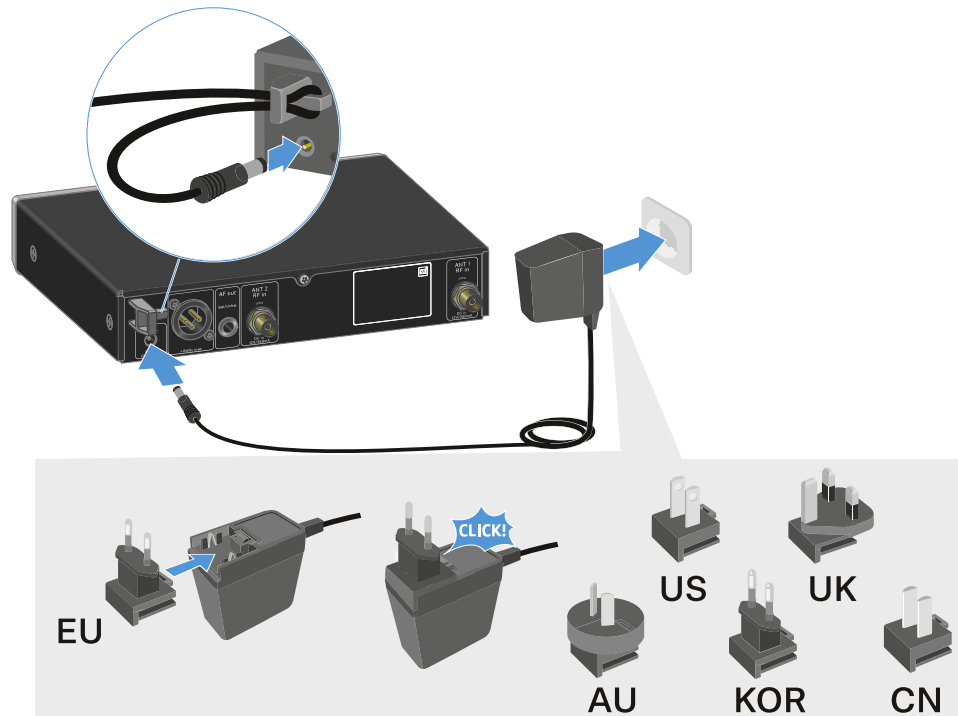

To completely disconnect the receiver from the power supply system:

- ▷ Unplug the power supply unit from the wall socket.
- ▷ Unplug the power supply unit from the **DC in** socket on the receiver.



Connecting antennas

To connect the supplied rod antennas:

- ▷ Connect the antennas to the two antenna inputs on the receiver as shown in the figure.
- ▷ Slightly angle the antennas to the left and right as shown in the figure.

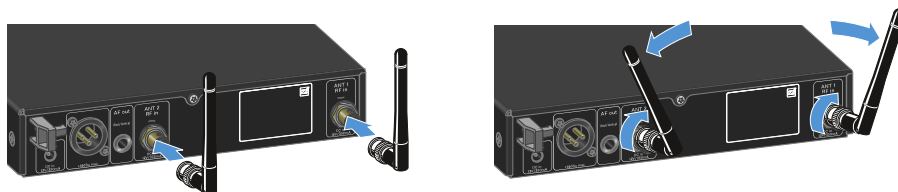

- i** If you are using more than one receiver, we recommend using remote antennas and possibly the [EW-D ASA antenna splitter](#) ([EW-D ASA antenna splitter](#)).



To connect remote antennas:

- ▷ Connect the antennas to the two antenna inputs on the receiver as shown in the figure.

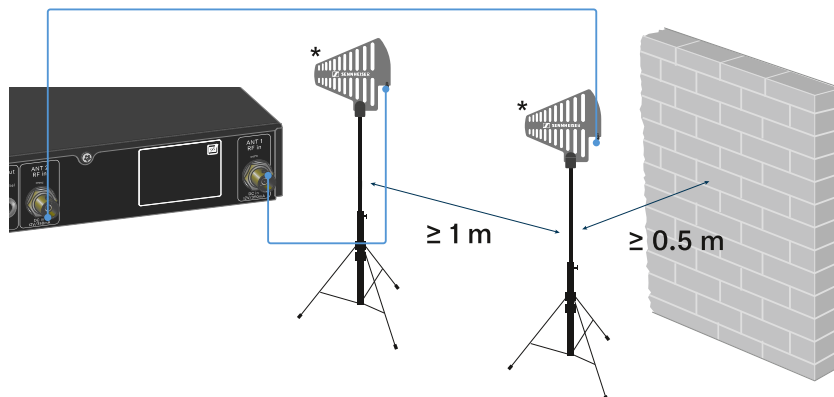

- ▷ Observe the specified minimum spacing.
- ▷ Observe the specified minimum spacing to the transmitters.

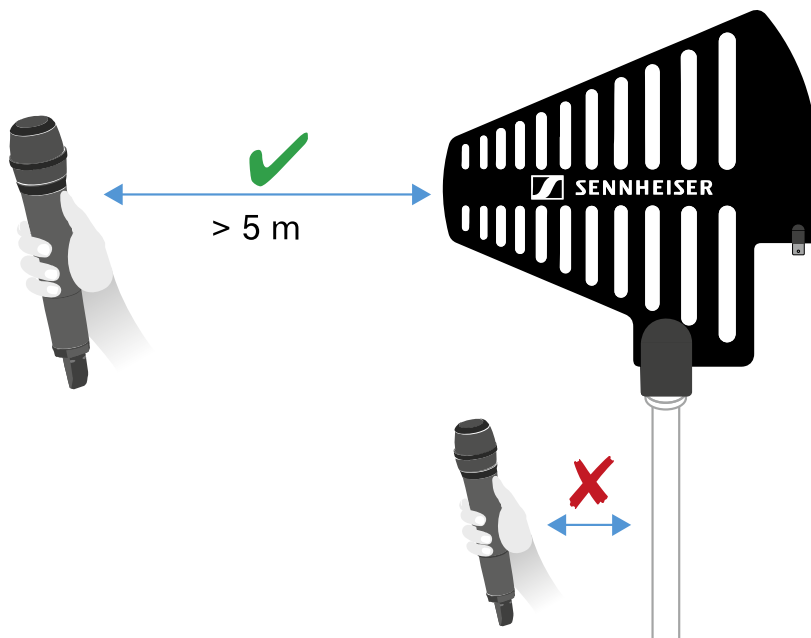

***Recommended antennas:**

- ADP UHF | 470 – 1075 MHz
- AD 1800 | 1400 – 2400 MHz

i If you are using more than one receiver, we recommend using remote antennas and possibly the EW-D ASA antenna splitter ([EW-D ASA antenna splitter](#)).



Outputting audio signals

The EW-D EM has a balanced XLR-3M output socket and an unbalanced 6.3 mm jack output socket.

- ▷ Always use only one of the two output sockets.

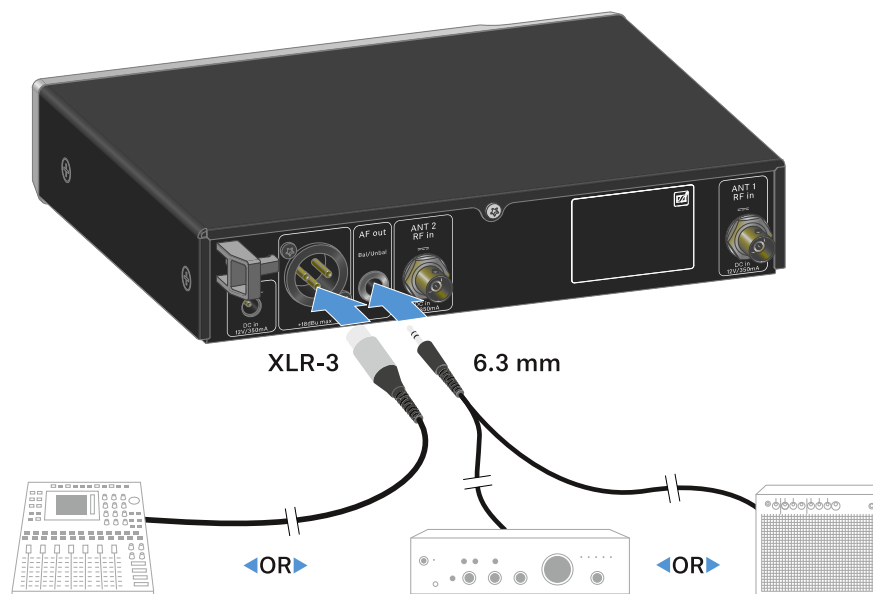

To connect an XLR cable:

- ▷ Plug the XLR cable into the **AF out Bal** socket on the EW-D EM.

To connect a jack cable:

- ▷ Plug the jack cable into the **AF out Unbal** socket on the EW-D EM.



Installing receivers in a rack

Observe the following instructions when mounting the receiver in a rack.

- i** The mounting brackets for installing the receiver in the rack can be found in the packaging under the tray:

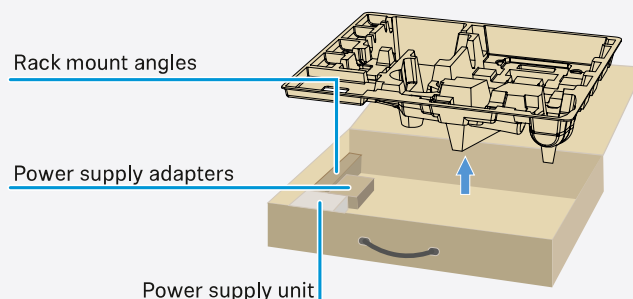

NOTICE



Rack mounting poses risks!

When installing the device in a closed 19" rack or multi-rack assembly, please consider that, during operation, the ambient temperature, the mechanical load and the electrical potentials will be different from those of devices which are not mounted into a rack.

- ▷ Make sure that the ambient temperature within the rack does not exceed the permissible temperature limit stated in the specifications. See ([Specifications](#)).
- ▷ Ensure sufficient ventilation; if necessary, provide additional ventilation.
- ▷ Make sure that the mechanical load of the rack is even.
- ▷ When connecting to the power supply system, observe the information indicated on the type plate. Avoid overloading the circuits. If necessary, provide overcurrent protection.
- ▷ When mounting in a rack, please note that intrinsically harmless leakage currents of the individual power supply units may accumulate, thereby exceeding the permissible limit value. As a remedy, ground the rack via an additional ground connection.



Mounting a single receiver in a rack:

- ▷ Connect the mounting brackets to the sides of the receiver as shown.

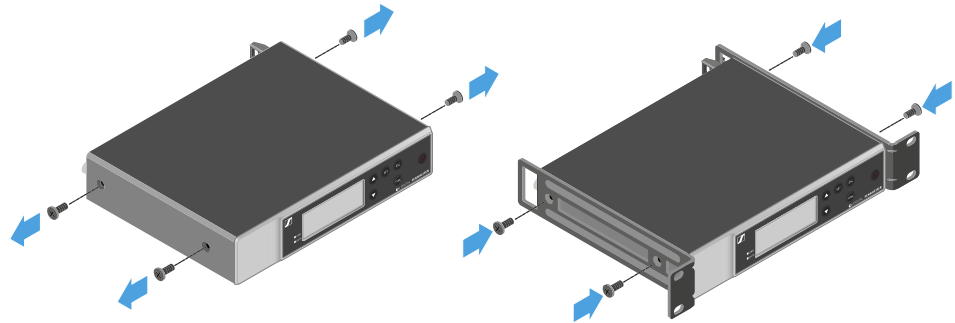

- ▷ Attach the front panel as shown.
- ▷ If desired, attach the antennas to the front panel as shown. This requires the optional AM 2 antenna front mount kit (see [Accessories for rack mounting](#)).

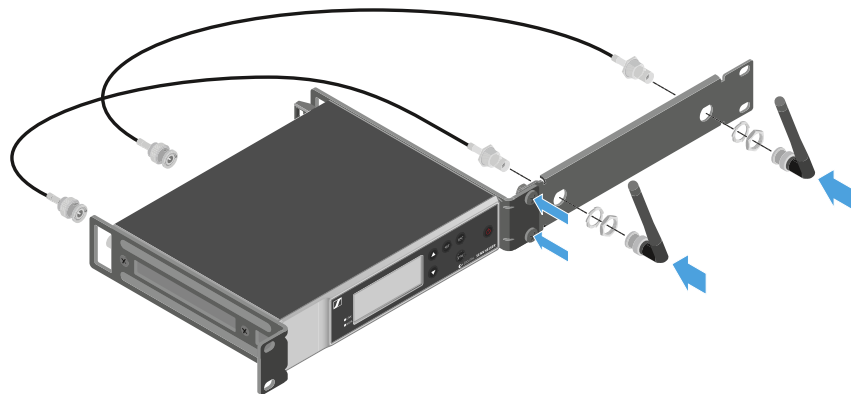



Mounting two receivers side by side in a rack

- ▷ Place both receivers upside down and side by side on an even surface.
- ▷ Tighten the jointing plate as shown.
- ▷ Attach the mounting brackets as shown.

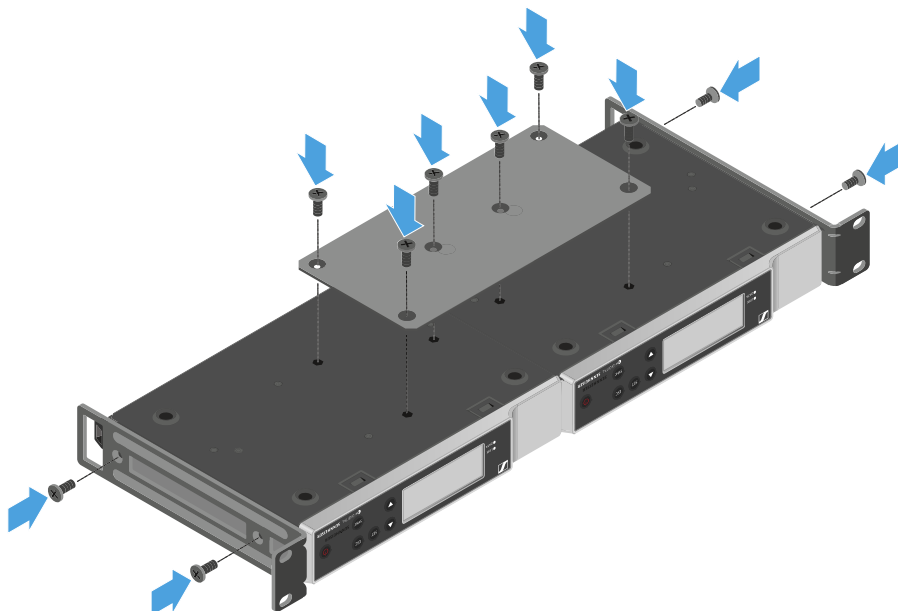



Switching the receiver on and off

To switch the receiver on:

- ▷ Short-press the **ON/OFF** button.
 - ➡ The receiver switches on.

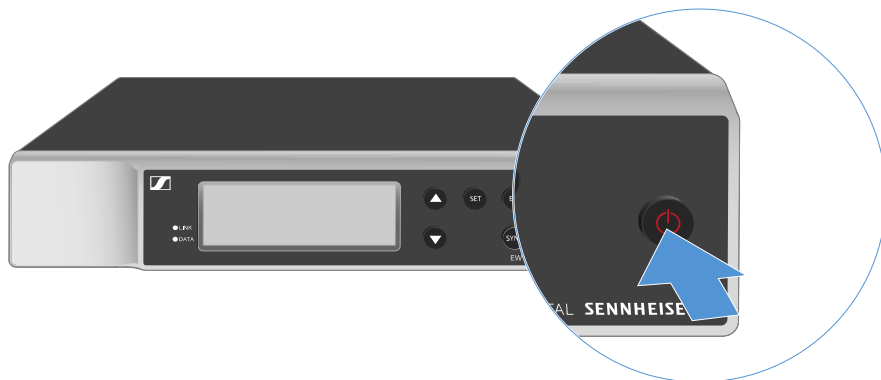

To switch the receiver to standby mode:

- ▷ If necessary, deactivate the lock-off function (see [Lock-off function](#)).
- ▷ Hold down the **ON/OFF** button until the display switches off.

To switch the receiver off completely:

- ▷ Disconnect the receiver from the power supply system by unplugging the power supply unit from the wall socket.



Lock-off function

To activate the key lock:

- ▷ Press the **UP** and **DOWN** buttons simultaneously.
 - ➔ Key lock is activated and the lock icon is shown on the display.

To deactivate the key lock:

- ▷ Simultaneously press the **UP** and **DOWN** buttons again.
 - ➔ Key lock is deactivated and the lock icon disappears from the display.



Meaning of the LEDs

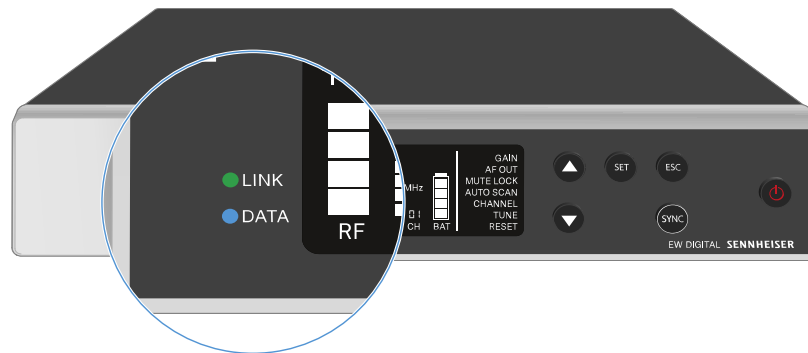

The **LINK** and **DATA** LEDs on the front of the receiver can indicate the following information.

LINK LED

The **LINK** LED provides information about the status of the radio link between the transmitter and receiver, as well as status information for the paired transmitter.

The LED is green:



- The link between the transmitter and receiver is established.
- The audio signal is active.

The LED is yellow:



- The link between the transmitter and receiver is established.
- The audio signal is muted.



or

- No microphone module is mounted on the SKM-S handheld transmitter.

The LED is flashing yellow:



- The link between the transmitter and receiver is established.
- The audio signal is overdriven (clipping).

The LED is continuously red:



- No link between the transmitter and receiver.

The LED is flashing red:



- The battery/rechargeable battery in the paired transmitter is low.

DATA LED

The **DATA** LED provides information on the receiver's **Bluetooth Low Energy** link to the **Smart Assist** app and on the synchronization of transmitters and receivers.

The LED is flashing blue:



- The **Bluetooth Low Energy** link is being established between the receiver and a smartphone or tablet with the **Smart Assist** app.

or

- The receiver is being synchronized with a transmitter.

The LED is blue:



- The firmware is being updated.

The LED is off:



- Normal operation
- There is currently no active data link.



Displays on the receiver's display panel

Status information such as frequency, reception quality, battery status and audio level is shown on the display.

The display also shows the operating menu, which you can use to configure all of the settings (see [Buttons for navigating the menu](#)).

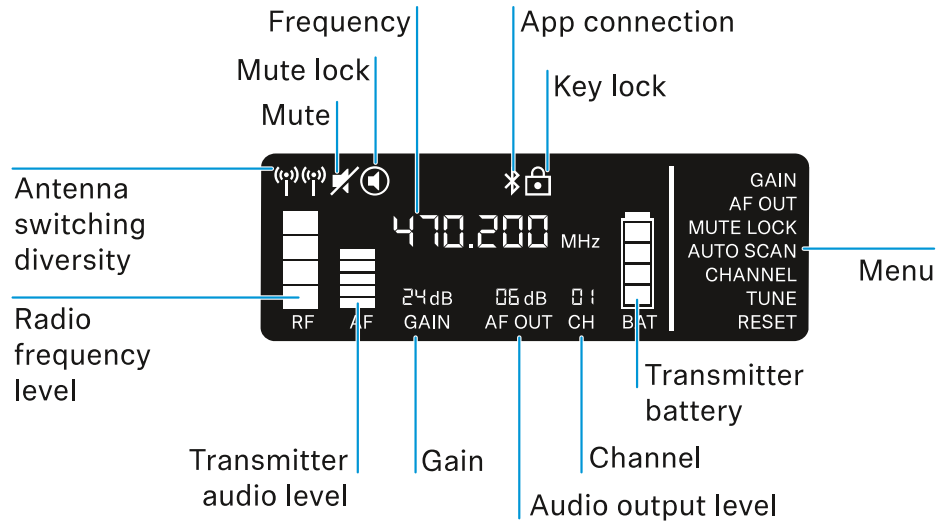

Further information

Antenna switching diversity / radio level:

- [Establishing a radio link | Synchronizing the receiver and transmitter](#)

Mute / mute lock:

- [MUTE LOCK menu item | Muting the handheld transmitter | Muting the bodypack transmitter](#)

Frequency:

- [AUTO SCAN menu item | CHANNEL menu item | TUNE menu item](#)

Connecting to the app:

- [Smart Assist app](#)

Lock-off function:

- [Lock-off function](#)



Menu:

- [Buttons for navigating the menu](#)

Transmitter battery

- [SKM-S: Inserting and removing the batteries/rechargeable batteries](#) | [SK: Inserting and removing the batteries/rechargeable batteries](#)

Channel:

- [CHANNEL menu item](#)

Audio output level:

- [AF OUT menu item](#)

Gain:

- [GAIN menu item](#)

Transmitter audio level:

- [GAIN menu item](#)



Buttons for navigating the menu

Use the following buttons to navigate through the receiver's operating menu.

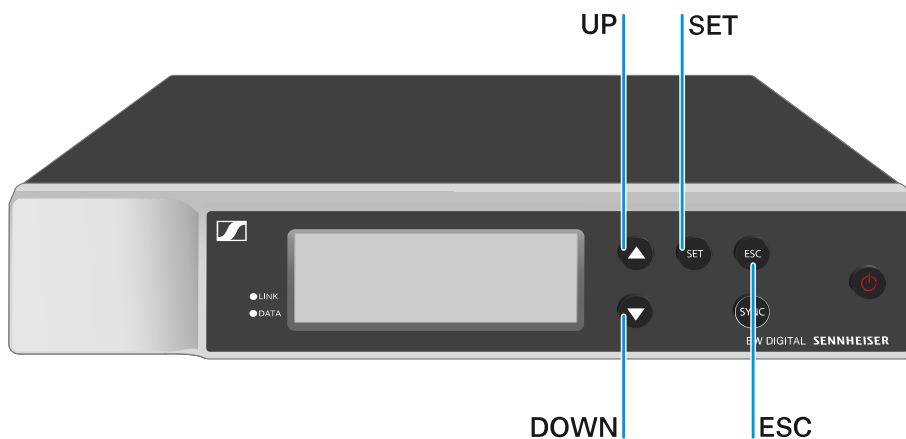

Press the **SET** button

- Open the menu
- Save settings in a menu item

Press the **UP** or **DOWN** button

- Changes to the previous or next menu item
- Changes the setting of a menu item

Press the **ESC** button

- Cancel input

i [Opening the menu and navigating the menu items](#)



Opening the menu and navigating the menu items

To open the menu:

- ▷ Press the **SET** button.
- ➔ The first menu item **GAIN** flashes.

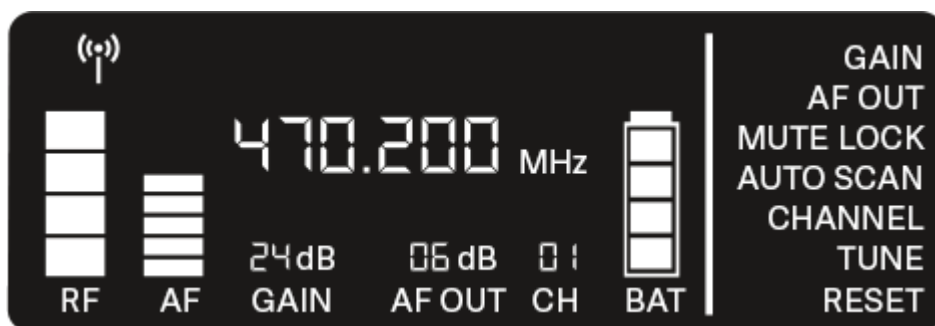

To navigate the menu items:

- ▷ Press the **UP** and **DOWN** buttons.
- ➔ The currently active menu item flashes.

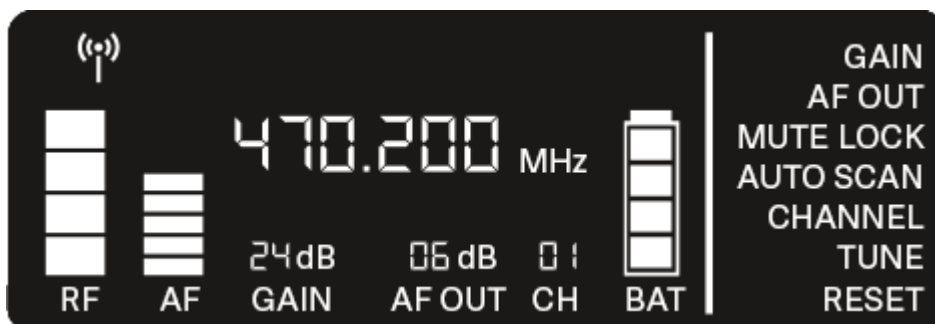

To open a menu item:

- ▷ Navigate to the desired menu item until it flashes.
- ▷ Press the **SET** button to open the selected menu item.

Related information

- [GAIN menu item](#)
- [AF OUT menu item](#)
- [MUTE LOCK menu item](#)
- [AUTO SCAN menu item](#)
- [CHANNEL menu item](#)
- [TUNE menu item](#)
- [RESET menu item](#)



GAIN menu item

Under the **GAIN** menu item, you can set the level of the audio signal coming from the coupled transmitter (e.g. vocals via EW-D SKM-S or guitar via EW-D SK).

- ▷ Open the **GAIN** menu item.
 - ➔ The item flashes on the display as follows.

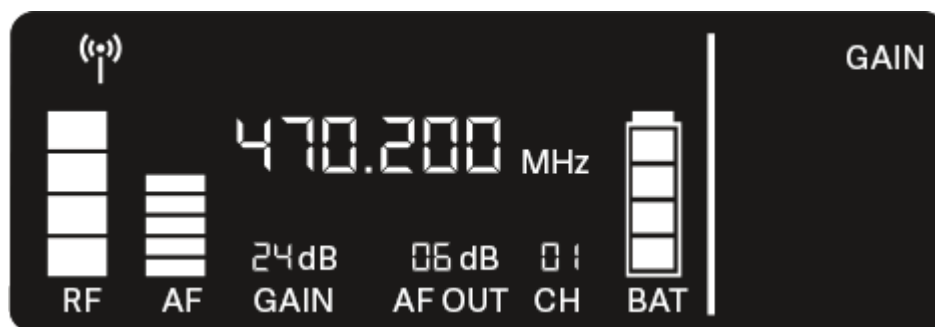

- ▷ Press the **UP** or **DOWN** button to adjust the value. Make sure that the level indicator **AF** on the display is not too high.
 - ➔ The **LINK** LED flashes yellow when the signal is overdriven.
- ▷ Press the **SET** button to save the set value.

i Recommended settings for a unity gain link:

Unity gain refers to the configuration where the audio signal arriving at a device leaves the device with the same level.

Example: If you are using an EW-D wireless link instead of a guitar cable, with **unity gain** settings, the volume of the guitar in the guitar amplifier will be as high as it would be if using a guitar cable.

Possible **unity gain** settings:

- AF Out **18 dB** | Gain **27 dB**
- AF Out **12 dB** | Gain **33 dB**
- AF Out **6 dB** | Gain **39 dB**



AF OUT menu item

Under the **AF OUT** menu item, you can set the level of the audio signal coming from the receiver's audio outputs (**AF out Bal/Unbal**). This audio signal can be output to a mixing console or an amplifier, for example.

- ▷ Open the **AF OUT** menu item.
 - ➔ The item flashes on the display as follows.

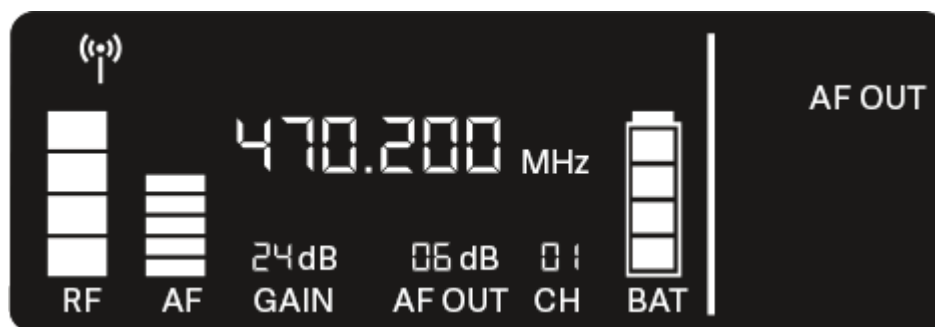

- ▷ Press the **UP** or **DOWN** button to adjust the value. Make sure that the signal in the next device in the signal chain (e.g. mixing console, power amplifier, guitar amplifier, etc.) is not overdriven.
- ▷ Press the **SET** button to save the set value.

i Recommended settings for a unity gain link:

Unity gain refers to the configuration where the audio signal arriving at a device leaves the device with the same level.

Example: If you are using an EW-D wireless link instead of a guitar cable, with **unity gain** settings, the volume of the guitar in the guitar amplifier will be as high as it would be if using a guitar cable.

Possible **unity gain** settings:

- AF Out **18 dB** | Gain **27 dB**
- AF Out **12 dB** | Gain **33 dB**
- AF Out **6 dB** | Gain **39 dB**



MUTE LOCK menu item

Under the **MUTE LOCK** menu item, you can disable the mute switch on the paired transmitter.

The transmitter can then no longer be muted.

- ▷ Open the **MUTE LOCK** menu item.
 - ➔ The item flashes on the display as follows.



- ▷ Press the **UP** or **DOWN** button to enable or disable the function.
 - ➔ If the following icon appears on the display, the transmitter's mute switch is disabled.

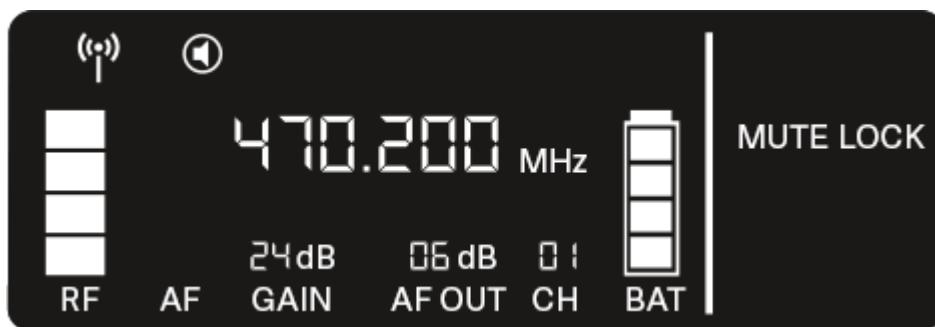

- ▷ Press the **SET** button to save the set value.



AUTO SCAN menu item

Under the **AUTO SCAN** menu item, you can perform an automatic frequency scan of your area. This enables you to easily find and assign free radio frequencies.

The scan starts at the lowest frequency in the device's frequency range.

- ▷ Open the **AUTO SCAN** menu item.
 - ➔ The scan starts automatically. The next free frequency is shown on the display.

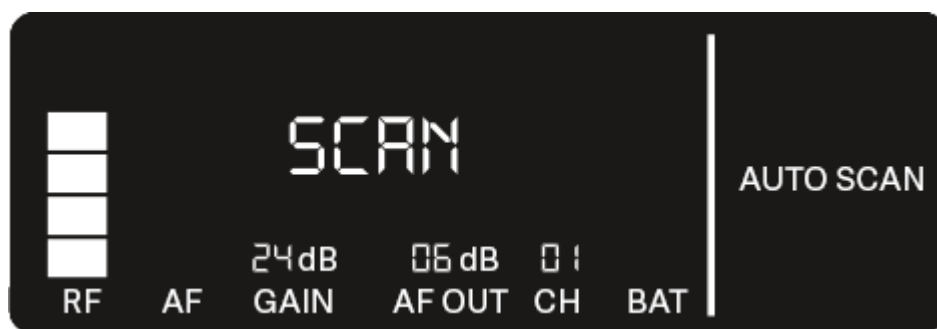

- ▷ Press the **SET** button to accept the displayed frequency.
 - Or
- ▷ Press the **UP** or **DOWN** button to display the next free frequency.
 - Or
- ▷ Press the **ESC** button to cancel the scan.
 - ➔ The previous frequency remains unchanged.

i If you have set a new frequency, you must still **synchronize the receiver with the transmitter** to establish the radio link (see [Establishing a radio link | Synchronizing the receiver and transmitter](#)).



CHANNEL menu item

Under the CHANNEL menu item, you can set the radio frequency by selecting a preset channel.

- i** If you are not sure whether the selected frequency is free, we recommend performing a scan to detect all free frequencies: [AUTO SCAN menu item](#).

- ▷ Open the **CHANNEL** menu item.
 - ➔ The item flashes on the display as follows.

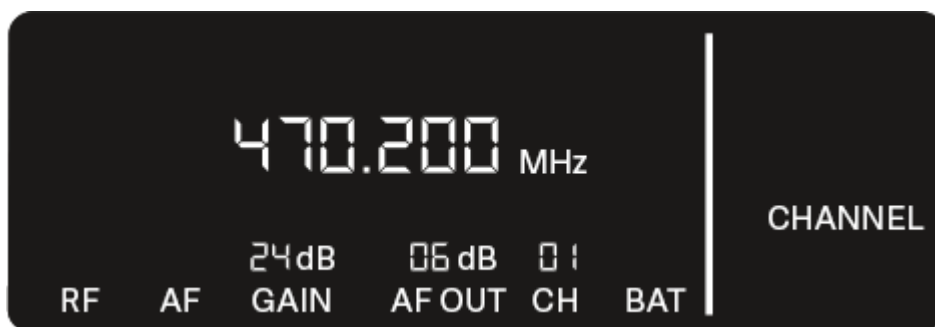

- ▷ Press the **UP** or **DOWN** button to select a preset channel.
- ▷ Press the **SET** button to accept the displayed frequency.
 - Or
- ▷ Press the **ESC** button to cancel the scan.
 - ➔ The previous frequency remains unchanged.

- i** If you have set a new frequency, you must still **synchronize the receiver with the transmitter** to establish the radio link (see [Establishing a radio link | Synchronizing the receiver and transmitter](#)).



TUNE menu item

Under the **TUNE** menu item, you can manually set the radio frequency independently of the preset channels.

- i** If you are not sure whether the selected frequency is free, we recommend performing a scan to detect all free frequencies: [AUTO SCAN menu item](#).

- ▷ Open the **TUNE** menu item.
 - ➔ The item flashes on the display as follows.



- ▷ Press the **UP** or **DOWN** button to set the frequency in the megahertz range.
- ▷ Press the **SET** button to save the set value.
 - ➔ The item flashes on the display as follows.

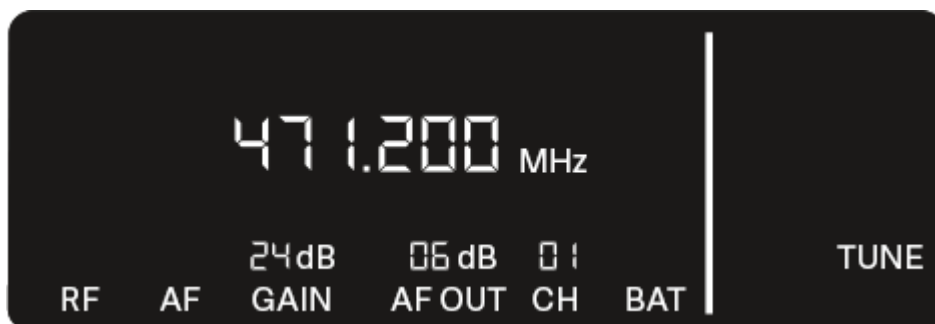

- ▷ Press the **UP** or **DOWN** buttons to finely adjust the frequency in the kilohertz range.
- ▷ Press the **SET** button to accept the displayed frequency.
 - Or
 - ▷ Press the **ESC** button to cancel the scan.
 - ➔ The previous frequency remains unchanged.

- i** If you have set a new frequency, you must still **synchronize the receiver with the transmitter** to establish the radio link (see [Establishing a radio link | Synchronizing the receiver and transmitter](#)).



RESET menu item

Under the **RESET** menu item, you can reset the receiver to its factory settings.

- ▷ Open the **RESET** menu item.
 - ➔ The item flashes on the display as follows.

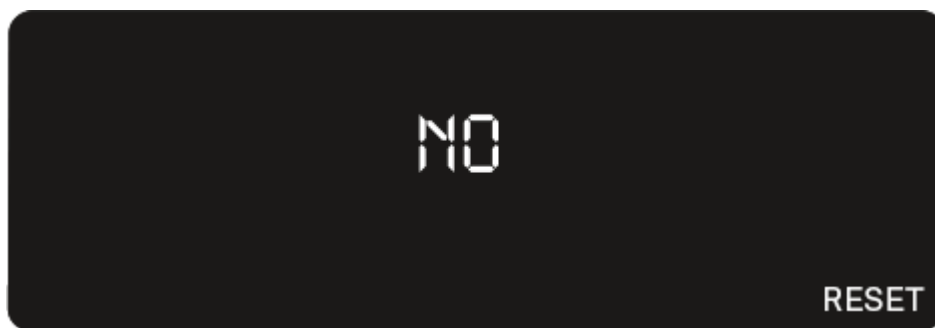

- ▷ Press the **UP** or **DOWN** button to switch between the options YES and NO.



- **YES:** The receiver is reset to its factory settings.
- **NO:** The receiver is not reset.
- ▷ Press the **SET** button to save the set value.



Using EW-D Color Coding Sets to label transmission paths

You can use the **EW-D Color Coding Sets** (see [Color Coding Sets](#)) to identify which transmitters belong to which receivers. This makes it easier to match up the individual devices, especially in multi-channel systems.

i You can also assign colors to the devices in the **Smart Assist** app.

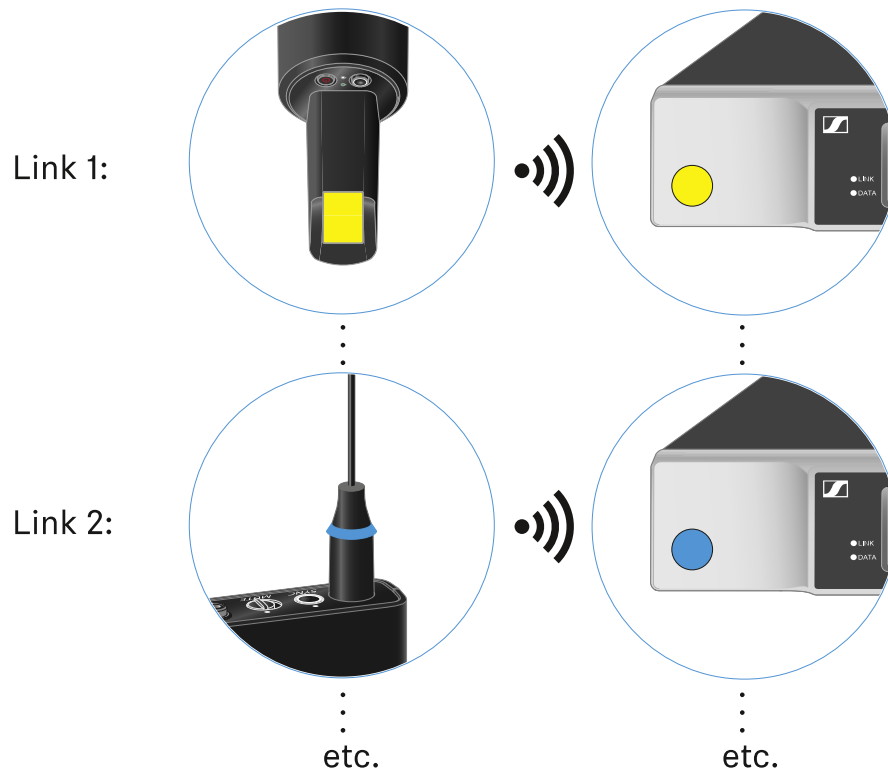



EW-D SKM-S handheld transmitter

Product overview

Inserting and removing the batteries/rechargeable batteries

Replacing the microphone module

Using EW-D Color Coding Sets to label transmission paths

Switching the handheld transmitter on and off

Checking the battery status of the transmitter (Check function)

Identifying the paired receiver (Identify function)

Meaning of the LEDs

Establishing a connection to the receiver

Muting the handheld transmitter

Product overview

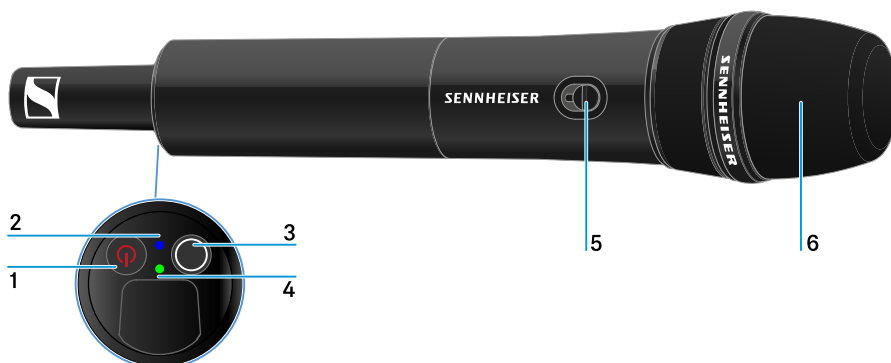

1 ON/OFF button

- See [Switching the handheld transmitter on and off](#)

2 DATA LED

- See [Meaning of the LEDs](#)

3 SYNC button

- See [Establishing a radio link | Synchronizing the receiver and transmitter](#)



4 LINK LED

- See [Meaning of the LEDs](#)

5 Mute switch

- See [Muting the handheld transmitter](#)

6 Microphone module

- See [Replacing the microphone module](#)



Inserting and removing the batteries/rechargeable batteries

You can operate the handheld transmitter either with batteries (AA, 1.5 V) or with the rechargeable Sennheiser BA 70 battery.



- ▷ Unscrew the microphone housing as shown in the figure and pull it down as far as it will go.
- ▷ Insert the batteries or the BA 70 rechargeable battery as indicated in the battery compartment. Observe correct polarity.
- ▷ Screw the microphone housing back on.



Note about the BA 70 rechargeable battery

- Make sure that the BA 70 rechargeable battery is inserted as follows:

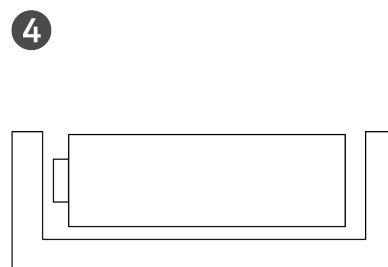
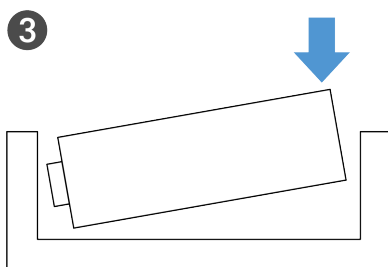
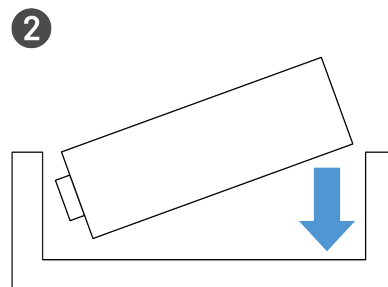
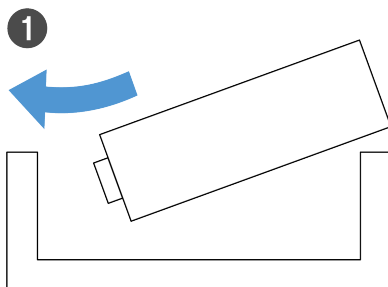



Replacing the microphone module

To replace the microphone module:

- ▷ Unscrew the microphone module.
- ▷ Screw the desired microphone module on.
- ▷ Do not touch the wireless microphone contacts or the microphone module contacts. If you touch the contacts, they may become dirty or bent.



Compatible microphone modules



The following microphone modules are compatible with the handheld transmitter:

- **MMD 835-1** | Dynamic microphone module with cardioid pattern
- **MMD 845-1** | Dynamic microphone module with super-cardioid pick-up pattern
- **MME 865-1** | Condenser microphone module with super-cardioid pick-up pattern
- **MMD 935-1** | Dynamic microphone module with cardioid pattern
- **MMD 945-1** | Dynamic microphone module with super-cardioid pick-up pattern
- **MMK 965-1** | Condenser microphone module with selectable pattern: cardioid and super-cardioid
- **MMD 42-1** | Dynamic microphone module with omni-directional pattern
- **Neumann KK 204** | Condenser microphone module with cardioid pattern
- **Neumann KK 205** | Condenser microphone module with super-cardioid pick-up pattern
- **MM 435** | Dynamic microphone module with cardioid pattern
- **MM 445** | Dynamic microphone module with super-cardioid pick-up pattern
- **ME 9002** | Condenser microphone module with omni-directional pattern
- **ME 9004** | Condenser microphone module with cardioid pattern
- **ME 9005** | Condenser microphone module with super-cardioid pick-up pattern



Using EW-D Color Coding Sets to label transmission paths

You can use the **EW-D Color Coding Sets** (see [Color Coding Sets](#)) to identify which transmitters belong to which receivers. This makes it easier to match up the individual devices, especially in multi-channel systems.

i You can also assign colors to the devices in the **Smart Assist** app.

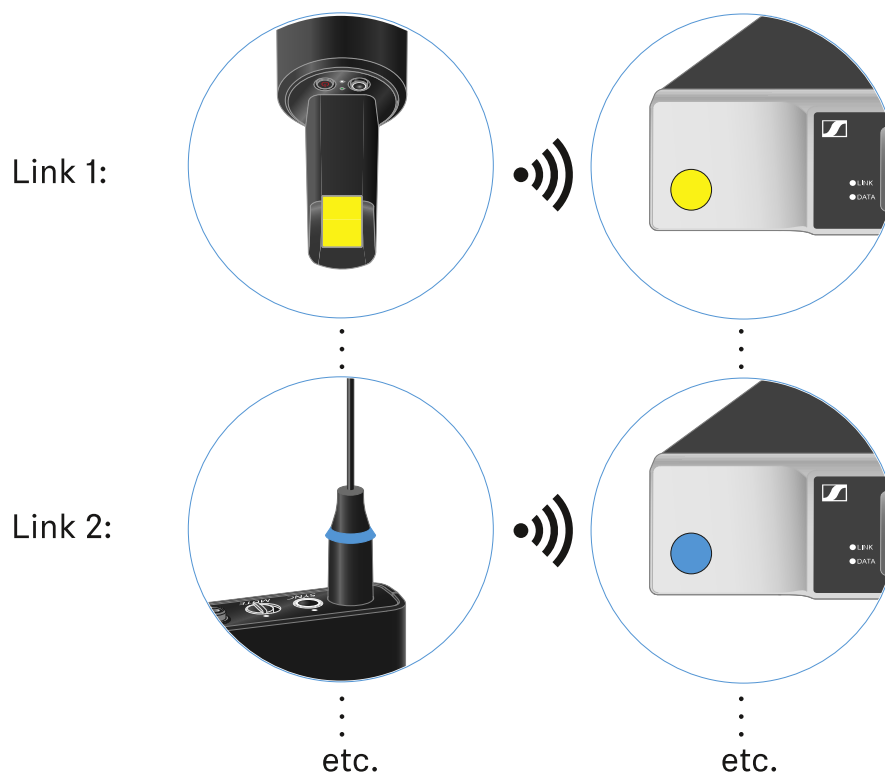



Switching the handheld transmitter on and off

To switch the handheld transmitter on:

- ▷ Short-press the **ON/OFF** button.
 - ➔ The **LINK** LED lights up and the transmitter switches on.

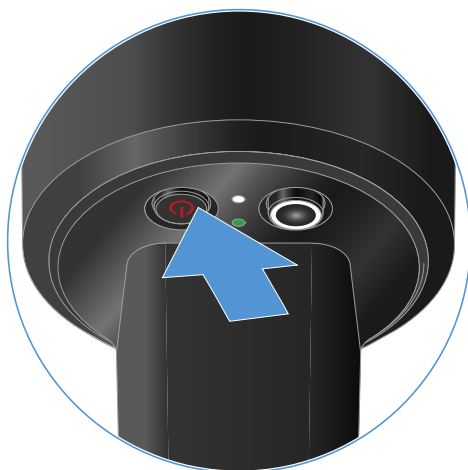

To switch the handheld transmitter off:

- ▷ Hold down the **ON/OFF** button until the LEDs switch off.





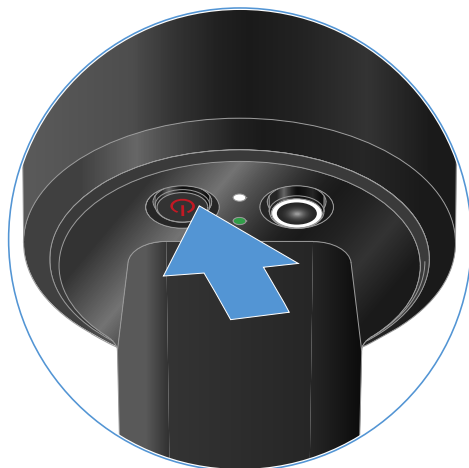

Checking the battery status of the transmitter (Check function)

To check the battery status of the transmitter:

- ▷ Short-press the **ON/OFF** button on the transmitter.



- ➔ The transmitter's **LINK LED** flashes to indicate the current charge level of the battery or the BA 70 rechargeable battery.

LINK LED	
	≤ 100 %
	≤ 60 %
	≤ 20 %

i Pressing the transmitter's **ON/OFF** button will simultaneously trigger the Identify function: [Identifying the paired receiver \(Identify function\)](#).



Identifying the paired receiver (Identify function)

In multi-channel systems, you can use the **Check** function to quickly identify to which receiver the transmitter is paired.

Both the transmitter and receiver must be switched on.

- ▷ Short-press the **ON/OFF** button on the transmitter.

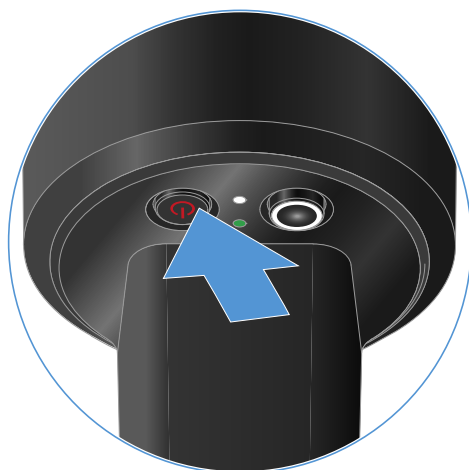

- ➔ The display on the paired receiver starts flashing.

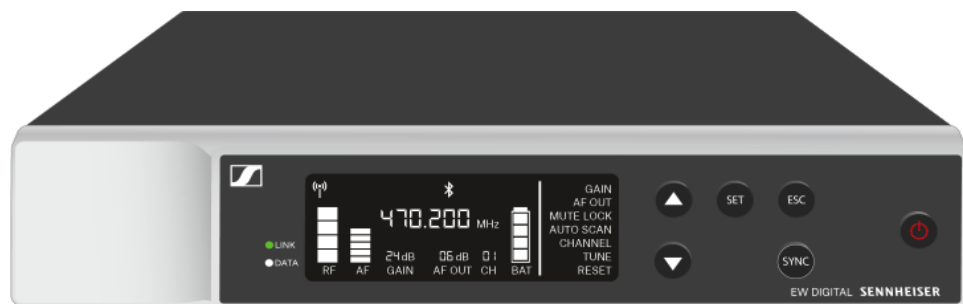

- i** Pressing the transmitter's **ON/OFF** button will simultaneously trigger the Check function: [Checking the battery status of the transmitter \(Check function\)](#).



Meaning of the LEDs

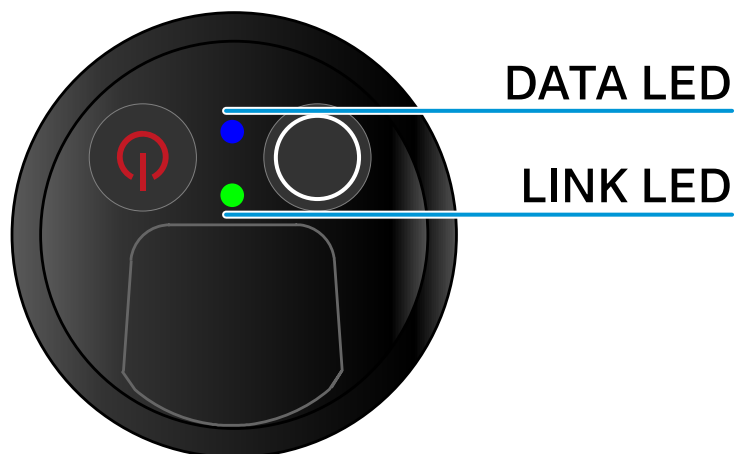

The **LINK** and **DATA** LEDs on the bottom of the transmitter can indicate the following information.

LINK LED

The **LINK** LED provides information about the status of the radio link between the transmitter and receiver, as well as status information for the paired transmitter.



The LED is green:



- The link between the transmitter and receiver is established.
- The transmission frequency is active.

The LED is yellow:



- The link between the transmitter and receiver is established.
- The audio signal is muted or
- No microphone module is mounted on the SKM-S handheld transmitter.

The LED is flashing yellow:



- The link between the transmitter and receiver is established.
- The audio signal is overdriven (clipping).

The LED is continuously red:



- The (rechargeable) battery in the transmitter is dead.

The LED is flashing red:



- The link between the transmitter and receiver is established.
- The battery/rechargeable battery in the transmitter is low.

The LED is off:



- No link between the transmitter and receiver.
- The transmitter is switched off.



DATA LED

The **DATA** LED provides information about the synchronization of transmitters and receivers.

The LED is flashing blue:



- The transmitter is being synchronized with a receiver.

The LED is blue:



- The firmware is being updated.

The LED is off:



- There is currently no active data link.



Establishing a connection to the receiver

To establish a radio link between the transmitter and the receiver, the devices must be synchronized.

See [Establishing a radio link | Synchronizing the receiver and transmitter](#)

i Conditions and restrictions for using frequencies

There may be special conditions and restrictions for using frequencies in your country.

Before putting the product into operation, find the information for your country at the following address:

[sennheiser.com/sifa](https://www.sennheiser.com/sifa)



Muting the handheld transmitter

You can mute the audio signal using the mute switch.

- ▷ Slide the mute switch to the desired position to mute or activate the audio signal.

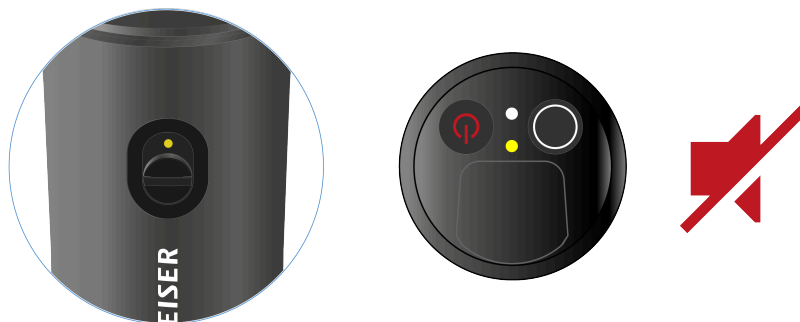

i You can disable the mute switch by activating the **MUTE LOCK** option on the receiver (see [MUTE LOCK menu item](#)).



EW-D SK bodypack transmitter

Product overview

- Inserting and removing the batteries/rechargeable batteries
- Connecting a microphone to the bodypack transmitter
- Connecting an instrument or line source to the bodypack transmitter
- Using EW-D Color Coding Sets to label transmission paths
- Changing the belt clip
- Switching the bodypack transmitter on and off
- Checking the battery status of the transmitter (Check function)
- Identifying the paired receiver (Identify function)
- Meaning of the LEDs
- Establishing a connection to the receiver
- Muting the bodypack transmitter

Product overview

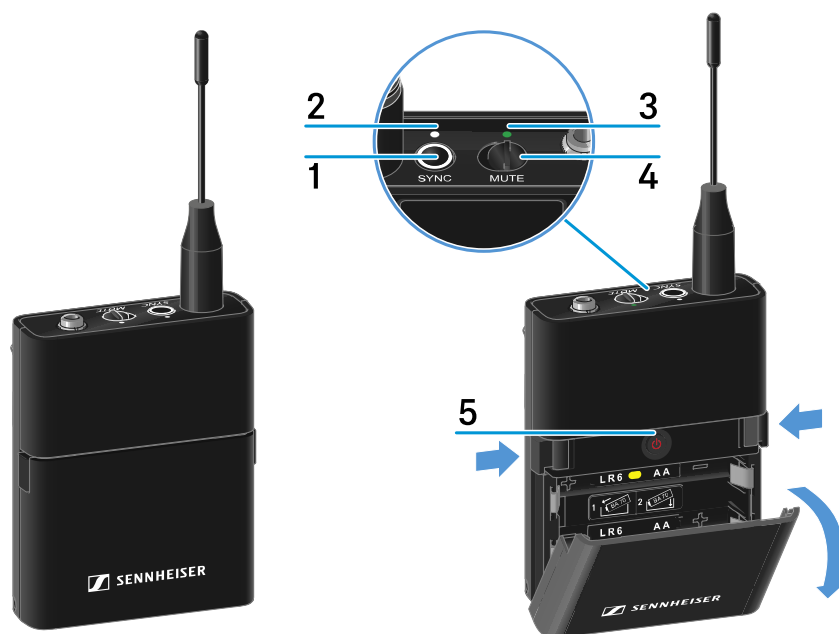

1 SYNC button

- See [Establishing a radio link | Synchronizing the receiver and transmitter](#)



2 DATA LED

- See [Meaning of the LEDs](#)

3 LINK LED

- See [Meaning of the LEDs](#)

4 Mute switch

- See [Muting the bodypack transmitter](#)

5 ON/OFF button

- See [Switching the bodypack transmitter on and off](#)



Inserting and removing the batteries/rechargeable batteries

You can operate the handheld transmitter either with batteries (AA, 1.5 V) or with the rechargeable Sennheiser BA 70 battery.

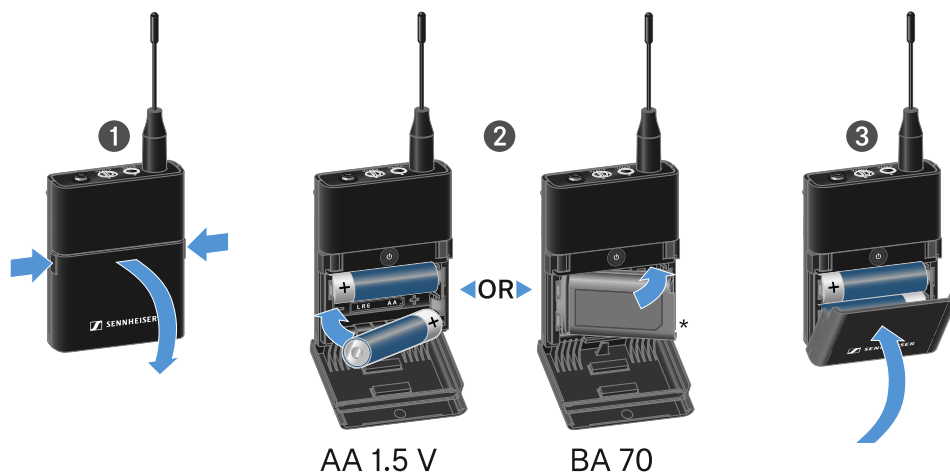

- ▷ Press the two catches and open the battery compartment cover.
- ▷ Insert the batteries or the BA 70 rechargeable battery as indicated in the battery compartment. Observe correct polarity.
- ▷ Close the battery compartment.
 - ➔ The cover locks into place with an audible click.



Note about the BA 70 rechargeable battery

- Make sure that the BA 70 rechargeable battery is inserted as follows:

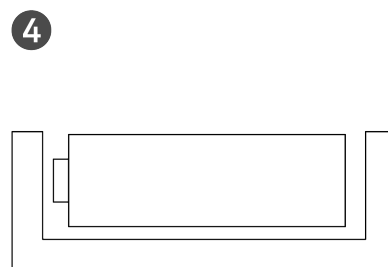
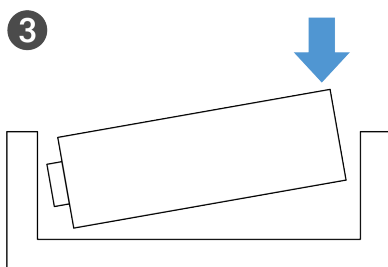
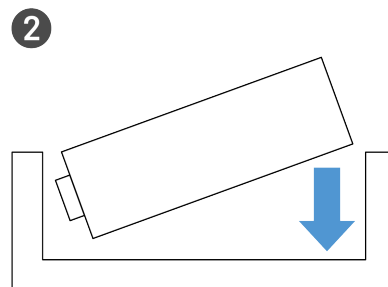
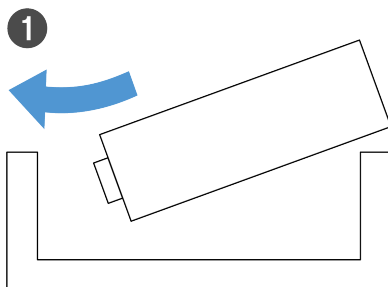



Connecting a microphone to the bodypack transmitter

To connect a microphone to the bodypack transmitter:

- ▷ Insert the cable's 3.5 mm jack plug into the socket on the bodypack transmitter as shown in the diagram.
- ▷ Screw the plug's coupling ring onto the audio socket thread of the bodypack transmitter.



Compatible microphones

The following microphones are compatible with the bodypack transmitter:



Lavalier microphones:

- **ME 2** | Lavalier microphone with omni-directional pattern (models from 2021 and later with gold-plated plug*)
- **ME 4** | Lavalier microphone with cardioid pattern (models from 2021 and later with gold-plated plug*)
- **MKE Essential Omni** | Lavalier microphone with omni-directional pattern
- **MKE 2 Gold** | Lavalier microphone with omni-directional pattern (models from 2018 and later with blue serial number label)
- **MKE 1** | Lavalier microphone with omni-directional pattern

Headset microphones:

- **ME 3** | Headset microphone with cardioid pattern (models from 2021 and later with gold-plated plug*)
- **HSP Essential Omni** | Headset microphone with omni-directional pattern
- **HSP 2** | Headset microphone with omni-directional pattern (models from March 2020 and later with code 1090 or higher)
- **HS 2** | Headset microphone with omni-directional pattern (models from 2021 and later with gold-plated plug*)
- **SL Headmic 1** | Headset microphone with omni-directional pattern

*Pre-2021 models with a nickel plug are not recommended. They can pick up noise if they are placed too close to the transmitter.



Connecting an instrument or line source to the bodypack transmitter

You can connect instruments or audio sources with a line level to the bodypack transmitter.

To do this, you will need the **CI 1** (6.3 mm jack plug on a lockable 3.5 mm jack plug) or **CL 2** (XLR-3F plug on a lockable 3.5 mm jack plug) Sennheiser cables.

To connect an instrument or line source to bodypack transmitter:

- ▷ Insert the cable's 3.5 mm jack plug into the socket on the bodypack transmitter as shown in the diagram.
- ▷ Screw the plug's coupling ring onto the audio socket thread of the bodypack transmitter.





Using EW-D Color Coding Sets to label transmission paths

You can use the **EW-D Color Coding Sets** (see [Color Coding Sets](#)) to identify which transmitters belong to which receivers. This makes it easier to match up the individual devices, especially in multi-channel systems.

i You can also assign colors to the devices in the **Smart Assist** app.

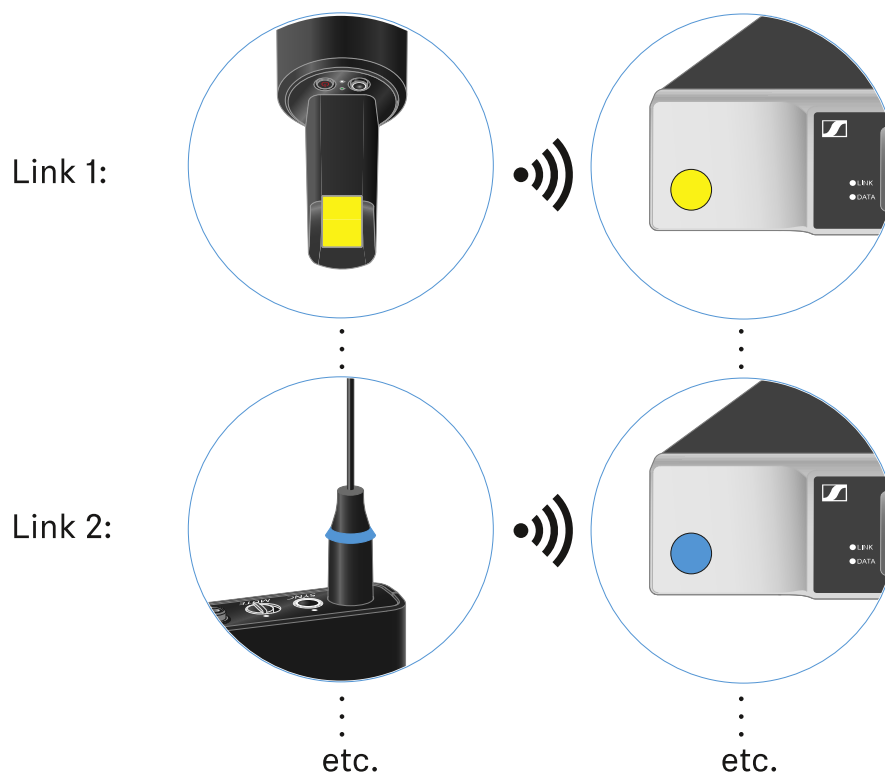



Changing the belt clip

You can change the belt clip on the bodypack transmitter or flip it over depending on how you want to wear it.

To remove the belt clip:

- ▷ Carefully loosen the belt clip with a small screwdriver as shown in the figure.
- ▷ Be very careful not to scratch the housing.

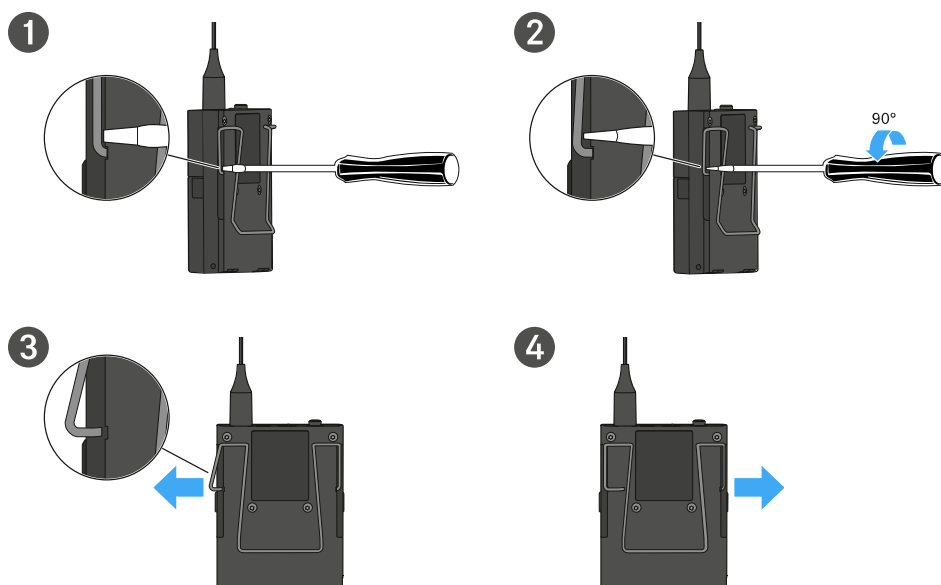

To insert the belt clip:

- ▷ Insert one side of the belt clip first as shown in the figure.
- ▷ Then insert the second side of the belt clip.
- ▷ Gently press the belt clip all the way in on both sides.
- ▷ Always insert one side before the other, not at the same time, as otherwise the belt clip could bend.

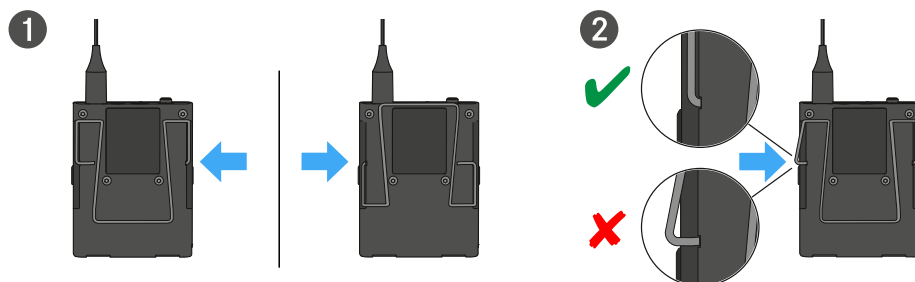



Switching the bodypack transmitter on and off

To switch the bodypack transmitter on:

- ▷ Short-press the **ON/OFF** button.
 - ➔ The **LINK** LED lights up and the transmitter switches on.

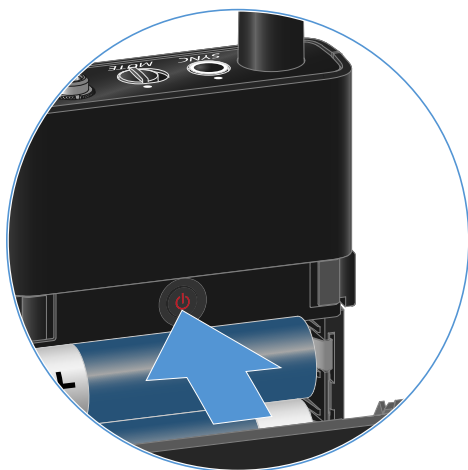

To switch the bodypack transmitter off:

- ▷ Hold down the **ON/OFF** button until the LEDs switch off.





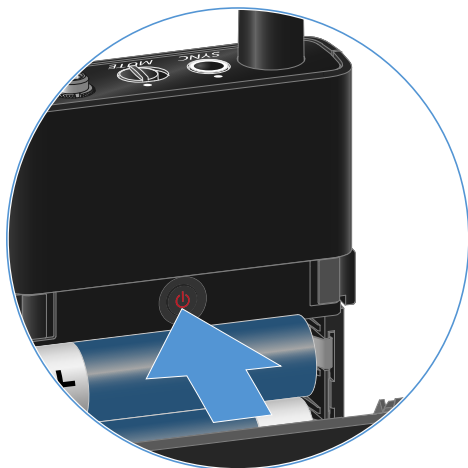

Checking the battery status of the transmitter (Check function)

To check the battery status of the transmitter:

- ▷ Short-press the **ON/OFF** button on the transmitter.



- ➔ The transmitter's **LINK LED** flashes to indicate the current charge level of the battery or the BA 70 rechargeable battery.

LINK LED	
	≤ 100 %
	≤ 60 %
	≤ 20 %

- i** Pressing the transmitter's **ON/OFF** button will simultaneously trigger the Identify function: [Identifying the paired receiver \(Identify function\)](#).



Identifying the paired receiver (Identify function)

In multi-channel systems, you can use the **Check** function to quickly identify to which receiver the transmitter is paired.

Both the transmitter and receiver must be switched on.

- ▷ Short-press the **ON/OFF** button on the transmitter.

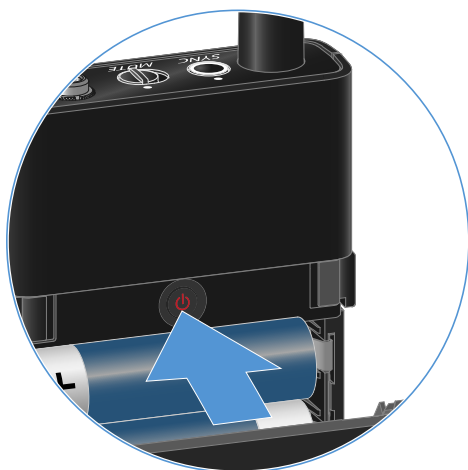

- ➔ The display on the paired receiver starts flashing.

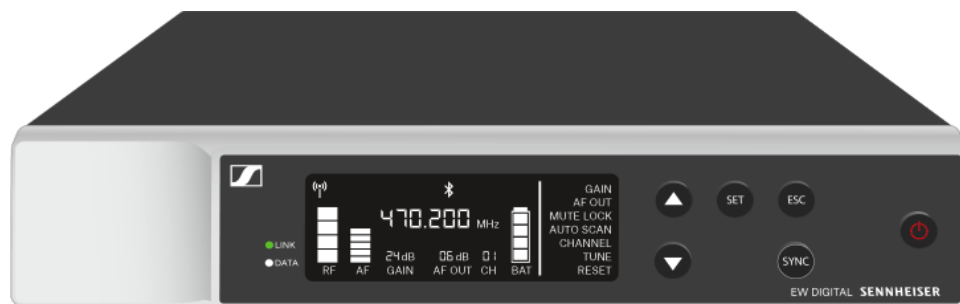

- i** Pressing the transmitter's **ON/OFF** button will simultaneously trigger the Check function: [Checking the battery status of the transmitter \(Check function\)](#).



Meaning of the LEDs

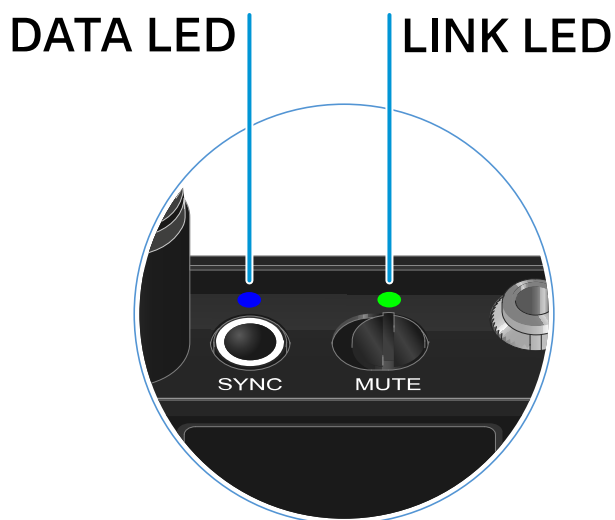

The **LINK** and **DATA** LEDs on the top of the transmitter can indicate the following information.

LINK LED

The **LINK** LED provides information about the status of the radio link between the transmitter and receiver, as well as status information for the paired transmitter.



The LED is green:



- The link between the transmitter and receiver is established.
- The transmission frequency is active.

The LED is yellow:



Or

- The link between the transmitter and receiver is established.
- The audio signal is muted.

- No microphone module is mounted on the SKM-S handheld transmitter.

The LED is flashing yellow:



- The link between the transmitter and receiver is established.
- The audio signal is overdriven (clipping).

The LED is continuously red:



- The (rechargeable) battery in the transmitter is dead.

The LED is flashing red:



- The link between the transmitter and receiver is established.
- The battery/rechargeable battery in the transmitter is low.

The LED is off:



- No link between the transmitter and receiver.
- The transmitter is switched off.



DATA LED

The **DATA** LED provides information about the synchronization of transmitters and receivers.

The LED is flashing blue:



- The transmitter is being synchronized with a receiver.
-

The LED is blue:



- The firmware is being updated.
-

The LED is off:



- There is currently no active data link.
-



Establishing a connection to the receiver

To establish a radio link between the transmitter and the receiver, the devices must be synchronized.

See [Establishing a radio link | Synchronizing the receiver and transmitter](#)

i Conditions and restrictions for using frequencies

There may be special conditions and restrictions for using frequencies in your country.

Before putting the product into operation, find the information for your country at the following address:

[sennheiser.com/sifa](https://www.sennheiser.com/sifa)



Muting the bodypack transmitter

You can mute the audio signal using the mute switch.

- ▷ Slide the mute switch to the desired position to mute or activate the audio signal.



- i** You can disable the mute switch by activating the **MUTE LOCK** option on the receiver (see [MUTE LOCK menu item](#)).



EW-DX EM 2 rack receiver

- Product overview
- Connecting/disconnecting the receiver to/from the power supply system
- Connecting receivers in a network
- Connecting antennas
- Outputting audio signals
- Installing receivers in a rack
- Switching the receiver on and off
- Lock-off function
- Using the headphone output
- Meaning of the LEDs
- Displays on the receiver's display panel
- Home screens 2 and 3
- Channel 1
- Channel 2
- Meaning of the Link Quality Indicator
- Buttons for navigating the menu
- Opening the menu and navigating the menu items
- Menu structure
- Setting options in the menu
- Ch 1 / Ch 2 -> Name menu item
- Ch 1 / Ch 2 -> Frequency menu item
- Ch 1 / Ch 2 -> Gain menu item
- Ch 1 / Ch 2 -> AF Out menu item
- Ch 1 / Ch 2 -> Trim menu item
- Ch 1 / Ch 2 -> Low Cut menu item
- Ch 1 / Ch 2 -> Cable Emul. menu item
- Ch 1 / Ch 2 -> Mute Mode menu item
- Ch 1 / Ch 2 -> Auto Lock menu item
- Ch 1 / Ch 2 -> LED menu item
- Ch 1 / Ch 2 -> Sync Parameters menu item
- Ch 1 / Ch 2 -> Scan / Auto Setup menu item
- Ch 1 / Ch 2 -> TX Software menu item
- System menu item
- System -> Encryption menu item
- System -> Link Density menu item
- System -> Network menu item
- System -> TX Update menu item
- System -> Auto Setup menu item
- System -> This Device menu item
- Updating the firmware of the receiver



Product overview

Front

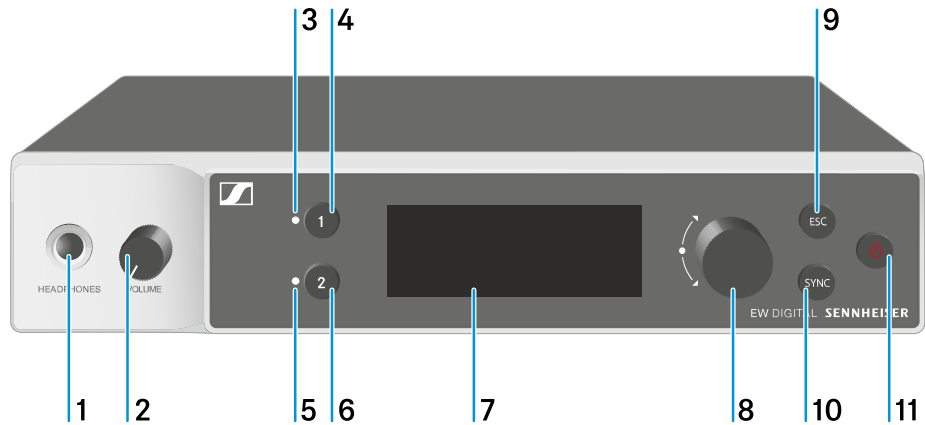

- 1 Headphone socket
 - See [Using the headphone output](#)
- 2 Volume control for the headphone socket
 - See [Using the headphone output](#)
- 3 **CH 1** LED to indicate the status of channel 1
 - See [Meaning of the LEDs](#)
- 4 **CH 1** button for selecting channel 1
 - See [Displays on the receiver's display panel](#)
 - See [Buttons for navigating the menu](#)
- 5 **CH 2** LED to indicate the status of channel 2
 - See [Meaning of the LEDs](#)
- 6 **CH 2** button for selecting channel 2
 - See [Displays on the receiver's display panel](#)
 - See [Buttons for navigating the menu](#)



- 7 Display for status information and operating menu
 - See [Displays on the receiver's display panel](#)
- 8 Jog dial (**UP/DOWN/SET**) for navigating the operating menu
 - See [Buttons for navigating the menu](#)
- 9 **ESC** button for canceling an action in the menu
 - See [Buttons for navigating the menu](#)
- 10 **SYNC** button for synchronizing the transmitter and receiver
 - See [Establishing a radio link | Synchronizing the receiver and transmitter](#)
- 11 **ON/OFF** button for switching the device on and off
 - See [Switching the receiver on and off](#)

Back

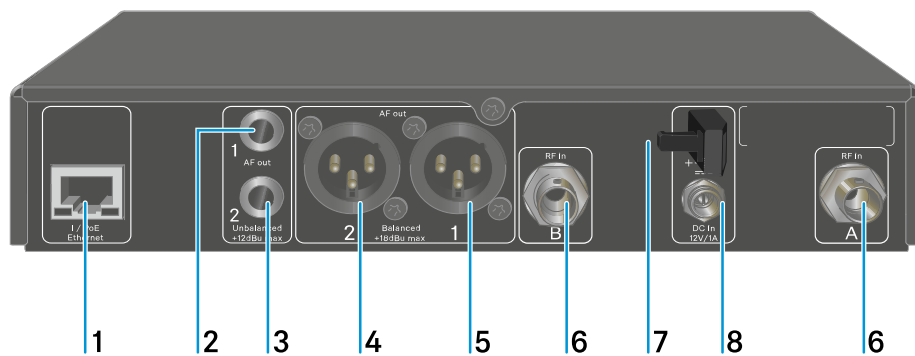

- 1 **PoE/Ethernet** RJ-45 socket for controlling the device over the network and for Power over Ethernet power supply
 - See [Connecting receivers in a network](#)
 - See [Connecting/disconnecting the receiver to/from the power supply system](#)



- 2 6.3 mm jack socket for **AF out Unbalanced** audio output for channel 1
 - See [Outputting audio signals](#)
- 3 6.3 mm jack socket for **AF out Unbalanced** audio output for channel 2
 - See [Outputting audio signals](#)
- 4 XLR-3 socket for **AF out Balanced** audio output for channel 2
 - See [Outputting audio signals](#)
- 5 XLR-3 socket for **AF out Balanced** audio output for channel 1
 - See [Outputting audio signals](#)
- 6 BNC sockets **ANT 1 RF in** and **ANT 2 RF in** for antenna inputs
 - See [Connecting antennas](#)
- 7 Strain relief for the connection cable of the power supply unit
 - See [Connecting/disconnecting the receiver to/from the power supply system](#)
- 8 **DC in** connection socket for the power supply unit
 - See [Connecting/disconnecting the receiver to/from the power supply system](#)



Connecting/disconnecting the receiver to/from the power supply system

You can operate the receiver using either the included power supply unit or with Power over Ethernet (PoE IEEE 802.3af Class 0). Please refer to the following information.

Power from the power supply unit

- i** If using a power supply unit, use only the power supply unit included with the device. It is designed for your receiver and ensures safe operation.

- i** You will find the power supply unit and the country adapters in the packaging under the tray:

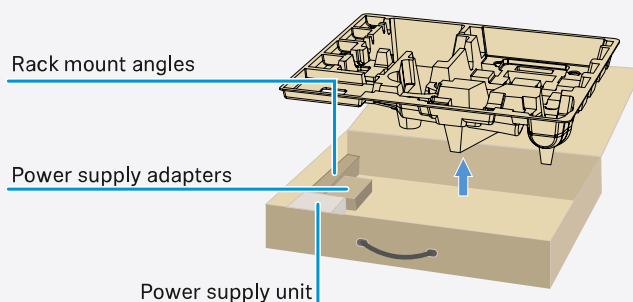

To connect the receiver to the power supply system:

- ▷ Insert the plug of the power supply unit into the **DC in** socket on the receiver.
- ▷ Pass the cable of the power supply unit through the strain relief.



- ▷ Slide the supplied country adapter onto the power supply unit.
- ▷ Plug the power supply unit into the wall socket.

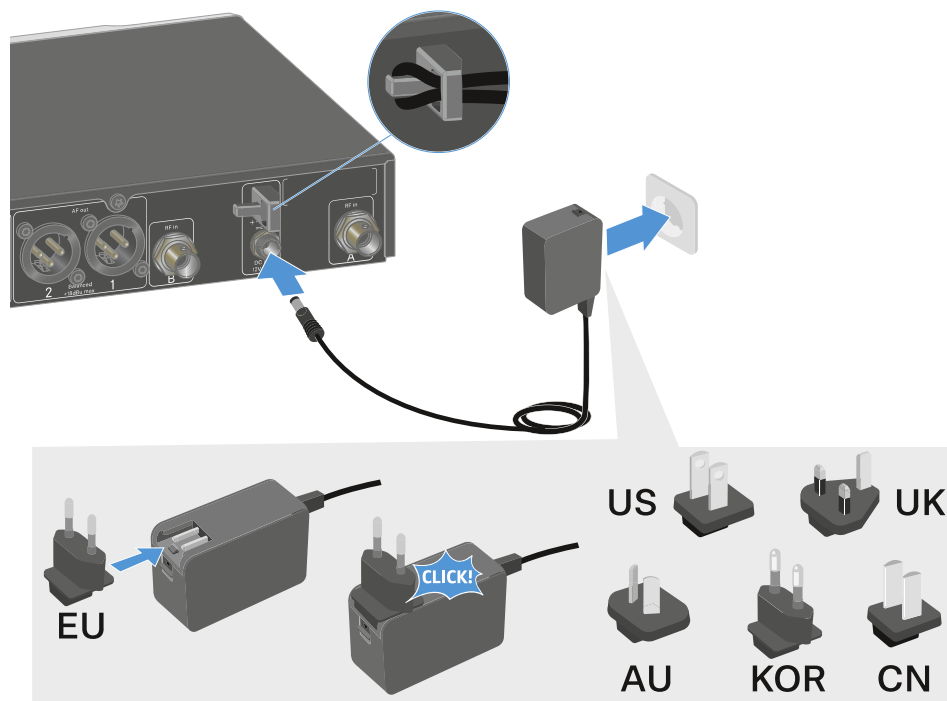

To completely disconnect the receiver from the power supply system:

- ▷ Unplug the power supply unit from the wall socket.
- ▷ Unplug the power supply unit from the **DC in** socket on the receiver.



Power over Ethernet (PoE)

i The receiver can be powered via **Power over Ethernet** (PoE IEEE 802.3af Class 0).

▷ Connect the receiver to a **PoE**-enabled network switch.

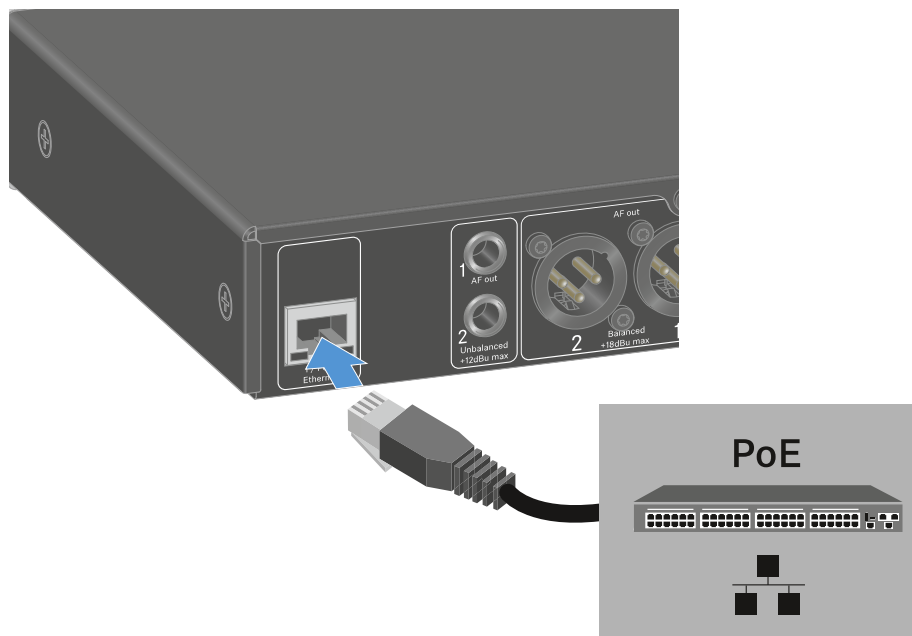



Connecting receivers in a network

You can monitor and control one or more receivers via a network connection using the **Sennheiser Wireless Systems Manager (WSM)** or **Sennheiser Control Cockpit (SCC)** software.

- i** The network does not have to be a homogeneous network including only receivers. You can integrate the receiver into your existing network infrastructure with any other types of devices.

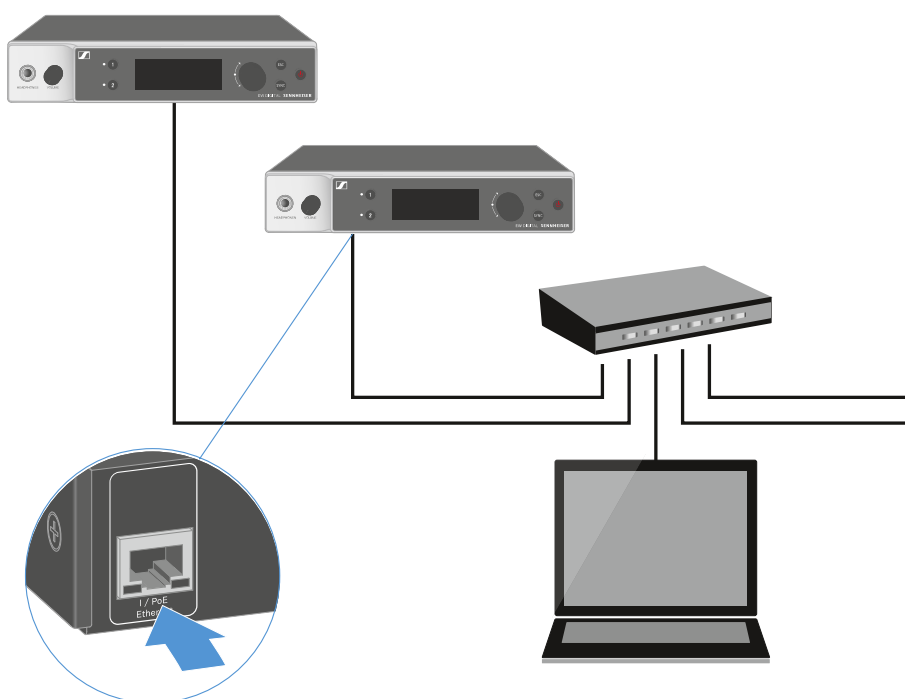

- i** For more information about controlling devices via the Sennheiser Wireless Systems Manager or Sennheiser Control Cockpit software, refer to the instruction manual for the software. You can download the software here:

sennheiser.com/wsm

sennheiser.com/control-cockpit-software



Connecting antennas

To connect the supplied rod antennas:

- ▷ Connect the antennas to the two antenna inputs on the receiver as shown in the figure.
- ▷ Slightly angle the antennas to the left and right as shown in the figure.

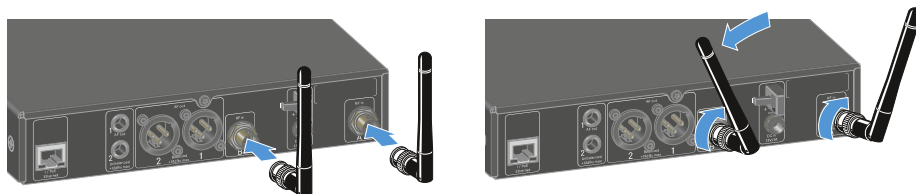

i If you are using more than one receiver, we recommend using remote antennas and possibly the [EW-D ASA antenna splitter](#) ([EW-D ASA antenna splitter](#)).

To connect remote antennas:

- ▷ Connect the antennas to the two antenna inputs on the receiver as shown in the figure.

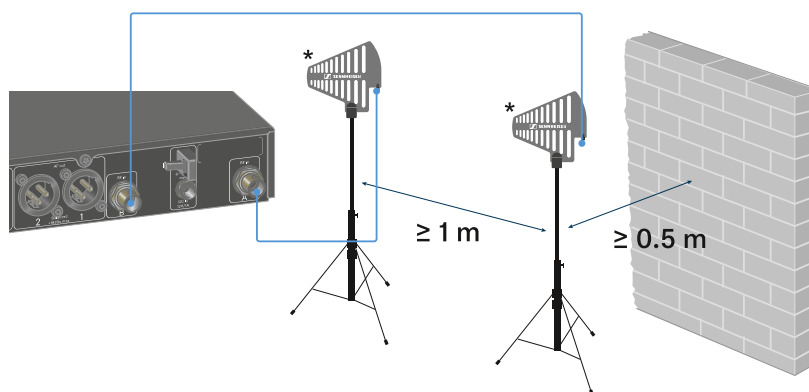

- ▷ Observe the specified minimum spacing.



▷ Observe the specified minimum spacing to the transmitters.

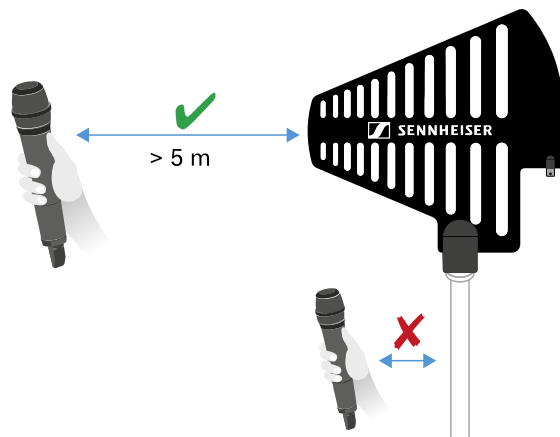

***Recommended antennas:**

- **ADP UHF** | 470 – 1075 MHz
- **AD 1800** | 1400 – 2400 MHz

i If you are using more than one receiver, we recommend using remote antennas and possibly the [EW-D ASA antenna splitter](#) ([EW-D ASA antenna splitter](#)).



Outputting audio signals

Each of the two channels on the EW-DX EM 2 has both a balanced XLR-3M output socket and an unbalanced 6.3 mm (1/4") jack output socket.

- ▷ Always use only one of the two output sockets for each channel.

To connect an XLR cable:

- ▷ Plug the XLR cable into the **AF out Balanced** socket for the respective channel on the EW-DX EM 2.

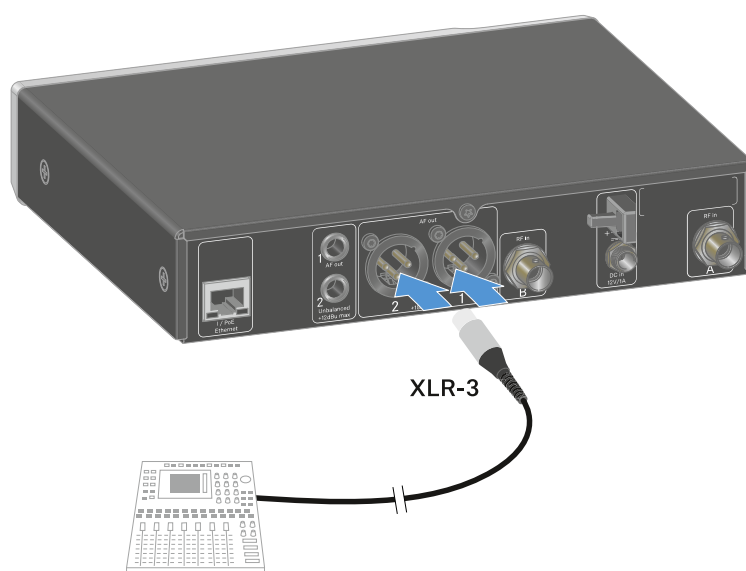



To connect a jack cable:

- ▷ Plug the jack cable into the **AF out Unbalanced** socket for the respective channel on the EW-DX EM 2.

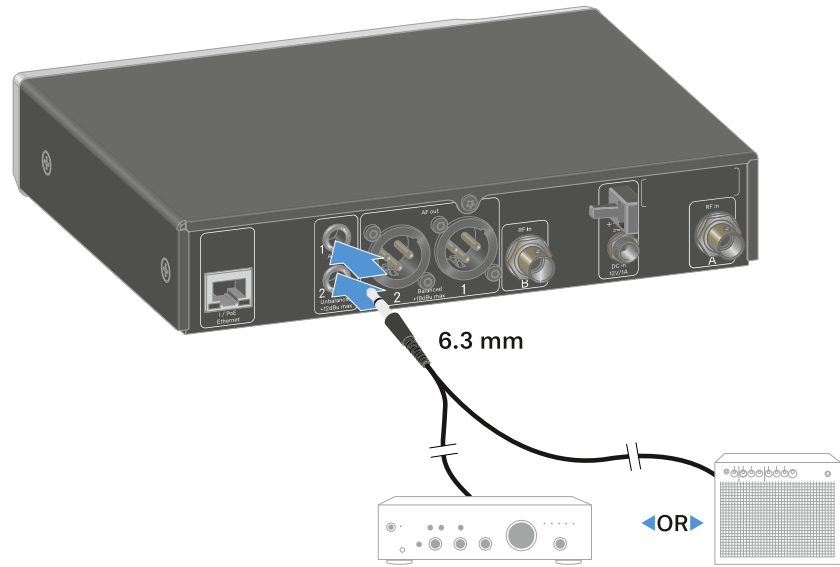



Installing receivers in a rack

Observe the following instructions when mounting the receiver in a rack.

- i** The mounting brackets for installing the receiver in the rack can be found in the packaging under the tray:

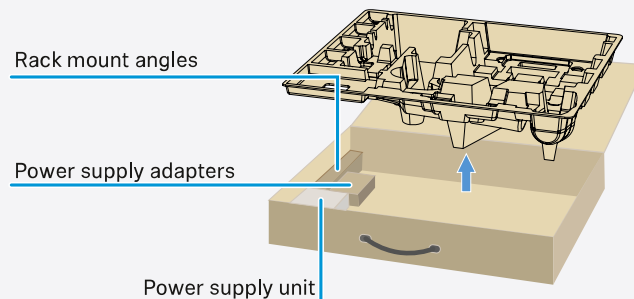

NOTICE



Rack mounting poses risks!

When installing the device in a closed 19" rack or multi-rack assembly, please consider that, during operation, the ambient temperature, the mechanical load and the electrical potentials will be different from those of devices which are not mounted into a rack.

- ▷ Make sure that the ambient temperature within the rack does not exceed the permissible temperature limit stated in the specifications. See [Specifications](#).
- ▷ Ensure sufficient ventilation; if necessary, provide additional ventilation.
- ▷ Make sure that the mechanical load of the rack is even.
- ▷ When connecting to the power supply system, observe the information indicated on the type plate. Avoid overloading the circuits. If necessary, provide overcurrent protection.
- ▷ When mounting in a rack, please note that intrinsically harmless leakage currents of the individual power supply units may accumulate, thereby exceeding the permissible limit value. As a remedy, ground the rack via an additional ground connection.



Mounting a single receiver in a rack

- ▷ Connect the mounting brackets to the sides of the receiver as shown.

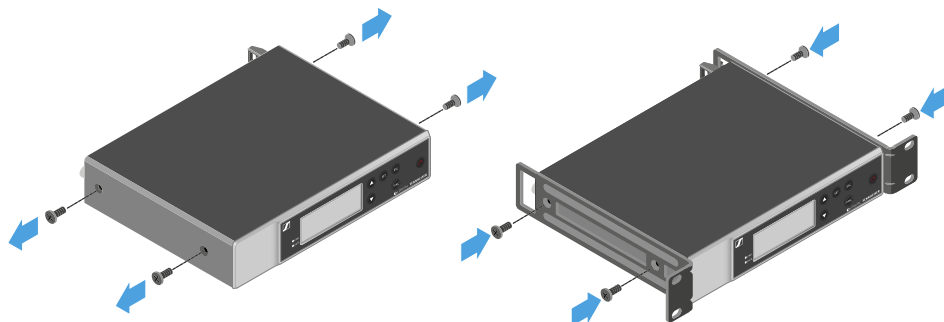

- ▷ Attach the front panel as shown.
- ▷ If desired, attach the antennas to the front panel as shown. This requires the optional AM 2 antenna front mount kit (see [Accessories for rack mounting](#)).

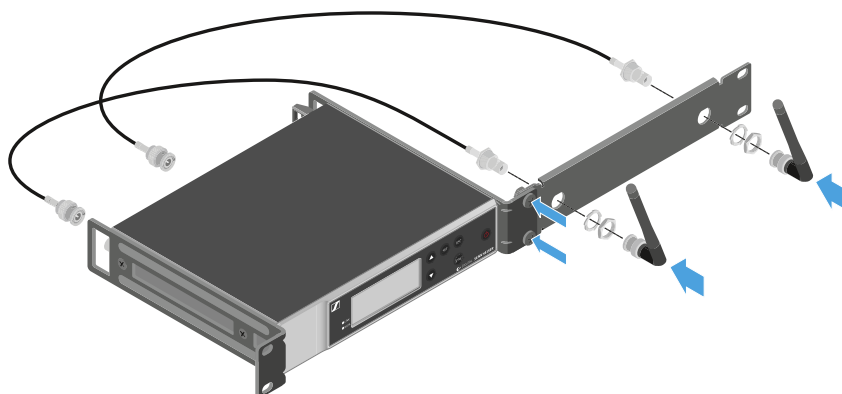



Mounting two receivers side by side in a rack

- ▷ Place both receivers upside down and side by side on an even surface.
- ▷ Tighten the jointing plate as shown.
- ▷ Attach the mounting brackets as shown.

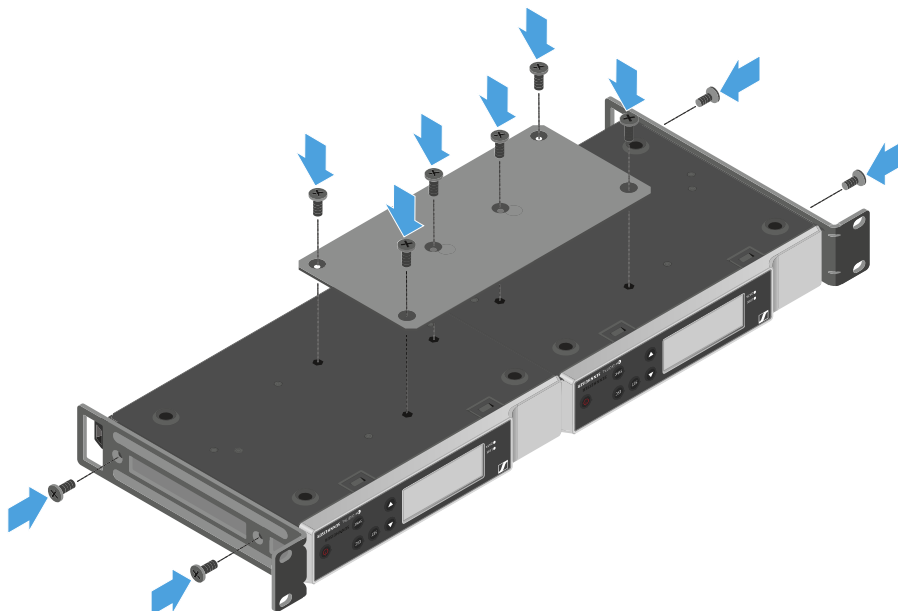



Switching the receiver on and off

To switch the receiver on:

- ▷ Short-press the **ON/OFF** button.
 - ➡ The receiver switches on.

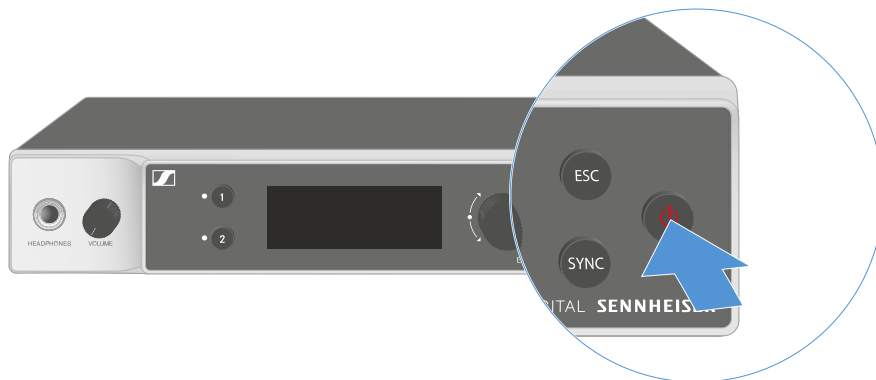

To switch the receiver to standby mode:

- ▷ If necessary, deactivate the lock-off function (see [Lock-off function](#)).
- ▷ Hold down the **ON/OFF** button until the display switches off.

To switch the receiver off completely:

- ▷ Disconnect the receiver from the power supply system by unplugging the power supply unit from the wall socket or disconnecting the PoE connection.



Lock-off function

You can enable or disable the automatic lock-off function in the **This Device** -> **Device Lock** menu item (see [System](#) -> [This Device menu item](#)).

To temporarily deactivate the lock-off function:

- ▷ Press the **jog dial**.
 - ➔ **Locked** appears in the display panel.
- ▷ Turn the **jog dial**.
 - ➔ **Unlock?** appears in the display panel.
- ▷ Press the **jog dial**.
 - ➔ Lock-off function is now temporarily deactivated.

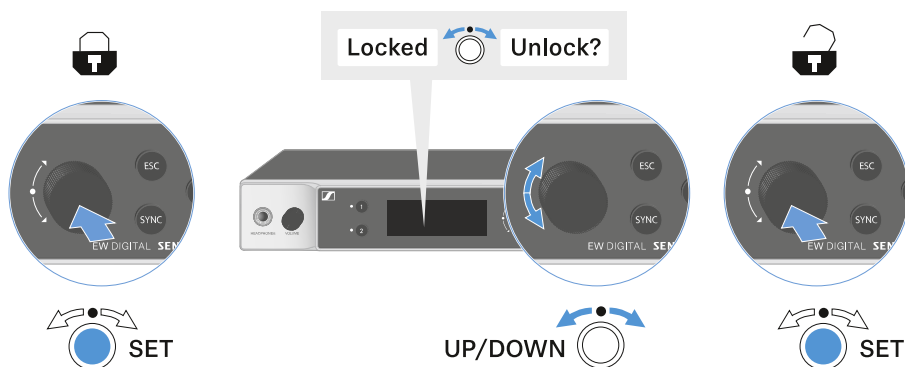

- ✓ The lock-off function remains deactivated while you are actively working in the operating menu.

i After 10 seconds of inactivity, it automatically activates again.



Using the headphone output

You can use the headphone output on the front of the receiver (6.3 mm jack) to listen to the audio signals of the two channels.

⚠ CAUTION



Danger due to high volume levels

Volume levels that are too high may damage your hearing.

- ▷ Turn down the volume of the headphone output before you put on the headphone.

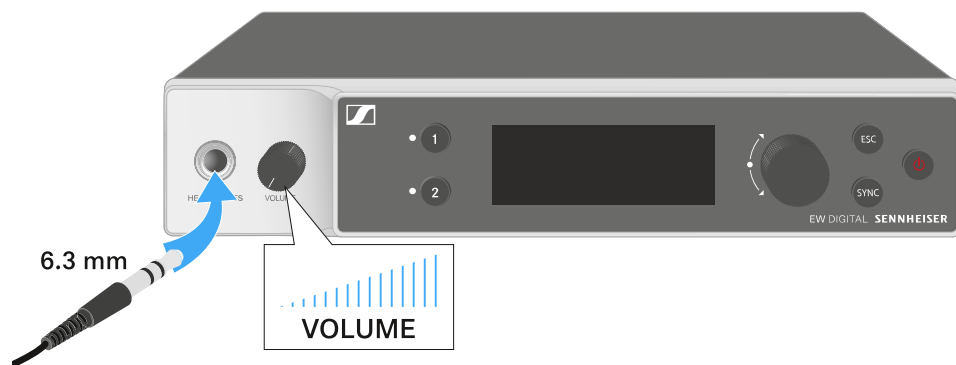

- ▷ Connect the headphone to the headphone output.
- ▷ Press the **CH 1** or **CH 2** button to listen to the audio signal from channel 1 or channel 2.
 - ➔ The headphone icon on the display indicates which channel is currently active on the headphone output. By default, the signal from channel 1 is active on the headphone output.
- ▷ You can control the volume by turning the volume knob next to the headphone output.



Meaning of the LEDs

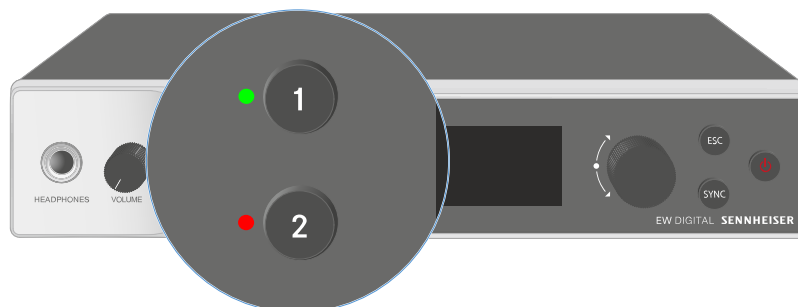

The two LEDs on the front of the receiver indicate the following information for channel 1 and channel 2.

The LED is green:



- The link between the transmitter and receiving channel is established.
- The audio signal is active.

The LED is yellow:



- The link between the transmitter and receiving channel is established.
- The audio signal is muted.



or

- No microphone module is mounted on the handheld transmitter.

The LED is flashing yellow:



- The link between the transmitter and receiving channel is established.
- The audio signal is overdriven (clipping).

The LED is continuously red:



- The link between the transmitter and receiving channel is established.
- The audio signal is overdriven (clipping).

The LED is flashing red:



- The link between the transmitter and receiving channel is established.
- The battery/rechargeable battery in the paired transmitter is low.

The LED is flashing blue:



- The **Bluetooth Low Energy** link is being established between the receiver and a smartphone or tablet with the **Smart Assist** app.

or

- The receiving channel is being synchronized with a transmitter.

The LED is blue:



- The firmware is being updated.
-



Displays on the receiver's display panel

Status information such as frequency, reception quality, battery status and audio level is shown on the display.

The display also shows the operating menu, which you can use to configure all of the settings (see [Buttons for navigating the menu](#)).

Home screen

The home screen is the default view on the display. The following information for both receiving channels is displayed here.

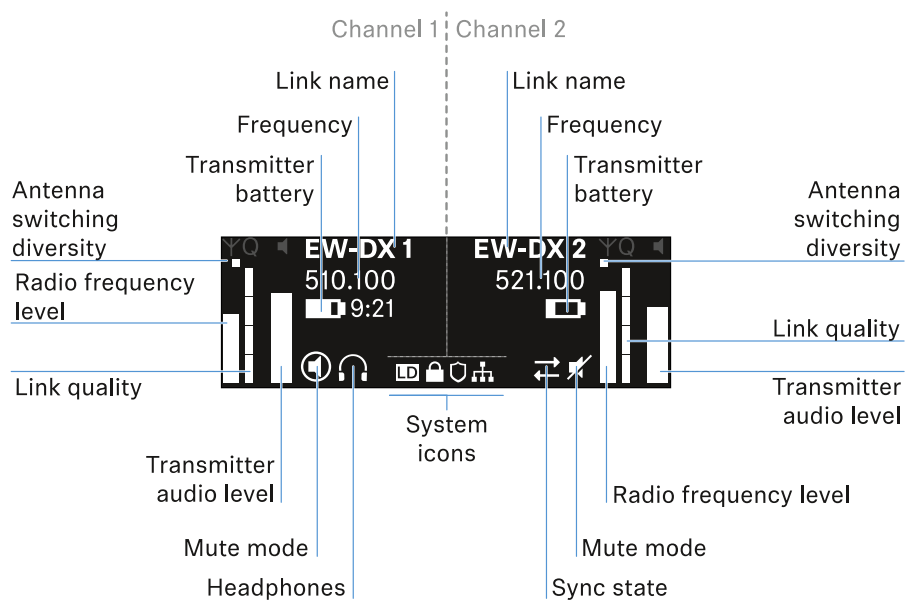

Antenna switching diversity:

Indicates which of the two antennas is currently active (left or right).

Signal level:

Displays the RF signal strength for the respective channel.

Link quality:

Displays the transmission quality for the respective channel.



i On the one hand, the transmission quality depends on the field strength (RF level indicator on the display). However, on the other hand, it also depends on external sources of interference that cannot be identified on the RF level indicator (for example, they may be on the same frequency or a very close neighboring frequency or may not affect the field strength).

As a basic principle, a value significantly higher than 50% should be achieved for a secure transmission.

Link name:

You can assign a name to the radio link in the receiver menu (see [Ch 1 / Ch 2 -> Name menu item](#)).

Frequency:

You can set the frequency of the radio link manually or using the Auto-Setup function.

- See [Ch 1 / Ch 2 -> Frequency menu item](#)
- See [Ch 1 / Ch 2 -> Scan / Auto Setup menu item](#)

Transmitter audio level:

Displays the audio input level for the respective channel (see [Ch 1 / Ch 2 -> Gain menu item](#)).

This level is separate from the audio level that is output from the receiver (see [Ch 1 / Ch 2 -> AF Out menu item](#)).

Transmitter battery:

Indicates the charging status of the transmitter's BA 70 rechargeable battery or batteries.

When using the BA 70 rechargeable battery, the remaining runtime is also displayed in hours and minutes.

Mute mode:



The mute switch is deactivated on the received transmitter.



The mute switch on the received transmitter is set to **AF Mute** and the audio signal is muted.

- [EW-DX SKM-S: Configuring mute mode and muting the handheld transmitter \(EW-DX SKM-S only\)](#)
- [EW-DX SK: Configuring mute mode and muting the bodypack transmitter](#)

Headphones:



The headphones icon indicates which channel is currently active on the headphone output (see [Using the headphone output](#)).

Sync state:



This icon indicates that different values are set for the receiving channel of the receiver and the transmitter. These values can be synchronized (see [Connecting to the EW-DX EM receivers / synchronizing the EW-DX EM](#)).

System icons:



The LD icon is displayed when Link Density mode is activated. See [System -> Link Density menu item](#).



The lock icon is displayed when the Auto Lock function is enabled. See [Lock-off function](#).



The network icon appears when a network connection is successfully established. See [Connecting receivers in a network](#).



The shield icon is displayed when AES 256 encryption is enabled. See [System -> Encryption menu item](#).

Related information

[Home screens 2 and 3](#)

[Channel 1](#)

[Channel 2](#)

[Meaning of the Link Quality Indicator](#)

Home screens 2 and 3

- ▷ Turn the **jog dial** on the home screen to the right.
 - ➔ The second home screen appears with network information for the device.
- ▷ Turn the **jog dial** to the right again.
 - ➔ The third home screen appears with information about the software and hardware.

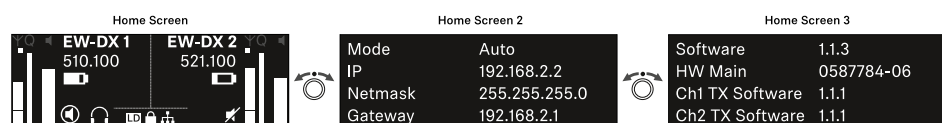



Channel 1

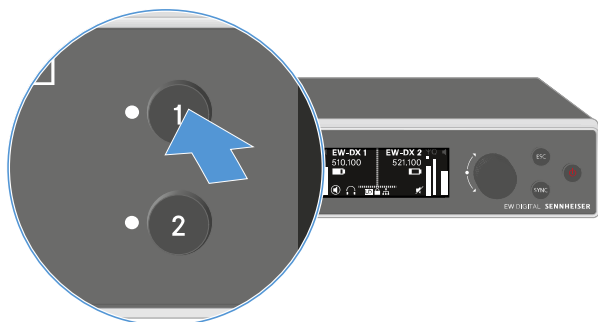

- ▷ On the receiver's home screen, press the **CH 1** button.
- ➔ The home screen for channel 1 appears.

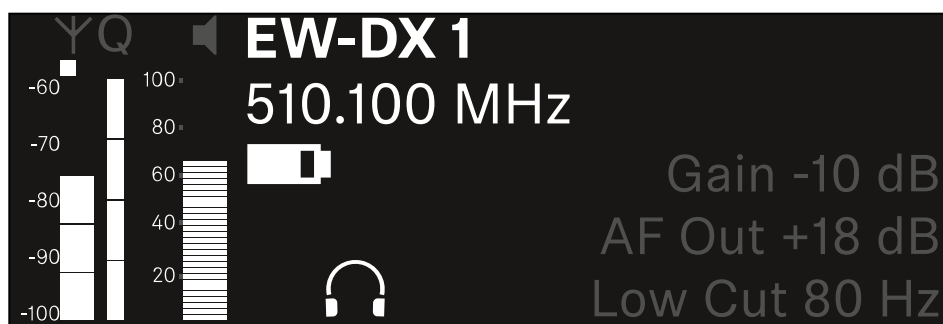

In addition to the status information displayed on the home screen, information about the channel's audio settings is also displayed.

- ▷ Turn the **jog dial** to the right to view more information about the received transmitter.

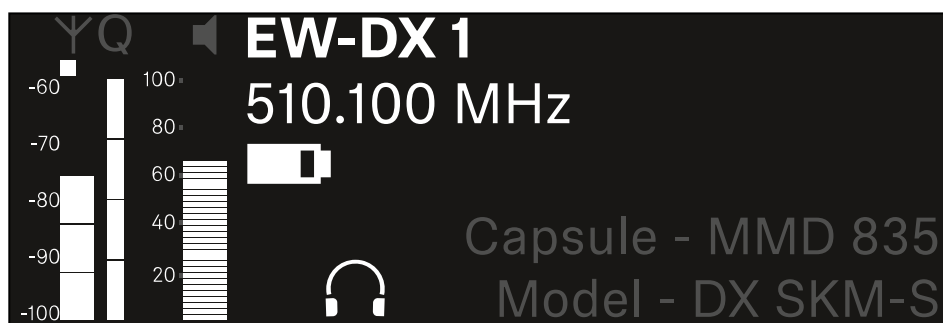



- ▷ Turn the **jog dial** further to the right to mute or unmute the channel's audio signal.

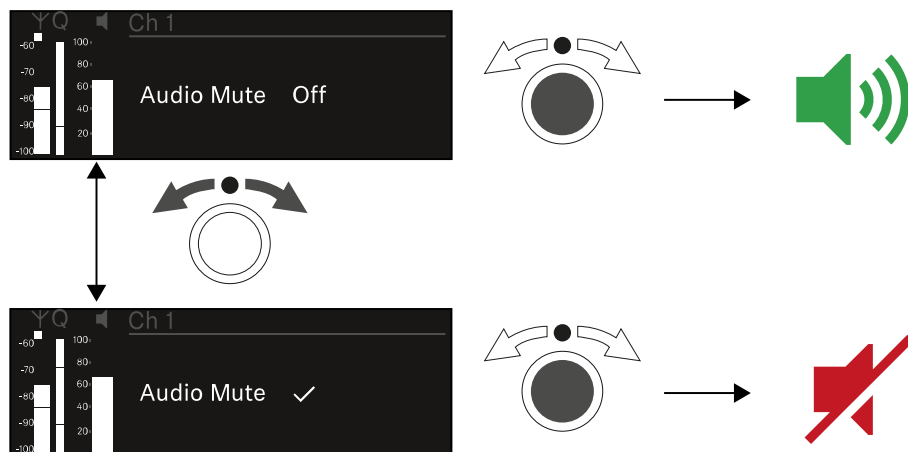

- ▷ Press the **jog dial** to confirm your selection.



Channel 2

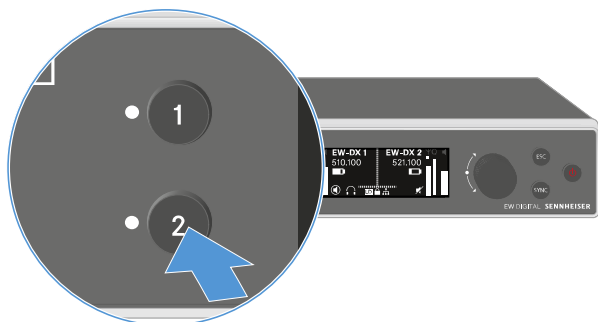

- ▷ On the receiver's home screen, press the **CH 2** button.
 - ➔ The home screen for channel 2 appears.

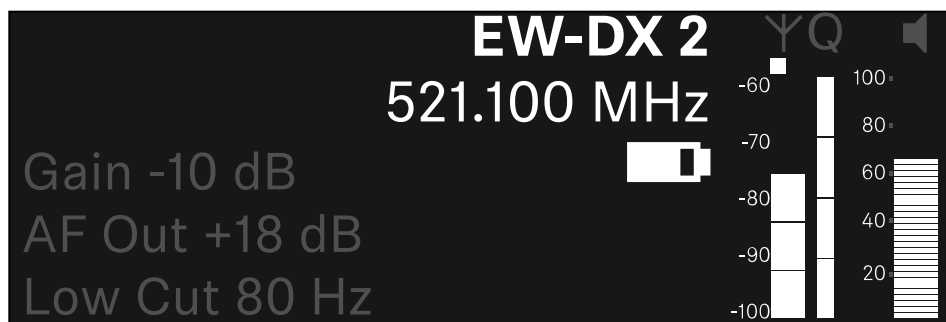

You can view and configure the same information as for channel 1, see [Channel 1](#).



Meaning of the Link Quality Indicator

The **LQI** (Link Quality Indicator) on the display of the receiver shows the transmission quality for the respective channel.

On the one hand, the transmission quality depends on the field strength (**RF** indicator on the receiving channel display). However, on the other hand, it also depends on external sources of interference that cannot be identified on the **RF** indicator (for example, they may be on the same frequency or a very close neighboring frequency or may not affect the RF strength).

As a basic principle, an LQI value significantly higher than 50% should be achieved for a secure transmission.

The LQI display shows the following information:

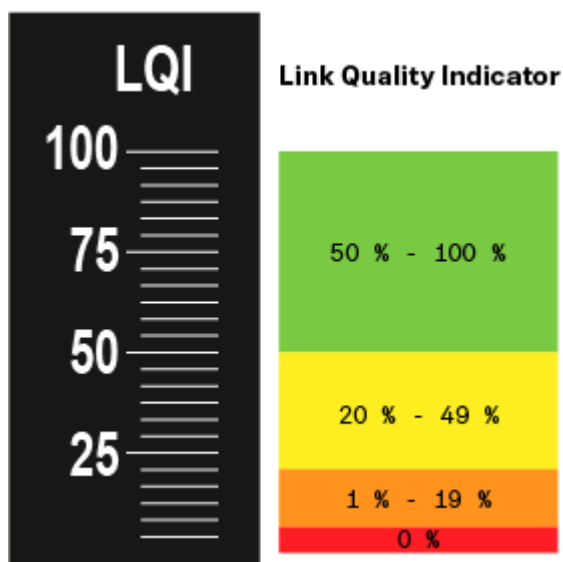

Green range from 50% to 100%:

- No transmission errors

The transmission quality is good enough to ensure an audio quality of 100%.

Yellow range from 20% to 49%:

- Individual transmission errors: short-term error correction active
- Individual audio artifacts may be audible

There are initial transmission errors. In rare cases, there are initial audible audio artifacts. Error correction may be active in this case.



Orange range from 1% to 19%:

- Frequent transmission errors: long-term error correction active
- Risk of audio drop-outs

The transmission errors increase, which means that the error correction duration also increases. There is a risk of audio drop-outs.

Red range 0%:

- No transmission

In this range, the transmission quality is so poor that audio drop-outs can no longer be avoided.



Buttons for navigating the menu

Use the following buttons to navigate through the receiver's operating menu.

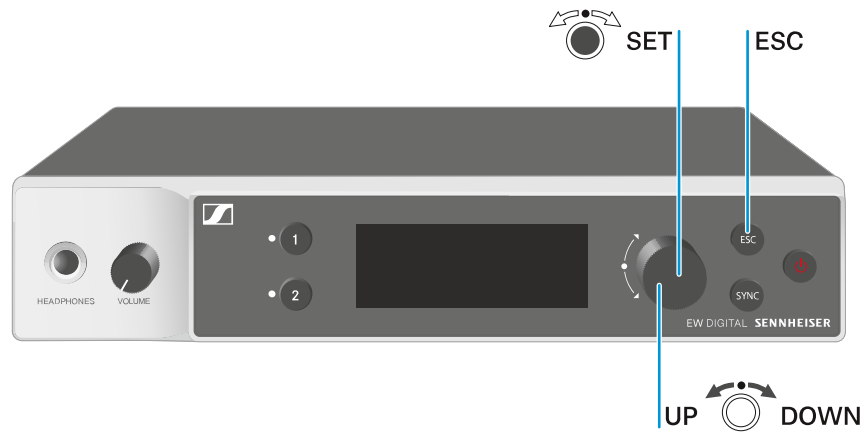

Press the **jog dial**

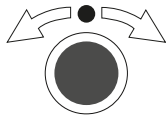

- Jumps from the home screen to the operating menu
- Calls up a menu item
- Changes to a submenu
- Saves settings

Turn the **jog dial**

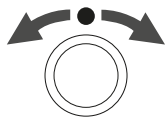

- Selects a standard display (see [Displays on the receiver's display panel](#))
- Changes to the previous or next menu item
- Changes the setting of a menu item

Press the **ESC** button



- Cancels the entry and returns to the previous display

i [Opening the menu and navigating the menu items](#)



Opening the menu and navigating the menu items

To open the menu:

- ▷ Press the **jog dial** when you are on the **home screen**.

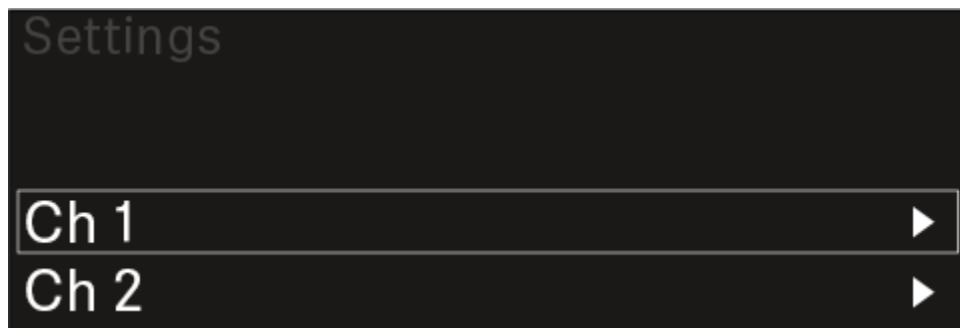

- ▷ Turn the **jog dial** to navigate to your desired menu item.
- ▷ Press the **jog dial** to open the selected menu item.

To exit the menu:

- ▷ Press the **ESC** button to exit the menu and return to the **home screen**.
 - ➡ Changes that were not previously saved by pressing the **jog dial** will be lost.

Related information

[Menu structure](#)

[Setting options in the menu](#)

[System menu item](#)



Menu structure

The figure shows the complete menu structure in an overview.

Version: firmware 3.0.0

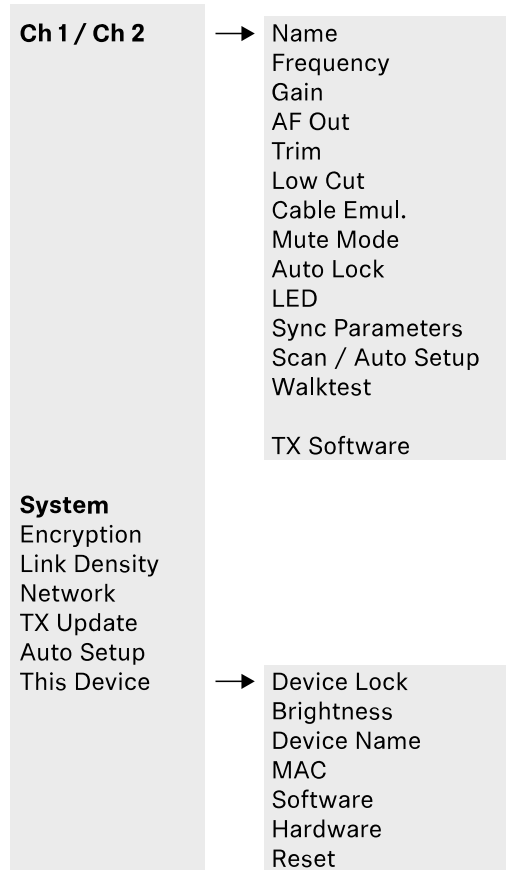



Setting options in the menu

In the receiver menu, you can configure the following settings.

Changing the name of the radio link

- [Ch 1 / Ch 2 -> Name menu item](#)

Adjusting frequencies

- [Ch 1 / Ch 2 -> Frequency menu item](#)

Adjusting the gain of the wireless link

- [Ch 1 / Ch 2 -> Gain menu item](#)

Setting the output level of the audio signal

- [Ch 1 / Ch 2 -> AF Out menu item](#)

Adjusting the trim of the connected transmitter

- [Ch 1 / Ch 2 -> Trim menu item](#)

Adjusting the low-cut filter

- [Ch 1 / Ch 2 -> Low Cut menu item](#)

Configuring cable emulation for the bodypack transmitter

- [Ch 1 / Ch 2 -> Cable Emul. menu item](#)

Setting the function of the transmitter's mute switch

- [Ch 1 / Ch 2 -> Mute Mode menu item](#)

Enabling the transmitter's automatic lock-off function

- [Ch 1 / Ch 2 -> Auto Lock menu item](#)

Configuring the behavior of the transmitter's LEDs

- [Ch 1 / Ch 2 -> LED menu item](#)

Activating/deactivating the parameters to be synchronized on the transmitters

- [Ch 1 / Ch 2 -> Sync Parameters menu item](#)



Performing a frequency scan and automatic frequency setup

- [Ch 1 / Ch 2 -> Scan / Auto Setup menu item](#)

check the reception quality within the operating environment

- [Ch 1 / Ch 2 -> Walktest menu item](#)

Viewing the software version of the connected transmitters

- [Ch 1 / Ch 2 -> TX Software menu item](#)

Configuring different system settings

- Enabling AES 256 encryption
- Setting transmission mode
- Configuring network settings
- Updating the firmware for the transmitters
- Activating the Auto Setup function
- Changing device names
- [System menu item](#)

i You can find an overview of the entire menu structure under [Menu structure](#).

Ch 1 / Ch 2 -> Name menu item

In the **Name** menu item, you can define the name of the link for the channel in question.

i This name is the name of the radio link between the transmitter and receiving channel. You can set the name of the receiver as it will appear in a network from the **This Device** menu in the system menu. See [System -> This Device menu item](#).



To open the Name menu item:

- ▷ In the menu, navigate to the **Name** menu item for the desired channel.

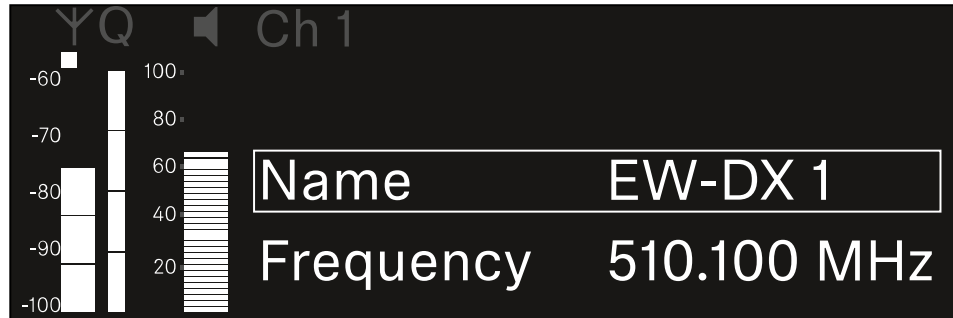

- ▷ Press the **jog dial** to open the menu.

➔ The following view is displayed:

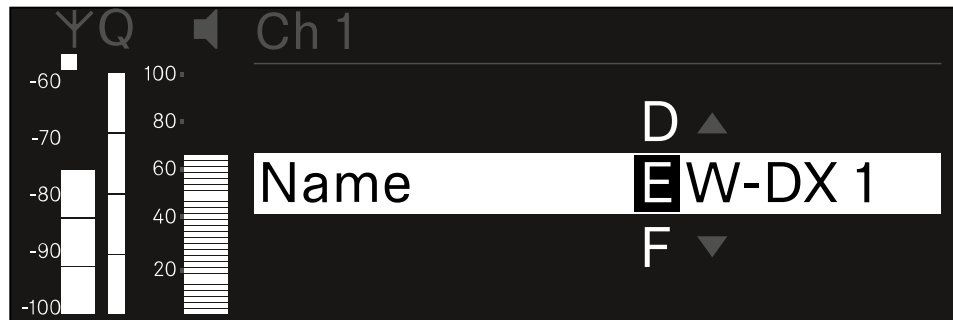

To enter the desired link name:

- ▷ Turn the **jog dial** to select the desired character.
 - ▷ Press the **jog dial** to go to the next position.
 - ▷ At the last position, press the **jog dial** to save the selected name.
- Or
- ▷ Press the **ESC** button to cancel the entry without saving the settings.

i For the chosen link name to appear on the display of the received transmitter, you must synchronize the channel ([Connecting to the EW-DX EM receivers / synchronizing the EW-DX EM](#)).



Ch 1 / Ch 2 -> Frequency menu item

In the **Frequency** menu item, you can adjust the frequency for the channel in question.

You can select a frequency from the predefined list or set the frequency manually.

To open the Frequency menu item:

- ▷ In the menu, navigate to the **Frequency** menu item for the desired channel.

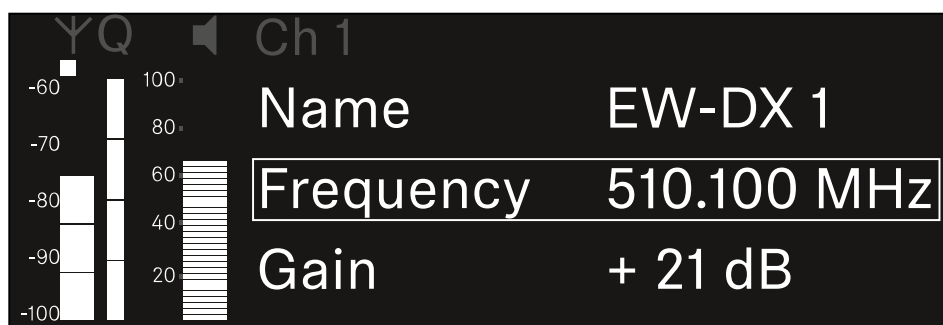

- ▷ Press the **jog dial** to open the menu.

➔ The following view is displayed:

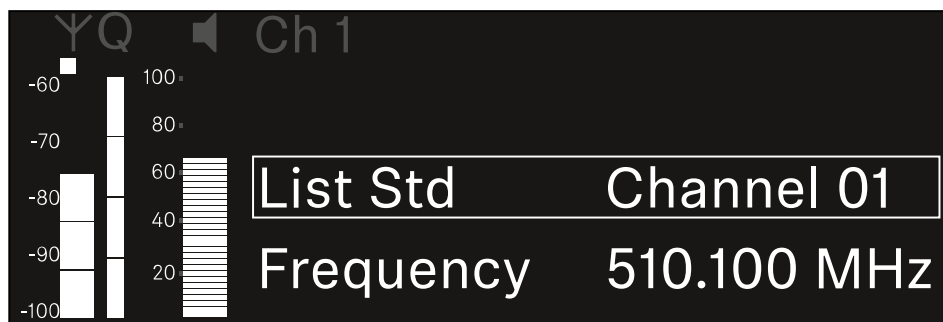

- ▷ Rotate the **jog dial** to select between the **List** and **Frequency** subitems.

➔ The **List** subitem allows you to select a frequency from the predefined list. The **Frequency** subitem lets you set the desired frequency manually.



To select a frequency from a predefined list:

- ▷ Open the **List** subitem.

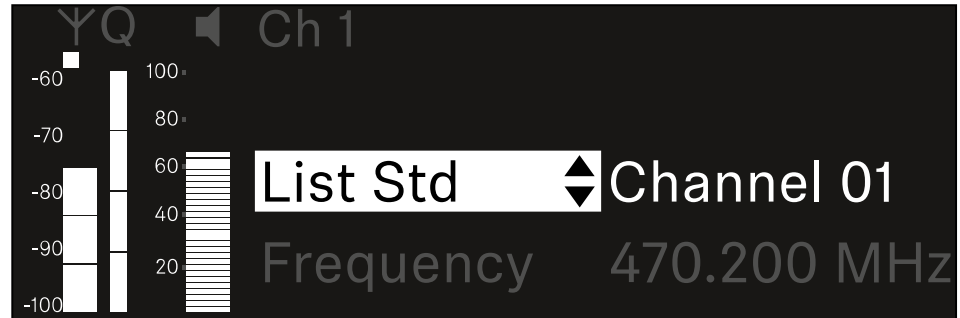

- ▷ Rotate the **jog dial** to choose between the predefined list (**List Std**) and the user-defined list (**List Usr**).

i You can create a custom list using the **Wireless Systems Manager** (WSM) software and upload it to the receiver. For more information on the **WSM** software, see:

sennheiser.com/wsm

- ▷ Press the **jog dial** to confirm your selection.

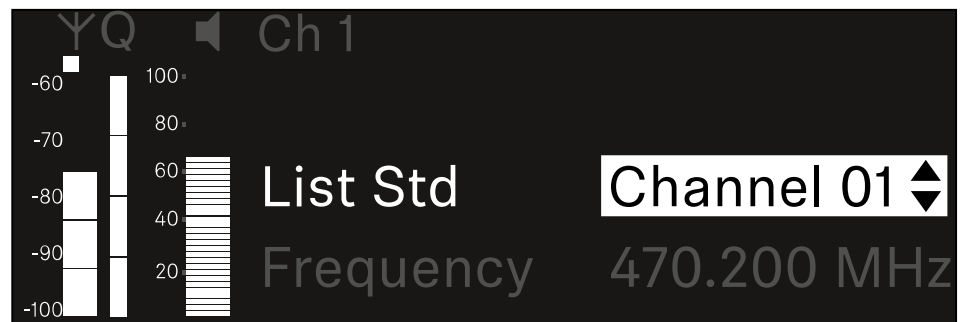

- ▷ Rotate the **jog dial** to select the desired channel from the list.
 - ➔ The frequency assigned to the channel is displayed.
- ▷ Press the **jog dial** to save the selected channel.
 - Or
- ▷ Press the **ESC** button to cancel the entry without saving the settings.



To set the frequency manually:

- ▷ Open the **Frequency** subitem.

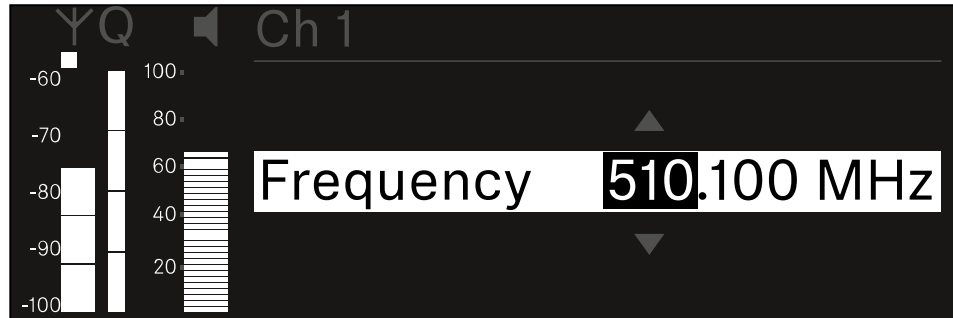

- ▷ Turn the **jog dial** to set the MHz range for the frequency.
- ▷ Press the **jog dial** to confirm your selection.

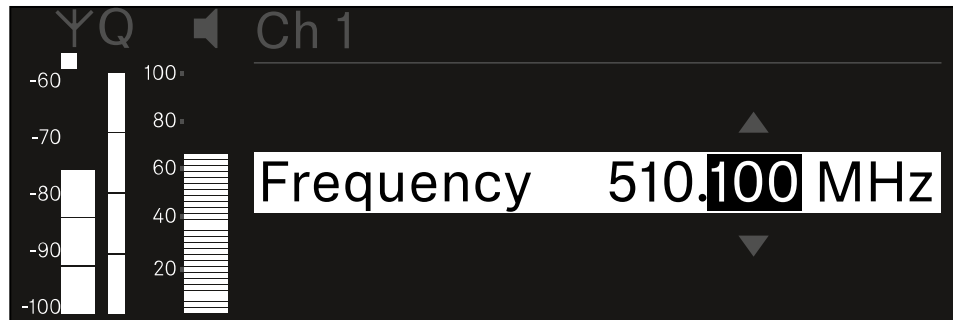

- ▷ Turn the **jog dial** to set the kHz range for the frequency.
- ▷ Press the **jog dial** to save your selected frequency.or
Or
- ▷ Press the **ESC** button to cancel the entry without saving the settings.



Ch 1 / Ch 2 -> Gain menu item

Under the **Gain** menu item, you can set the audio level of the audio signal coming from the received transmitter (e.g. vocals or speech via EW-DX SKM or guitar via EW-DX SK).

- Setting range: **-3 dB** to **+42 dB** in increments of 3 dB

To open the Gain menu item:

- ▷ In the menu, navigate to the **Gain** menu item for the desired channel.

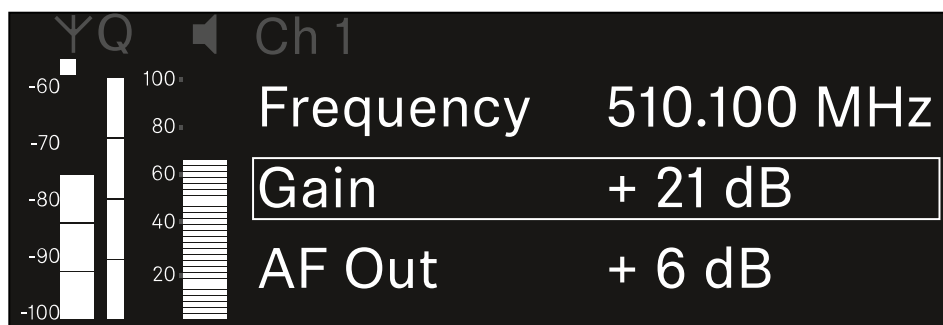

- ▷ Press the **jog dial** to open the menu.
➔ The following view is displayed:

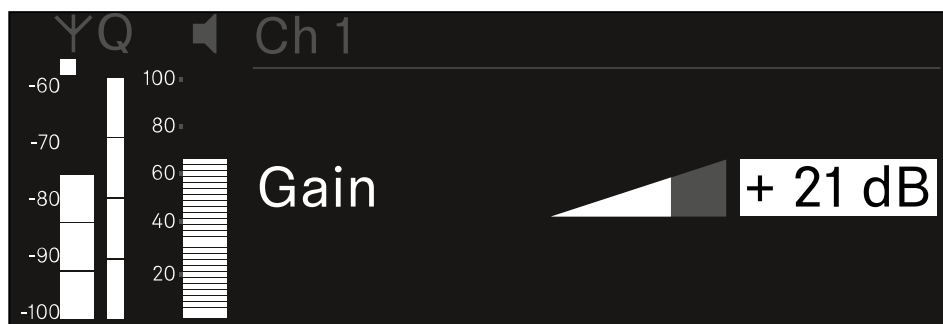

- ▷ Turn the **jog dial** to set the desired value.
- ▷ Press the **jog dial** to save your setting.
- Or
- ▷ Press the **ESC** button to cancel the entry without saving the settings.



Ch 1 / Ch 2 -> AF Out menu item

In the **AF Out** menu item, you can set the audio level that is output via the audio outputs of the particular receiving channel.

To open the **AF Out** menu item:

- ▷ In the menu, navigate to the **AF Out** menu item for the desired channel.



- ▷ Press the **jog dial** to open the menu.

➔ The following view is displayed:

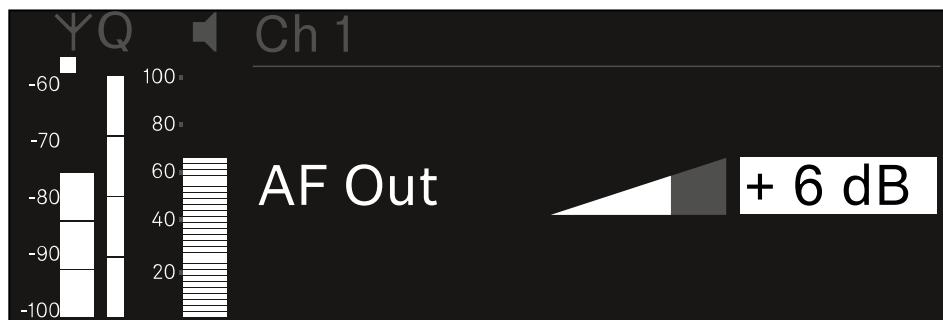

- ▷ Turn the **jog dial** to set the desired value.
- ▷ Press the **jog dial** to save your setting.
- Or
- ▷ Press the **ESC** button to cancel the entry without saving the settings.



Ch 1 / Ch 2 -> Trim menu item

In the **Trim** menu item, you can adjust the audio level of the received transmitter to input signals of different volumes.

- i** For example, if you are using multiple transmitters in alternation for a single receiving channel, you can adjust the transmitters to the different input signals using the trim setting. You do not need to change the channel's gain setting.

- Setting range: **-12 dB** to **+6 dB** in increments of 1 dB

To open the Trim menu item:

- ▷ In the menu, navigate to the **Trim** menu item for the desired channel.



- ▷ Press the **jog dial** to open the menu.

➔ The following view is displayed:

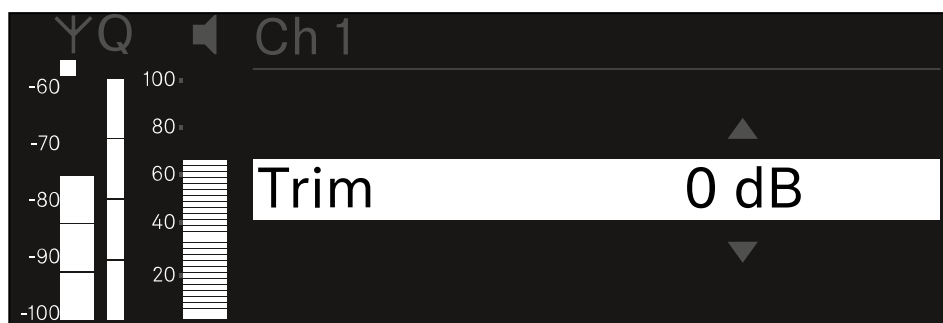

- ▷ Turn the **jog dial** to set the desired value.
- ▷ Press the **jog dial** to save your setting.
- Or
- ▷ Press the **ESC** button to cancel the entry without saving the settings.



- i** For the set value to be applied to the received transmitter, you must synchronize the channel ([Connecting to the EW-DX EM receivers / synchronizing the EW-DX EM](#)).



Ch 1 / Ch 2 -> Low Cut menu item

In the **Low Cut** menu item, you can set the value of the low cut filter for the respective channel.

Setting range:

- For **EW-DX SK | EW-DX SK 3-PIN**: Off, 30 Hz, 60 Hz, 80 Hz, 100 Hz, 120 Hz
- For **EW-DX SKM | EW-DX SKM-S**: 60 Hz, 80 Hz, 100 Hz, 120 Hz

To open the **Low Cut** menu item:

- ▷ In the menu, navigate to the **Low Cut** menu item for the desired channel.

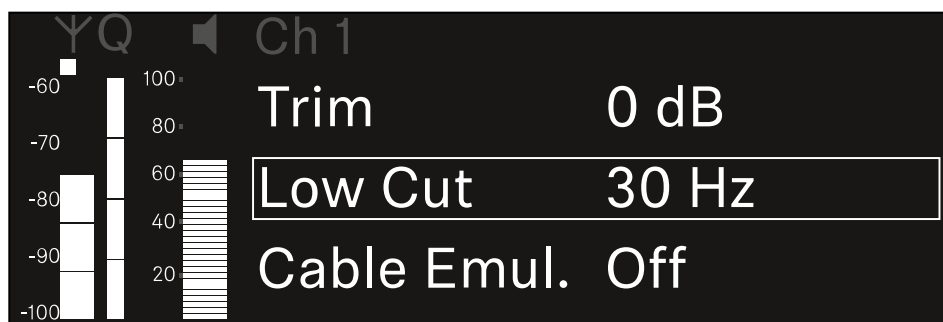

- ▷ Press the **jog dial** to open the menu.

➔ The following view is displayed:

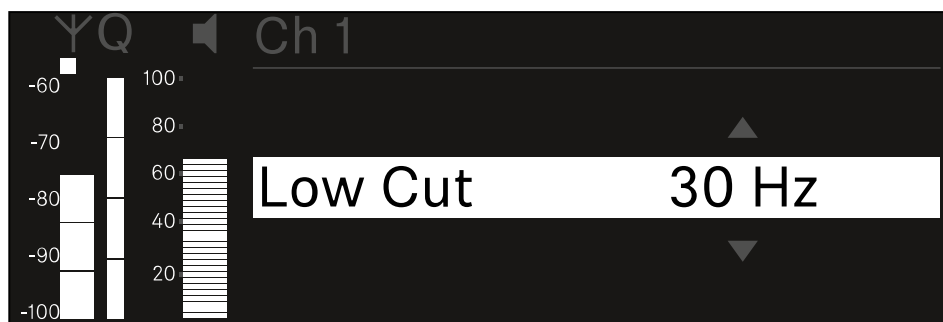

- ▷ Turn the **jog dial** to set the desired value.
- ▷ Press the **jog dial** to save your setting.
- Or
- ▷ Press the **ESC** button to cancel the entry without saving the settings.

i For the set value to be applied to the received transmitter, you must synchronize the channel ([Connecting to the EW-DX EM receivers / synchronizing the EW-DX EM](#)).



Ch 1 / Ch 2 -> Cable Emul. menu item

In the **Cable Emul.** menu item, you can emulate instrument cable lengths:

Setting range:

- Off, Type 1, Type 2, Type 3

To open the Cable Emul. menu item:

- ▷ In the menu, navigate to the **Cable Emul.** menu item for the desired channel.

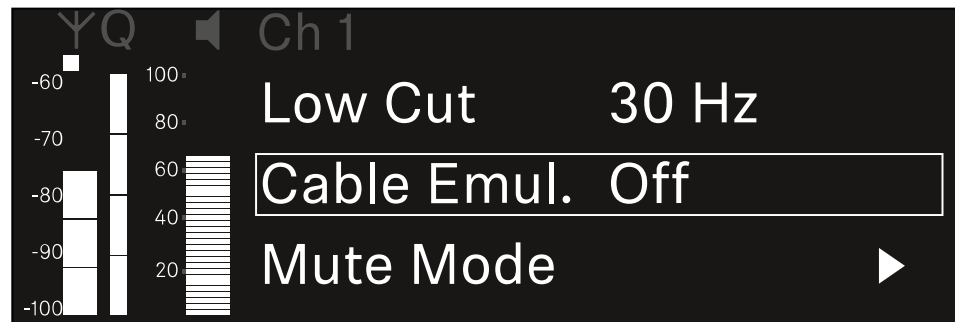

- ▷ Press the **jog dial** to open the menu.

➡ The following view is displayed:

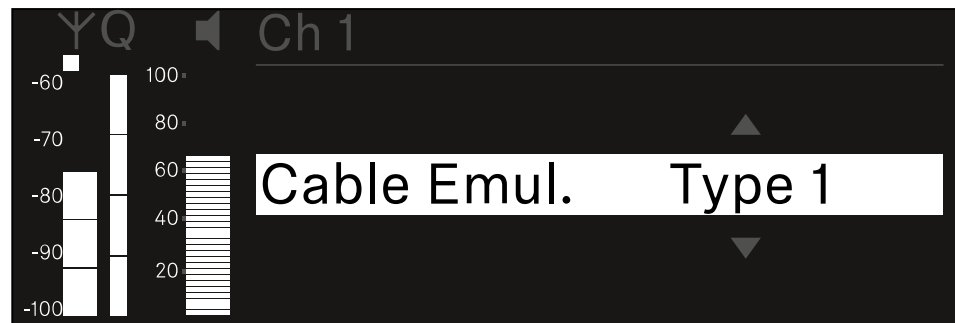

- ▷ Turn the **jog dial** to set the desired value.
- ▷ Press the **jog dial** to save your setting.
- Or
- ▷ Press the **ESC** button to cancel the entry without saving the settings.



Ch 1 / Ch 2 -> Mute Mode menu item

In the **Mute Mode** menu item, you can set the function of the mute switch on the connected transmitter (EW-DX SK, EW-DX SK 3-PIN, EW-DX SKM-S, EW-DX TS).

EW-DX SKM-S, EW-DX SK/EW-DX SK 3-PIN setting range:

- **Disabled:** The mute switch has no function.
- **RF Mute:** The RF signal is deactivated when the mute switch is on.
- **AF Mute:** The audio signal is muted when the mute switch is on.

EW-DX TS setting range:

- **Disabled:** The **MUTE** button has no function.
- **AF Mute:** The audio signal is muted when the **MUTE** button is pressed. Pressing the button again activates the audio signal.
- **PTT (Push to talk):** Press and hold the **MUTE** button to activate the audio signal.
- **PTM (Push to mute):** Press and hold the **MUTE** button to mute the audio signal.

To open the Mute Mode menu item:

- ▷ In the menu, navigate to the **Mute Mode** menu item for the desired channel.

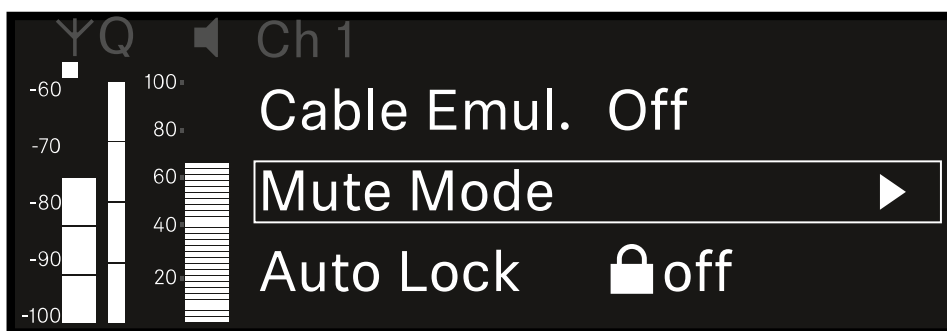

- ▷ Press the **jog dial** to open the menu.

➔ The following view is displayed:

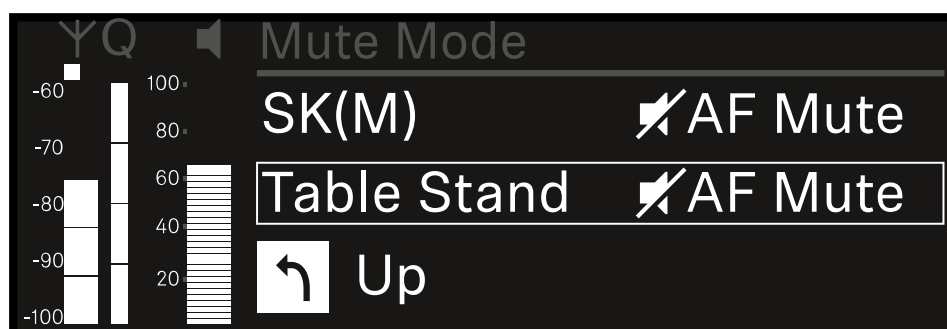



- ▷ Turn the **jog dial** to set the desired value.
- ▷ Press the **jog dial** to save your setting.
Or
- ▷ Press the **ESC** button to cancel the entry without saving the settings.

i For the set value to be applied to the received transmitter, you must synchronize the channel ([Connecting to the EW-DX EM receivers / synchronizing the EW-DX EM](#)).



Ch 1 / Ch 2 -> Auto Lock menu item

In the **Auto Lock** menu item, you can activate or deactivate the lock-off for the received transmitter.

The lock-off prevents the transmitter from being unintentionally switched off and also prevents any changes to the transmitter's menu.

i If you want to change settings in the transmitter's menu while the lock-off is active, you have to temporarily disable the lock-off:

- EW-DX SKM: [Lock-off function](#)
- EW-DX SK: [Lock-off function](#)

To open the **Auto Lock** menu item:

- ▷ In the menu, navigate to the **Auto Lock** menu item for the desired channel.

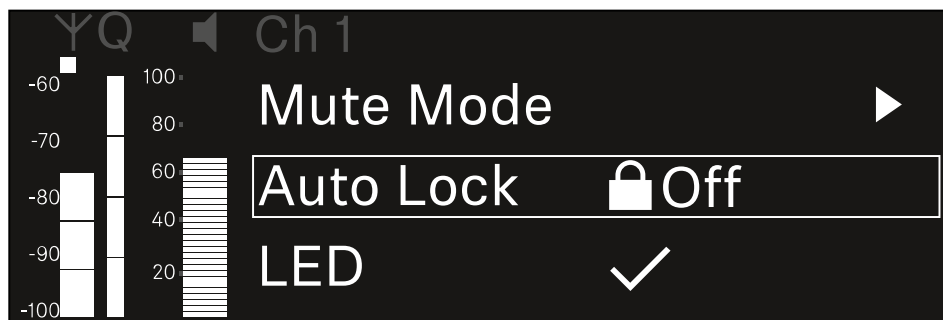

- ▷ Press the **jog dial** to open the menu.

➔ The following view is displayed:

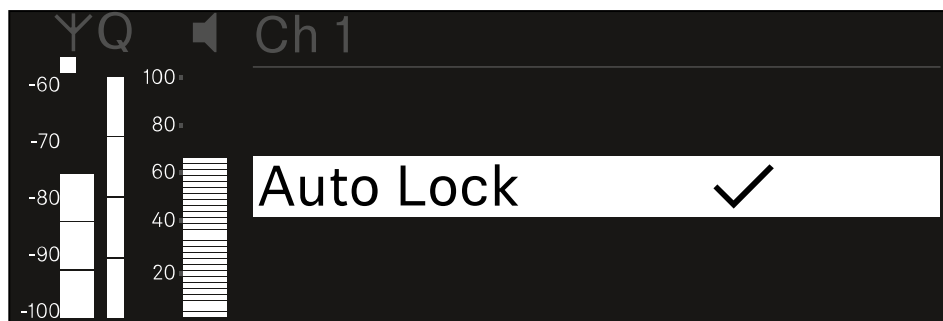

- ▷ Turn the **jog dial** to set the desired value.
- ▷ Press the **jog dial** to save your setting.
- Or
- ▷ Press the **ESC** button to cancel the entry without saving the settings.



- i** For the set value to be applied to the received transmitter, you must synchronize the channel ([Connecting to the EW-DX EM receivers / synchronizing the EW-DX EM](#)).



Ch 1 / Ch 2 -> LED menu item

The **LED** menu item allows you to set the behavior of the LINK LED on the received transmitter.

Setting range:

- **ON:** The LINK LED remains continuously lit.
- **OFF:** The LINK LED switches off while the lock-off function is active.

i For this to occur, the automatic lock-off function must be enabled in the Auto Lock menu item (see [Ch 1 / Ch 2 -> Auto Lock menu item](#)).

To open the LED menu item:

- ▷ In the menu, navigate to the **LED** menu item for the desired channel.

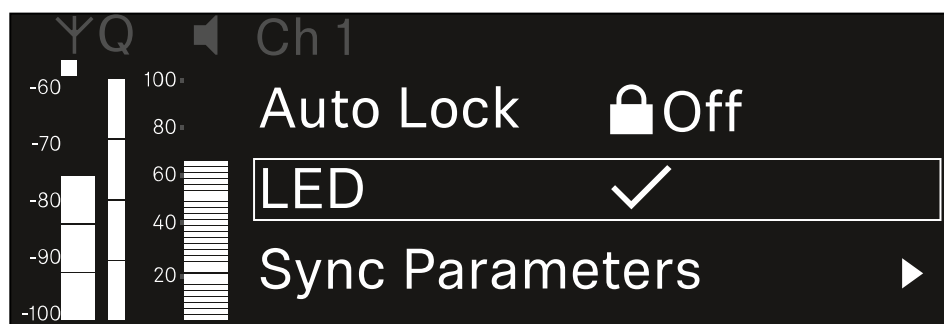

- ▷ Press the **jog dial** to open the menu.

➔ The following view is displayed:

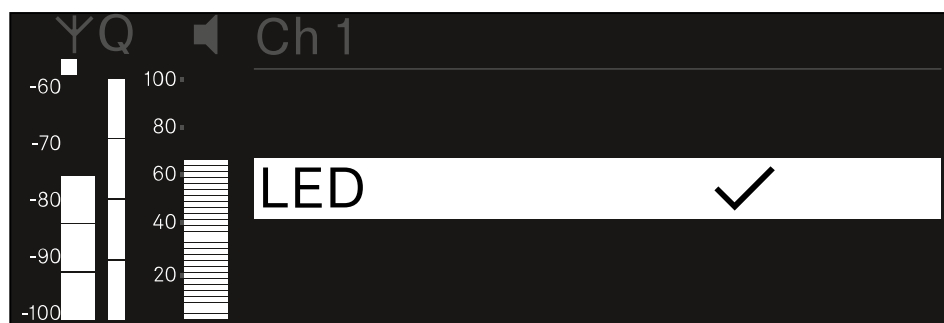

- ▷ Turn the **jog dial** to set the desired value.
- ▷ Press the **jog dial** to save your setting.
Or
- ▷ Press the **ESC** button to cancel the entry without saving the settings.



- i** For the set value to be applied to the received transmitter, you must synchronize the channel ([Connecting to the EW-DX EM receivers / synchronizing the EW-DX EM](#)).



Ch 1 / Ch 2 -> Sync Parameters menu item

In the **Sync Parameters** menu item, you can choose which settings for the transmitter you want to transfer from the receiver to the transmitter during the synchronization.

- i** All of the settings can also be set separately in the menu on the transmitter. During synchronization, the values set in the transmitter are overwritten with the values set in the receiver.

The following parameters can be enabled or disabled for transmission.

- Name
- Frequency
- Trim
- Low Cut
- Cable Emul.
- Mute Mode
- Auto Lock
- LED

To open the Sync Settings menu item:

- ▷ In the menu, navigate to the **Sync Settings** menu item for the desired channel.

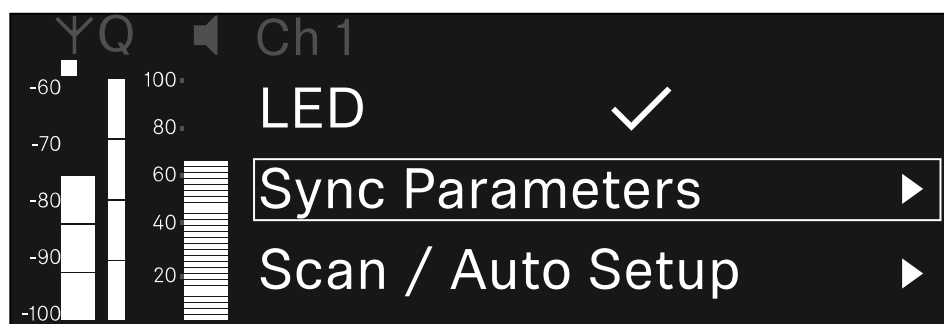

- ▷ Press the **jog dial** to open the menu.



➔ The following view is displayed:

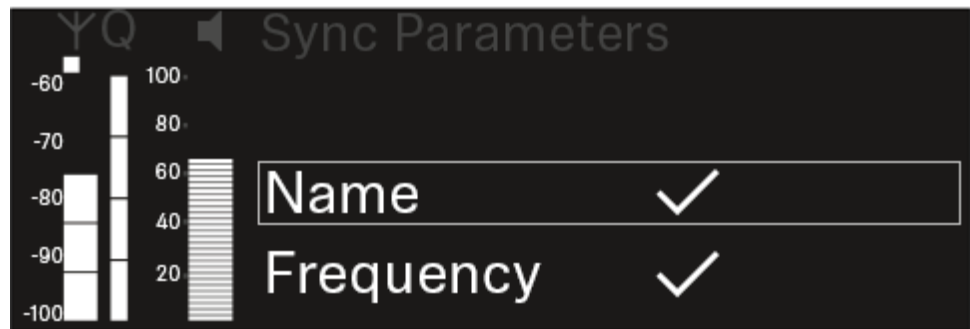

- ▷ Turn the **jog dial** to choose between the options.
- ▷ Press the **jog dial** to open your selected option.

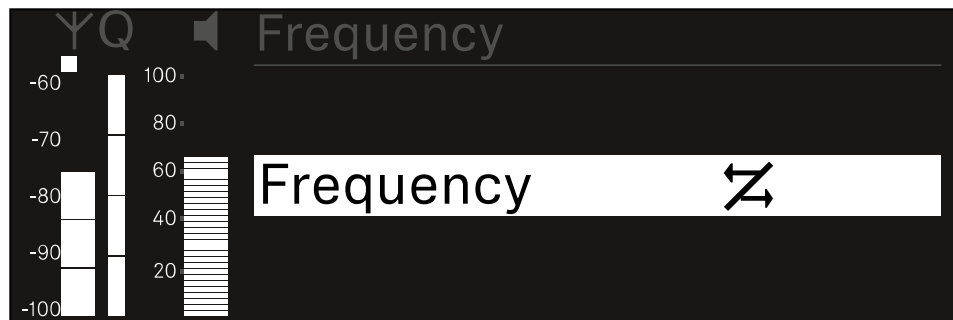
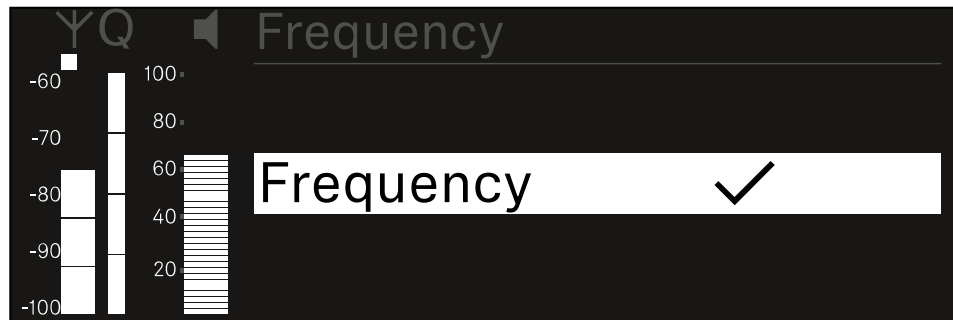

- ▷ For each option, select whether it will be synchronized or not.
 - ✓ The value set for this function will be transferred during synchronization.
 - ✗ The value set for this function will not be transferred during synchronization.

▷ Press the **jog dial** to save your setting.



Ch 1 / Ch 2 -> Scan / Auto Setup menu item

The receiver lets you scan the frequency spectrum and display all of the free frequencies in the selected frequency range. The automatic frequency setup can be used to distribute the free frequencies to all of the EW-DX EM 2 devices available in the network automatically.

▷ Switch off all transmitters before you perform the scan.

➔ If transmitters are still switched on, they are detected as unavailable frequencies and the frequencies that are actually available cannot then be used.

i To perform the automatic frequency setup for all devices in the network, the Auto Setup function must be enabled in the receiver's system menu: [System -> Auto Setup menu item](#)

i An EM that is performing one of the following actions will be excluded from the frequency setup of another EM:

- Remote (full) scan
- Scan Me / Scan Network -> Autosetup
- Bonding
- TX Sync
- TX Update
- Device Update (if in progress)

To open the Scan / Auto Setup menu item:

▷ In the menu, navigate to the **Scan / Auto Setup** menu item for the desired channel.

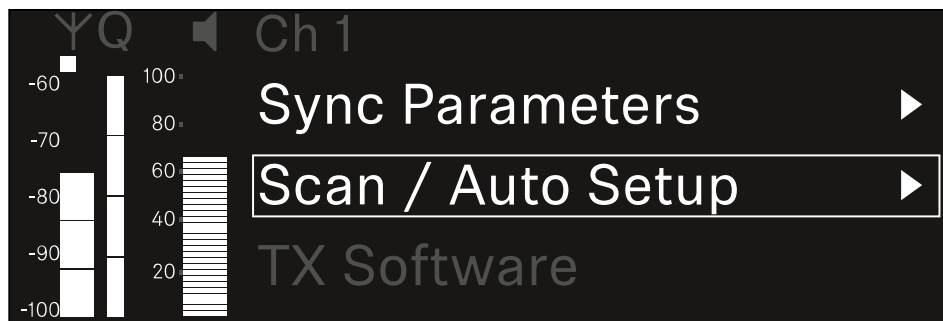

▷ Press the **jog dial** to open the menu.



➔ The following view is displayed:

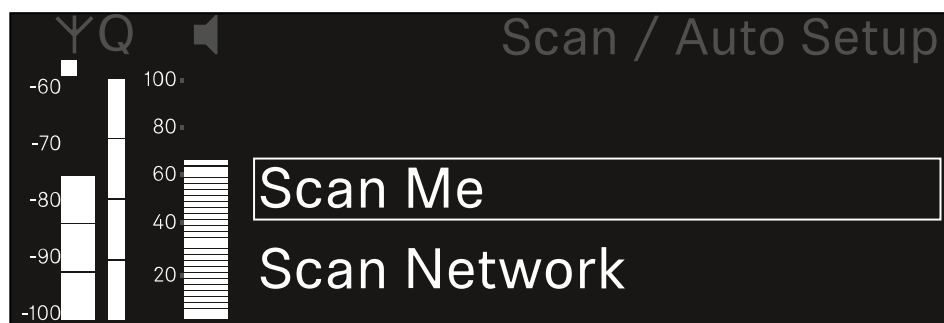

- ▷ Turn the **jog dial** to choose between the **Scan Me** and **Scan Network** options.
 - **Scan Me:** The frequency scan and the frequency setup are performed only for the selected receiving channel.
 - **Scan Network:** The frequency scan and the frequency setup are performed for both channels of the receiver as well as for all other receivers available in the network.
- ▷ Press the **jog dial** to open your selected option.

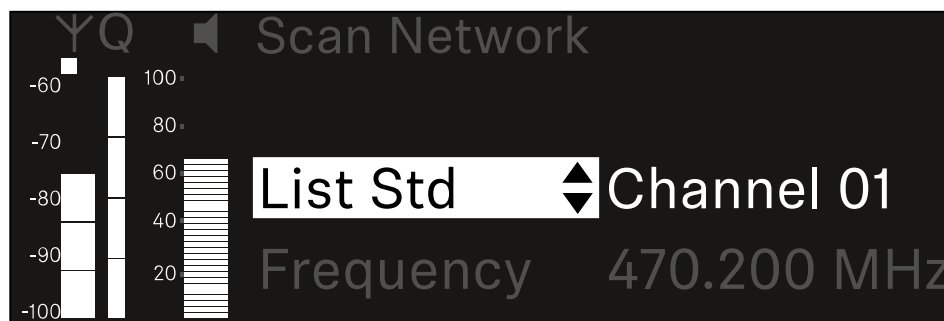

- ▷ Select a frequency from which to start the scan.
- ▷ Press the **jog dial** to start the scan.



➔ The spectrum is scanned for free frequencies above the selected frequency.

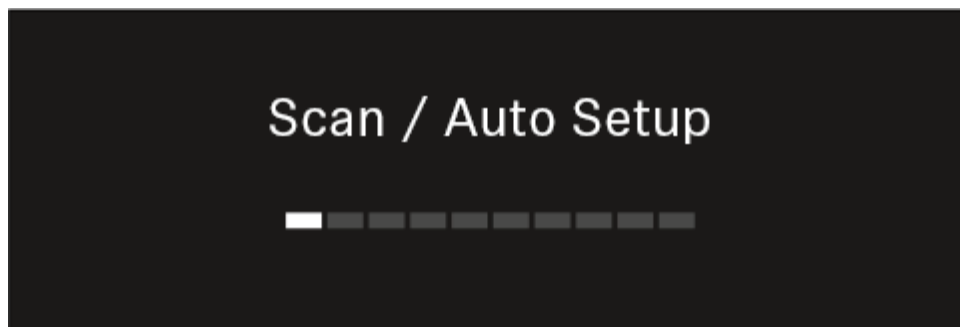

i After the scan free frequencies are displayed, which you can then assign to the channels.

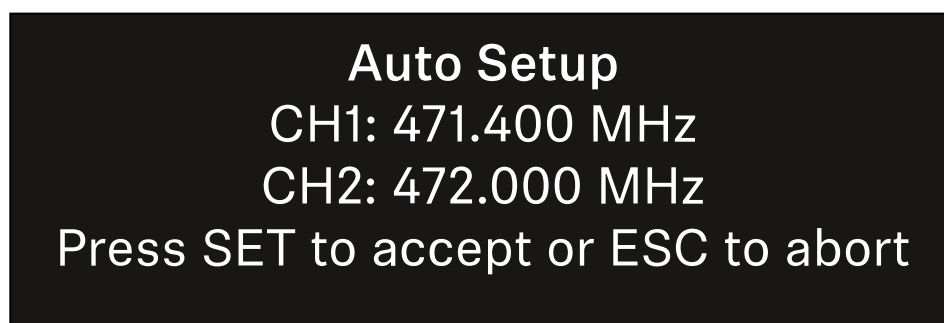

- ▷ Press the **jog dial** to assign the free frequencies to the receiving channels.
Or
- ▷ Press the **ESC** key to cancel and not assign new frequencies.
- ▷ Next, synchronize the receiving channels with the corresponding transmitters to establish the radio link at the new selected frequencies ([Synchronizing the receiver and transmitter](#)).



Ch 1 / Ch 2 -> Walktest menu item

The **Walktest** menu item allows the performance of a reception test.

Once you have set up and installed all of the receivers and transmitters for your event, we recommend performing a walk test. This lets you check whether sufficient reception strength is available throughout the entire area used.

Start the walktest function in this menu item and then walk the entire area with one transmitter. The results of the walk test give you information about the reception quality.

Opening the Walktest menu item

- ▷ In the menu, navigate to the **Walktest** menu item for the desired channel.

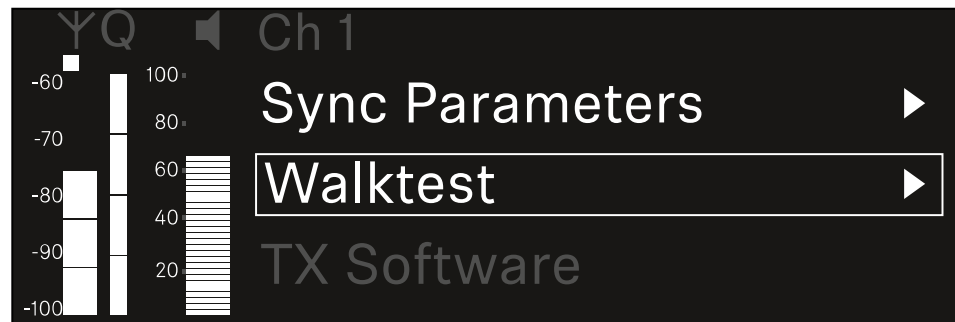

- ▷ Press the **jog dial** to open the menu.

➔ The following view is displayed:



To start the reception test:

- ▷ Press the **jog dial**.
- ▷ Walk the entire area on which you want to operate the system with the transmitter.
 - ➔ The following values are recorded on the display:
 - **RF**: Reception from antenna in dBm
 - **LQI**: Connection quality as a %, see [Meaning of the Link Quality Indicator](#)
 - **AF**: Transmitter audio frequency in dBFS



To end the reception test:

▷ Press the **Jog-Dial** to finish the walk test when you are ready.

ΥQ	Ch 1	Walktest		
		RF	LQI	AF
•				
•	Max	-92.4	0	-138.5
•	Min	-107.0	0	-138.5

Press SET to stop



Ch 1 / Ch 2 -> TX Software menu item

The **TX Software** menu item displays the software version of the received transmitter.

You cannot open this menu item to make settings.

- ▷ In the menu, navigate to the **TX Software** menu item for the desired channel.

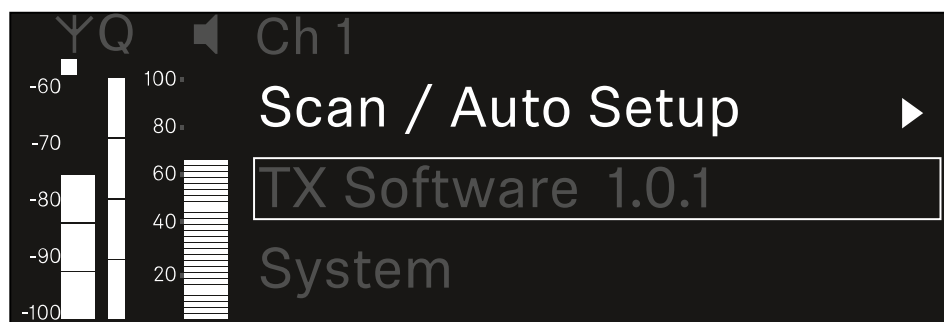

- ➔ The version number of the transmitter software is shown on the display. The transmitter must be switched on for this to be displayed.

i You can find information about updating the transmitter firmware in section [System -> TX Update menu item](#).



System menu item

In the System menu, you can make system-wide settings that will affect the entire device and not only the respective receiving channel.

The following menu items are available:

Encryption

- This menu item lets you secure the radio link with AES 256 encryption.
- [System -> Encryption menu item](#)

Link Density

- In this menu item, you can set the required transmission mode.
- [System -> Link Density menu item](#)

Network

- In this menu item, you can configure the settings for the network connection.
- [System -> Network menu item](#)

TX Update

- This menu item lets you perform a firmware update for the transmitters.
- [System -> TX Update menu item](#)

Auto Setup

- This menu item allows you to activate automatic frequency setup for the receiver.
- [System -> Auto Setup menu item](#)

This Device

- This menu item allows you to enter a device name and display information about the receiver's hardware and software.
- [System -> This Device menu item](#)



System -> Encryption menu item

You can secure the radio link between the transmitter and receiver using AES 256 encryption.

To open the **Encryption** menu item:

- ▷ In the System menu, navigate to the **Encryption** menu item.

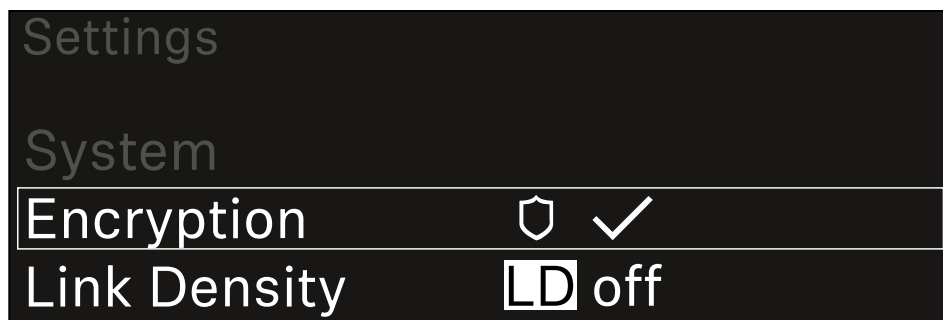

- ▷ Press the **jog dial** to open the menu.
 - ➔ The following view is displayed:

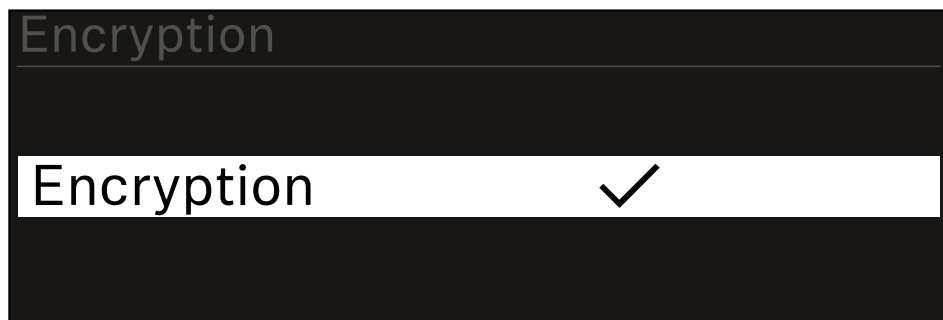

- ▷ Turn the **jog dial** to choose between the **On** and **Off** options.
- ▷ Press the **jog dial** to save your setting.

i After enabling AES 256 encryption, the connected transmitter must be resynchronized with the receiver to enable encryption on the transmitter as well.



System -> Link Density menu item

i Link Density mode (LD mode)

LD mode doubles the number of usable carrier frequencies in the available spectrum, as the minimum distance for the equidistant frequency grid is halved.

This is achieved by reducing the modulation bandwidth of the transmitter. This means that a much smaller frequency spacing between neighboring frequencies can be selected, and therefore more frequencies can be used in the same available spectrum without intermodulation.

LD mode is recommended if the following criteria are met:

- The required number of channels cannot be achieved using the normal mode, as there may be only a small spectrum available.
- The distance between the transmitters and the antennas is not too great.

To open the Link Density menu item:

- ▷ In the System menu, navigate to the **Link Density** menu item.

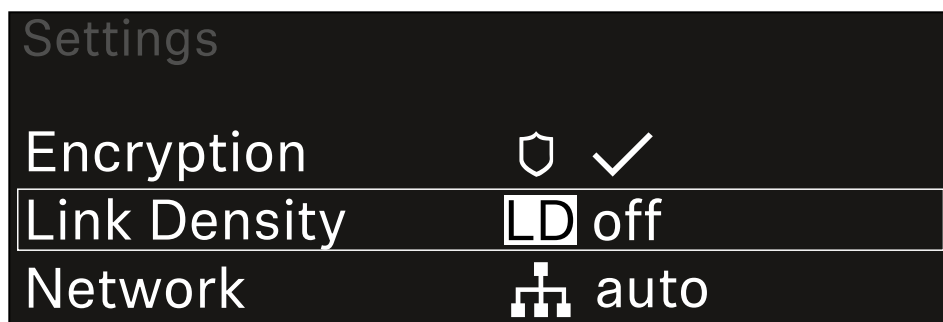

- ▷ Press the **jog dial** to open the menu.

➔ The following view is displayed:



- ▷ Turn the **jog dial** to choose between the **On** and **Off** options.



- ▷ Press the **jog dial** to save your setting.
 - ➔ If you have enabled LD mode, the receiver must be restarted.

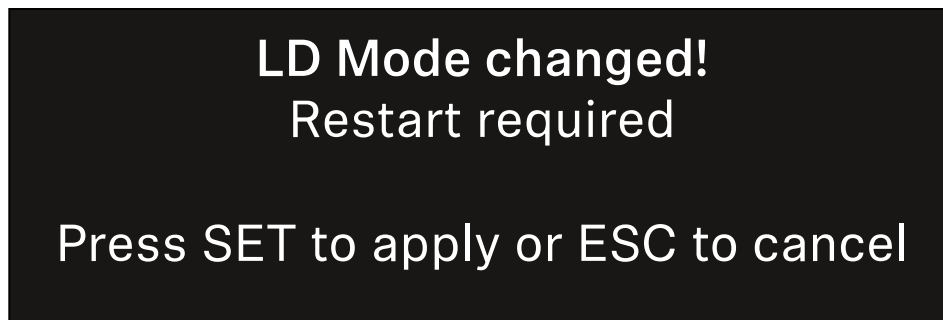

- ▷ Press the **jog dial** to restart the receiver,
 - ▷ or press the **ESC** button to cancel the mode change.

i After enabling LD mode and restarting the receiver, the connected transmitter must be resynchronized with the receiver to enable LD mode on the transmitter as well.



System -> Network menu item

In this menu item, you can configure the settings for the network connection.



To open the Network menu item:

- ▷ In the System menu, navigate to the **Network** menu item.

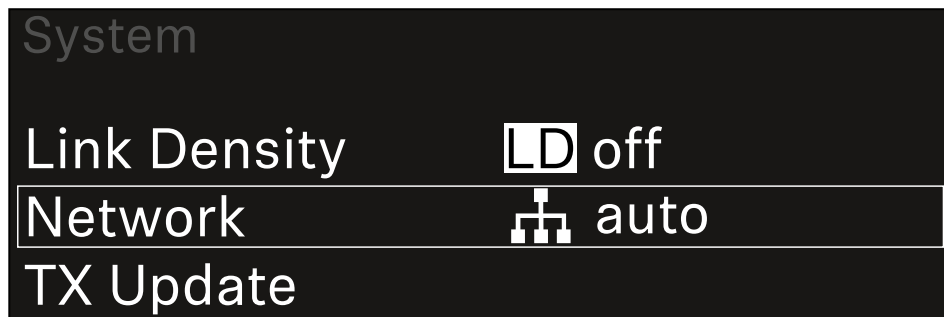

- ▷ Rotate the **jog dial** to navigate through the **Network** menu and select the desired menu item.





➔ You can make the following settings here:

Mode

- **Auto:** The network configuration is performed automatically.
- **Manual:** The network configuration can be performed manually.

mDNS

- You can enable or disable this option if you want to use mDNS for automatic device detection in the network.

IP

- If the **Mode** option is set to **Auto**, the automatically assigned IP address is displayed here.
- If the **Mode** option is set to **Manual**, you can set the IP address here.

Netmask

- If the **Mode** option is set to **Auto**, the automatically assigned netmask is displayed here.
- If the **Mode** option is set to **Manual**, you can set the netmask here.

Gateway

- If the **Mode** option is set to **Auto**, the automatically assigned gateway is displayed here.
- If the **Mode** option is set to **Manual**, you can set the gateway here.

To save the settings you have made:

- ▷ Turn the **jog dial** until **Apply** appears in the selection frame.

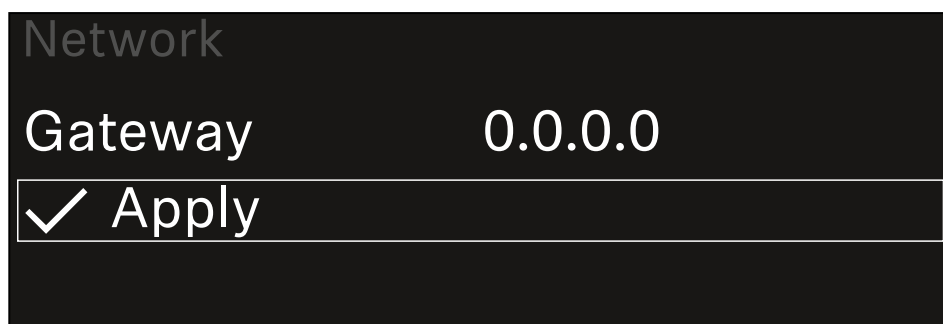

- ▷ Press the **jog dial** to save your settings.



System -> TX Update menu item

This menu item lets you perform a firmware update for the transmitters. This update is recommended after you perform a firmware update for the receiver (see [Updating the firmware of the receiver](#)).

- i** The firmware versions currently installed on the connected transmitter can be viewed under the TX Software menu item for the respective channel (see [Ch 1 / Ch 2 -> TX Software menu item](#)).

To open the TX Update menu item:

- ▷ In the System menu, navigate to the **TX Update** menu item.

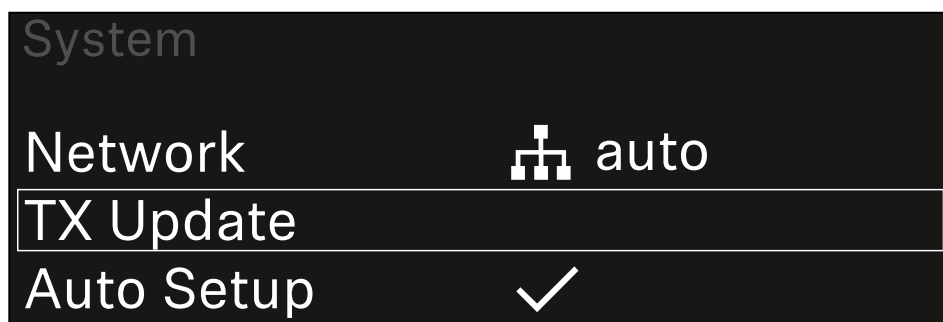

- ▷ Press the **jog dial** to open the menu.
 - ➔ The available sender firmware is displayed:

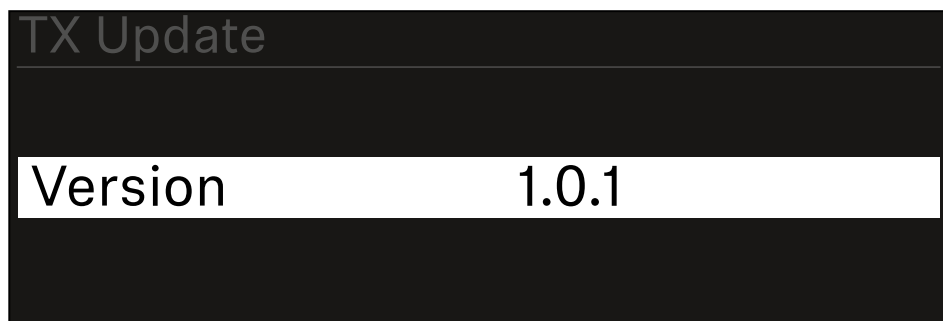



- ▷ Press the **jog dial** to start the firmware update.

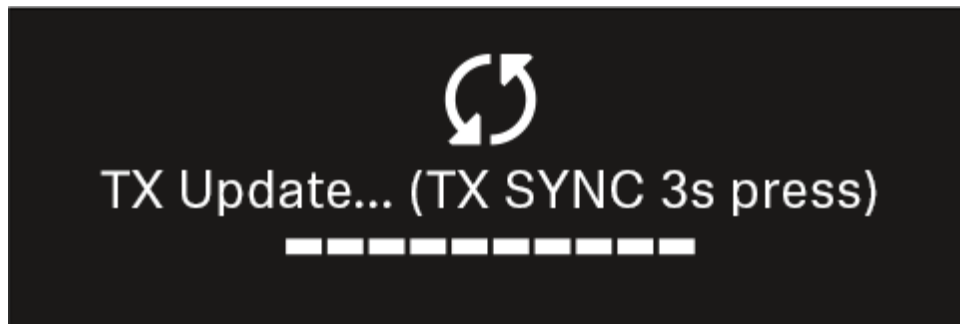

- ▷ Press the **SYNC** button on the connected transmitter for 3 seconds.
 - ➔ You have about 20 seconds to do this. The progress bar shows the remaining time.

The system carries out the firmware update for the transmitter.

The progress of the update is shown on the receiver's display.

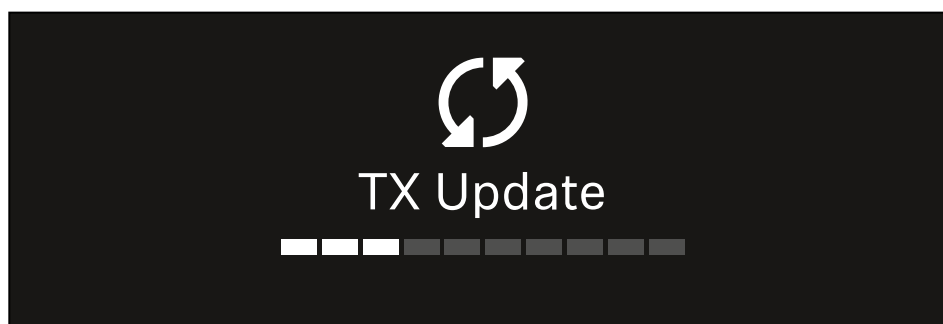

The transmitter's display shows that the firmware update is in progress.

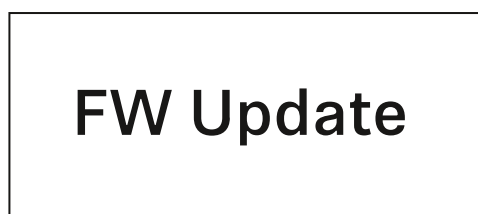



NOTICE



Canceling the update can impair the function of the transmitter

If the transmitter is turned off during the firmware update, the update may fail and the transmitter may cease to function correctly.

- ▷ Do not turn off the transmitter during the update.
- ▷ Do not remove the batteries or rechargeable battery pack during the update.
- ▷ Make sure that the transmitter's (rechargeable) batteries are sufficiently charged before updating.



System -> Auto Setup menu item

In this menu item, you can activate the **Auto Setup** function for the receiver.

If the function is activated here, you can perform an automatic frequency setup for both channels of this receiver via the **Scan / Auto Setup** menu item.

See [Ch 1 / Ch 2 -> Scan / Auto Setup menu item](#).

The receiver will also be enabled for automatic frequency setup in a network consisting of multiple receivers.

If the function is disabled here, you can only assign a frequency to the selected channel of the receiver via the **Scan / Auto Setup** menu item.

To open the Auto Setup menu item:

- ▷ In the System menu, navigate to the **Auto Setup** menu item.

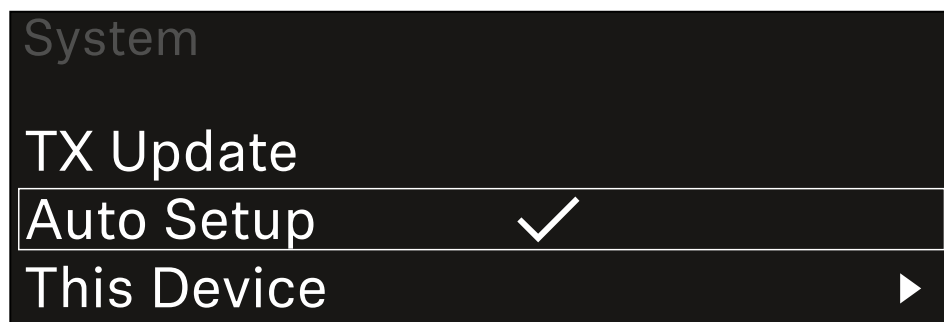

- ▷ Press the **jog dial** to open the menu.

➔ The following view is displayed:

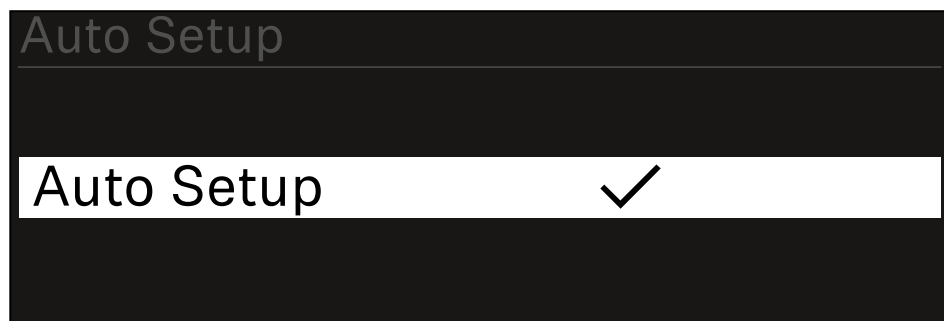

- ▷ Turn the **jog dial** to choose between the **On** and **Off** options.
- ▷ Press the **jog dial** to save your setting.



System -> This Device menu item

This menu item allows you to change the device name, view software and hardware information, or reset the device to factory settings.

To open the **This Device** menu item:

- ▷ In the System menu, navigate to the **This Device** menu item.

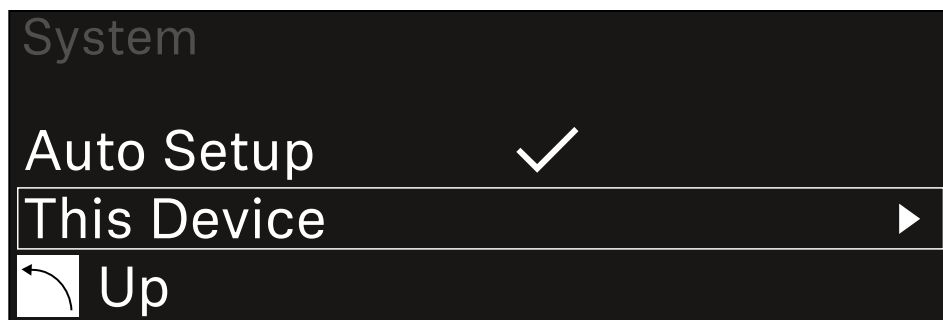

- ▷ Press the **jog dial** to open the menu.

➔ The following view is displayed:

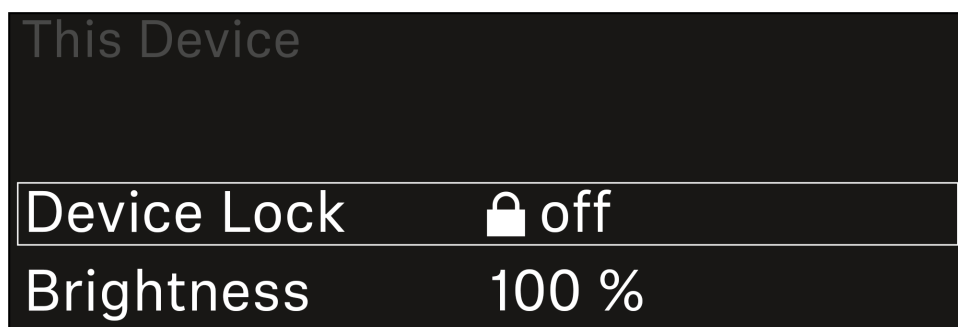

- ▷ Choose from the following:
 - **Device Lock:** Set the lock-off of the receiver.
 - **Brightness:** Set the brightness of the display.
 - **Device Name:** Open this menu item to change the device name. This receiver will be displayed in the network under this name.
 - **MAC:** Shows the MAC address of the receiver.
 - **Software:** Shows the software version of the receiver.
 - **HW Main/HW Front/HW Tuner:** Displays the hardware versions of the boards installed in the receiver.
 - **Reset:** Resets the receiver to factory settings.



Updating the firmware of the receiver

You can update the receiver firmware using the **Sennheiser Control Cockpit** software, the **Wireless Systems Manager** software or the **Smart Assist** app.

Updating with the Sennheiser Control Cockpit or the Wireless Systems Manager:

- ▷ Connect the receiver to a network (see [Connecting receivers in a network](#)) and establish the connection with the software.

i For more information about controlling devices with the **Sennheiser Control Cockpit** or **Wireless Systems Manager** software, refer to the software help.

You can download the software here:

sennheiser.com/control-cockpit-software

sennheiser.com/wsm

i To update the transmitter's firmware, go to System -> TX Update in the menu on the receiver. See [System -> TX Update menu item](#)

Updating with the Smart Assist app:

- ▷ Connect the receiver to a network (see [Connecting receivers in a network](#)).
- ▷ Connect a wireless access point to the network.
- ▷ Connect your smartphone to this network.
- ▷ Start the update process in the **Smart Assist** app:
- ▷ Click on "Update" if the device is on the network.
- ▷ Follow the instructions.
- Or
- ▷ Search for devices that can be updated.
- ▷ Follow the instructions.



EW-DX EM 2 Dante rack receiver

- Product overview
- Connecting/disconnecting the receiver to/from the power supply system
- Connecting receivers in a network
- Connecting receivers in a Dante® network
- Connecting antennas
- Outputting audio signals
- Installing receivers in a rack
- Switching the receiver on and off
- Lock-off function
- Using the headphone output
- Meaning of the LEDs
- Displays on the receiver's display panel
- Home screens 2 and 3
- Channel 1
- Channel 2
- Meaning of the Link Quality Indicator
- Buttons for navigating the menu
- Opening the menu and navigating the menu items
- Menu structure
- Setting options in the menu
 - Ch 1 / Ch 2 -> Name menu item
 - Ch 1 / Ch 2 -> Frequency menu item
 - Ch 1 / Ch 2 -> Gain menu item
 - Ch 1 / Ch 2 -> AF Out menu item
 - Ch 1 / Ch 2 -> Trim menu item
 - Ch 1 / Ch 2 -> Low Cut menu item
 - Ch 1 / Ch 2 -> Cable Emul. menu item
 - Ch 1 / Ch 2 -> Mute Mode menu item
 - Ch 1 / Ch 2 -> Auto Lock menu item
 - Ch 1 / Ch 2 -> LED menu item
 - Ch 1 / Ch 2 -> Sync Parameters menu item
 - Ch 1 / Ch 2 -> Scan / Auto Setup menu item
 - Ch 1 / Ch 2 -> TX Software menu item
- System menu item
 - System -> Encryption menu item
 - System -> Link Density menu item
 - System -> Network menu item
 - System -> TX Update menu item
 - System -> Auto Setup menu item
 - System -> This Device menu item
- Updating the firmware of the receiver



Product overview

Front

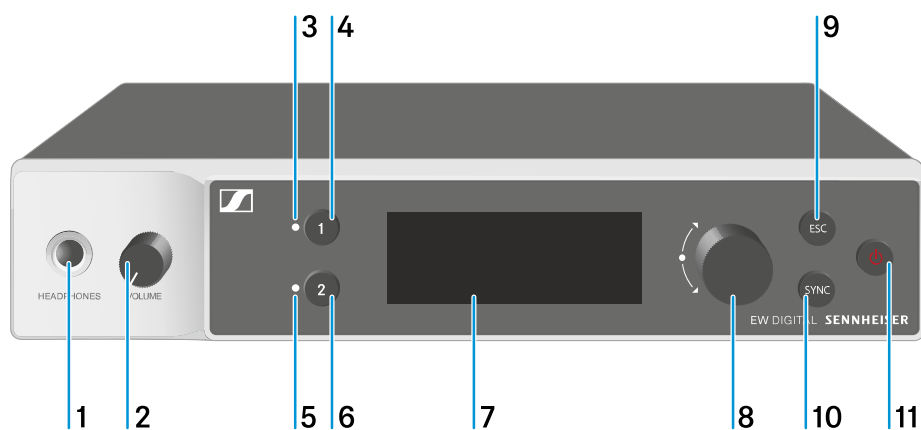

- 1 Headphone socket
 - See [Using the headphone output](#)
- 2 Volume control for the headphone socket
 - See [Using the headphone output](#)
- 3 **CH 1** LED to indicate the status of channel 1
 - See [Meaning of the LEDs](#)
- 4 **CH 1** button for selecting channel 1
 - See [Displays on the receiver's display panel](#)
 - See [Buttons for navigating the menu](#)
- 5 **CH 2** LED to indicate the status of channel 2
 - See [Meaning of the LEDs](#)
- 6 **CH 2** button for selecting channel 2
 - See [Displays on the receiver's display panel](#)
 - See [Buttons for navigating the menu](#)



- 7 Display for status information and operating menu
 - See [Displays on the receiver's display panel](#)
- 8 Jog dial (**UP/DOWN/SET**) for navigating the operating menu
 - See [Buttons for navigating the menu](#)
- 9 **ESC** button for canceling an action in the menu
 - See [Buttons for navigating the menu](#)
- 10 **SYNC** button for synchronizing the transmitter and receiver
 - See [Establishing a radio link | Synchronizing the receiver and transmitter](#)
- 11 **ON/OFF** button for switching the device on and off
 - See [Switching the receiver on and off](#)

Back

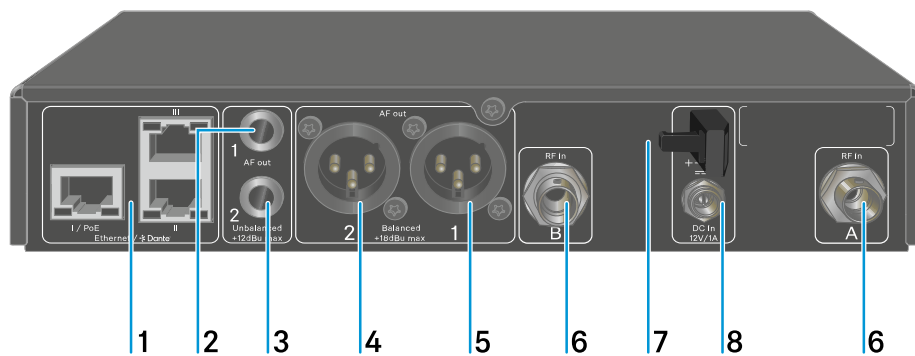

- 1 RJ-45 sockets: **I/PoE** (power supply via Power over Ethernet), **II + III** (control of the device via network using Wireless Systems Manager / Sennheiser Control Cockpit and Dante)
 - See [Connecting receivers in a network](#)
 - See [Connecting/disconnecting the receiver to/from the power supply system](#)



- 2 6.3 mm jack socket for **AF out Unbalanced** audio output for channel 1
 - See [Outputting audio signals](#)
- 3 6.3 mm jack socket for **AF out Unbalanced** audio output for channel 2
 - See [Outputting audio signals](#)
- 4 XLR-3 socket for **AF out Balanced** audio output for channel 2
 - See [Outputting audio signals](#)
- 5 XLR-3 socket for **AF out Balanced** audio output for channel 1
 - See [Outputting audio signals](#)
- 6 BNC sockets **ANT 1 RF in** and **ANT 2 RF in** for antenna inputs
 - See [Connecting antennas](#)
- 7 Strain relief for the connection cable of the power supply unit
 - See [Connecting/disconnecting the receiver to/from the power supply system](#)
- 8 **DC in** connection socket for the power supply unit
 - See [Connecting/disconnecting the receiver to/from the power supply system](#)



Connecting/disconnecting the receiver to/from the power supply system

You can operate the receiver using either the included power supply unit or with Power over Ethernet (PoE IEEE 802.3af Class 0). Please refer to the following information.

Power from the power supply unit

- i** If using a power supply unit, use only the power supply unit included with the device. It is designed for your receiver and ensures safe operation.

- i** You will find the power supply unit and the country adapters in the packaging under the tray:

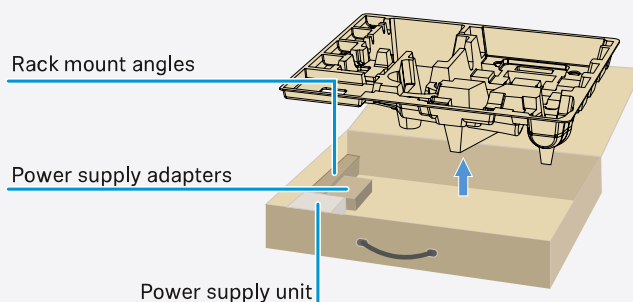

To connect the receiver to the power supply system:

- ▷ Insert the plug of the power supply unit into the **DC in** socket on the receiver.
- ▷ Pass the cable of the power supply unit through the strain relief.



- ▷ Slide the supplied country adapter onto the power supply unit.
- ▷ Plug the power supply unit into the wall socket.

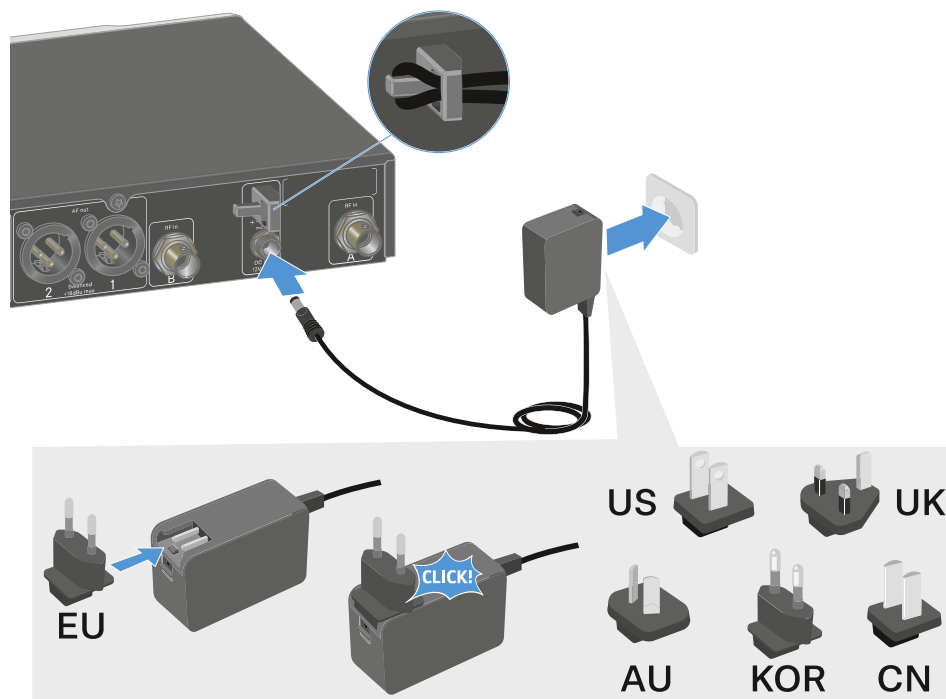

To completely disconnect the receiver from the power supply system:

- ▷ Unplug the power supply unit from the wall socket.
- ▷ Unplug the power supply unit from the **DC in** socket on the receiver.



Power over Ethernet (PoE)

- i** The receiver can be powered via **Power over Ethernet** (PoE IEEE 802.3af Class 0).

▷ Connect the receiver to a **PoE-enabled** network switch.

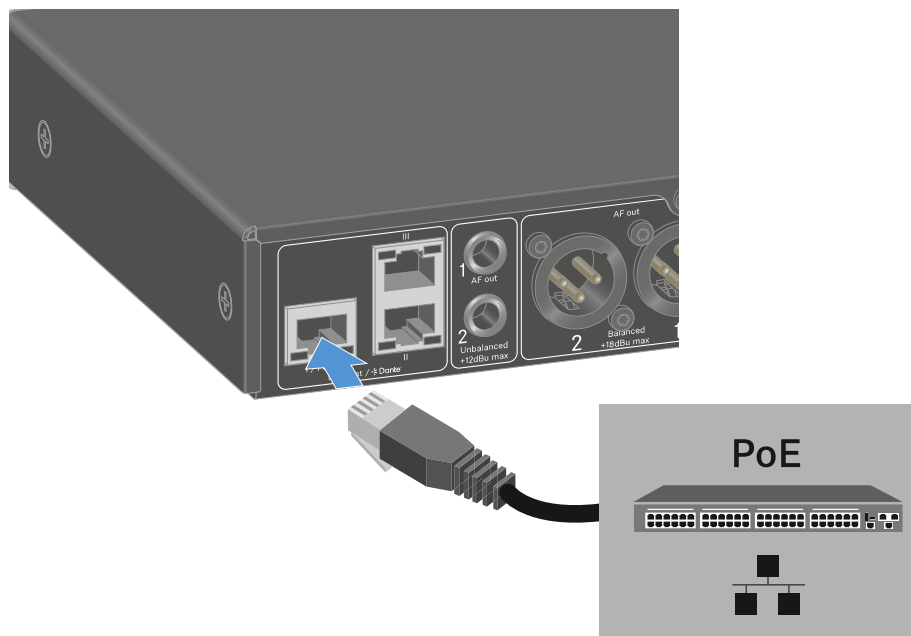

- i** Note the different assignments of the sockets (see [Connecting receivers in a network](#)).



Connecting receivers in a network

You can monitor and control one or more receivers via a network connection using the **Sennheiser Wireless Systems Manager (WSM)** or **Sennheiser Control Cockpit (SCC)** software.

- i** The network does not have to be a homogeneous network including only receivers. You can integrate the receiver into your existing network infrastructure with any other types of devices.

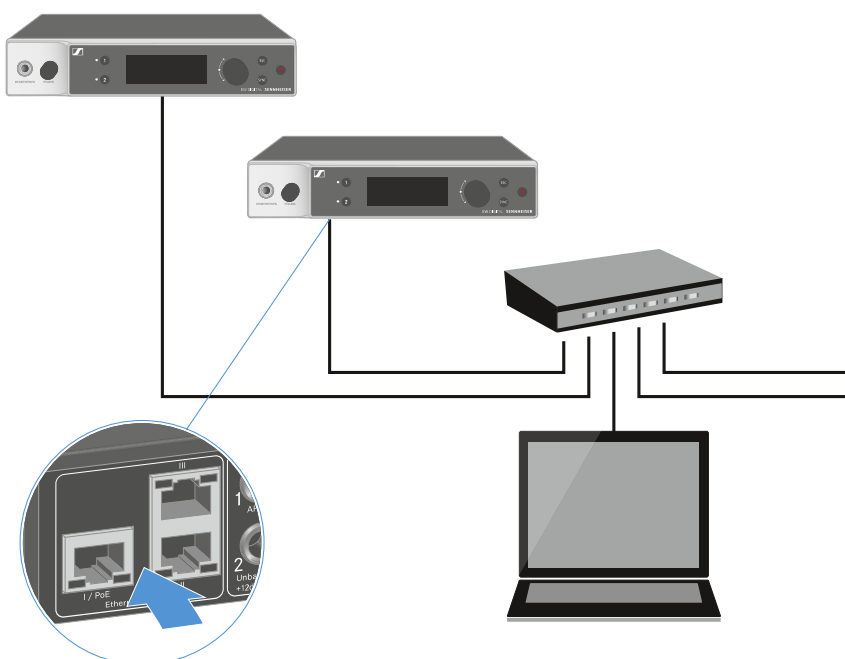

- i** For more information about controlling devices via the Sennheiser Wireless Systems Manager or Sennheiser Control Cockpit software, refer to the instruction manual for the software. You can download the software here:

sennheiser.com/wsm

sennheiser.com/control-cockpit-software



Connecting receivers in a Dante® network

Assignment of the network connections

The network connections have a different assignment depending on the network mode set.

The network mode can be changed in the **Network** menu, see [System -> Network menu item](#).

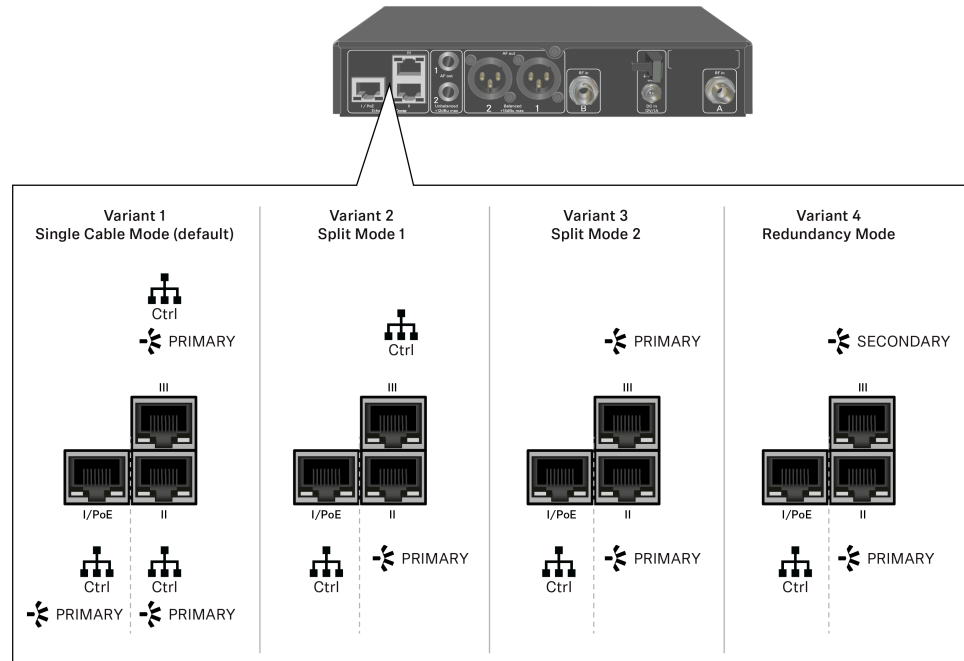

i PoE = Power over Ethernet

Ctrl = network control via e.g. Wireless Systems Manager (WSM), Sennheiser Control Cockpit (SCC) or third-party media control

PRIMARY = Dante® primary

SECONDARY = Dante® secondary

Related information

[Information](#)

[Connections and network settings](#)



Information

The EW-DX EM 2 Dante and EW-DX EM 4 Dante receivers are equipped with a versatile network interface with selectable network modes for flexible signal transmission. Further information is available on the following pages.

In compact network systems that only have a limited number of receivers, the “Single Cable” mode is the best option. This straightforward setup simplifies the installation and reduces the cabling workload.

For larger, more extensive network configurations, the “Split or Redundancy Mode” is recommended. In these operating modes, the differing control data can be wired separately alongside the digital audio protocol data and also allow for redundant cabling.

When integrating several switches in a network, it is important to carefully consider the possible effects on the network performance. A selected operating mode can, if the cabling is faulty, restrict the network operation or lead to system failure. In this respect, it is also important to ensure that the network switches from the respective manufacturers that are used also support the data and audio protocols (e.g. Dante) and that they have been configured accordingly.

Detailed instructions can be obtained from the respective manufacturers of the individual software applications.

- ▷ First of all, set the network mode in the receiver, see EW-DX EM 2 Dante [System -> Network menu item](#) and EW-DX EM 4 Dante [System -> Network menu item](#).
- ▷ Note the assignment of the sockets and the wiring examples on the following pages.

i The following examples do not show all of the cabling options.

- ▷ Connect the cables.

i Information about the Dante Controller and the Dante network protocol settings is available on the Audinate website: audinate.com

i Information on the use of remote software is available in the download area of the Sennheiser website: sennheiser.com/download



Connections and network settings

Single cable mode

Factory setting

— Network control / Dante primary

— Dante primary

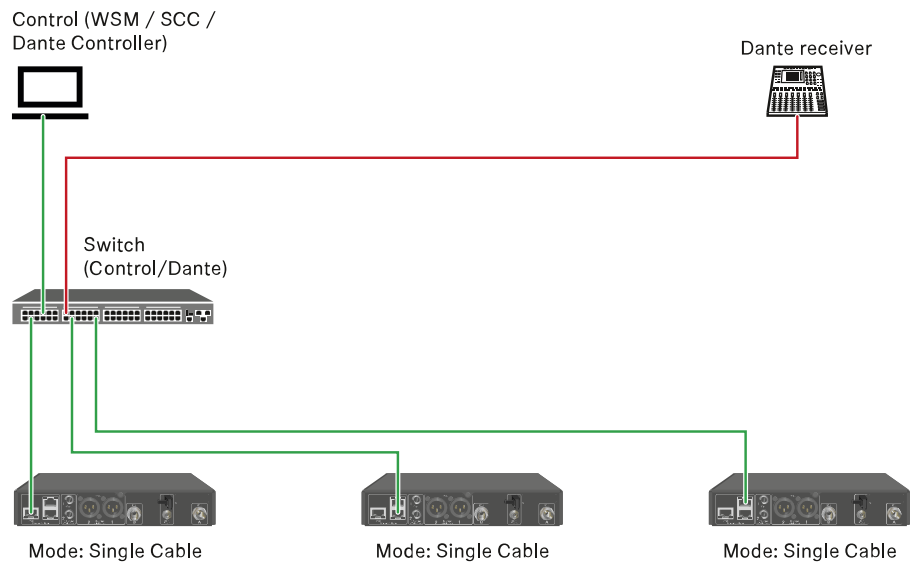

i The cable can be connected to network connections I, II or III.

Daisy-chain

— Network control / Dante

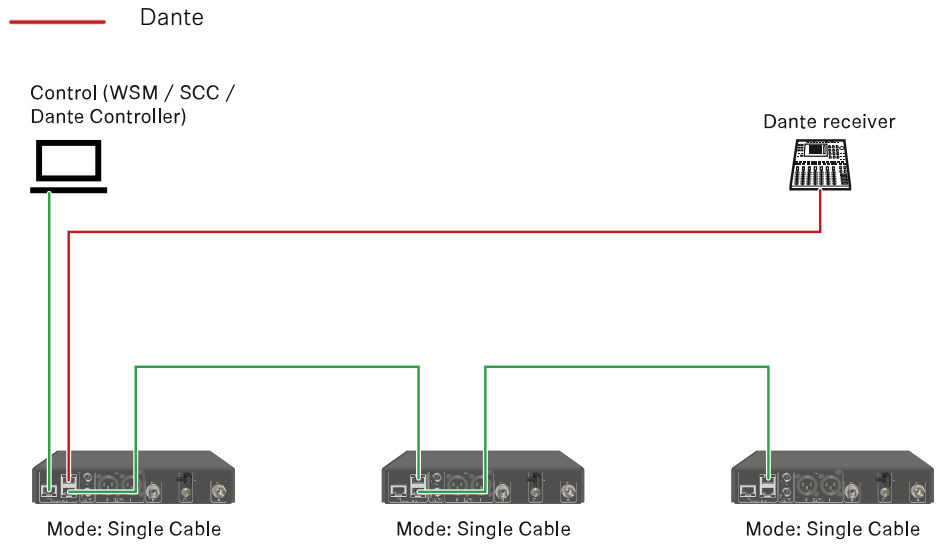

Split mode 1

Split 1 without daisy-chain

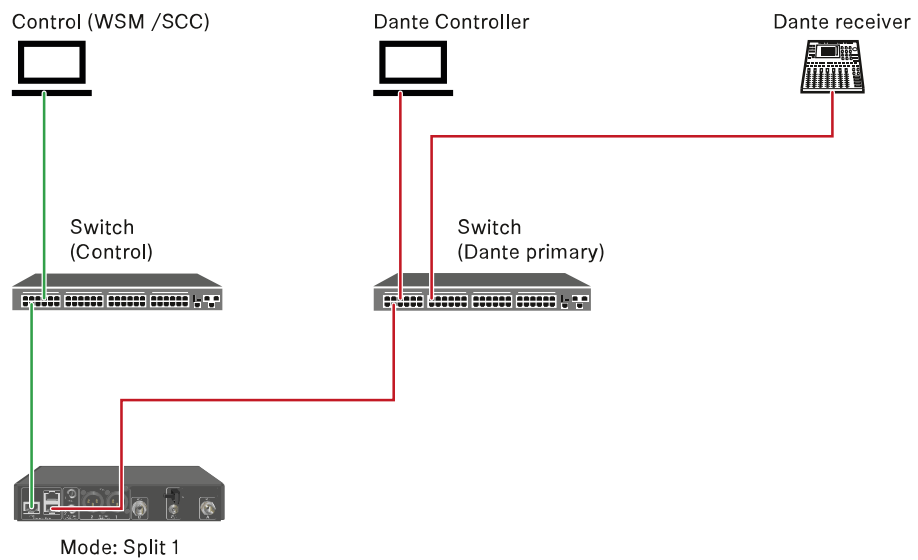
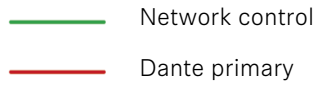

Split 1 with daisy-chain



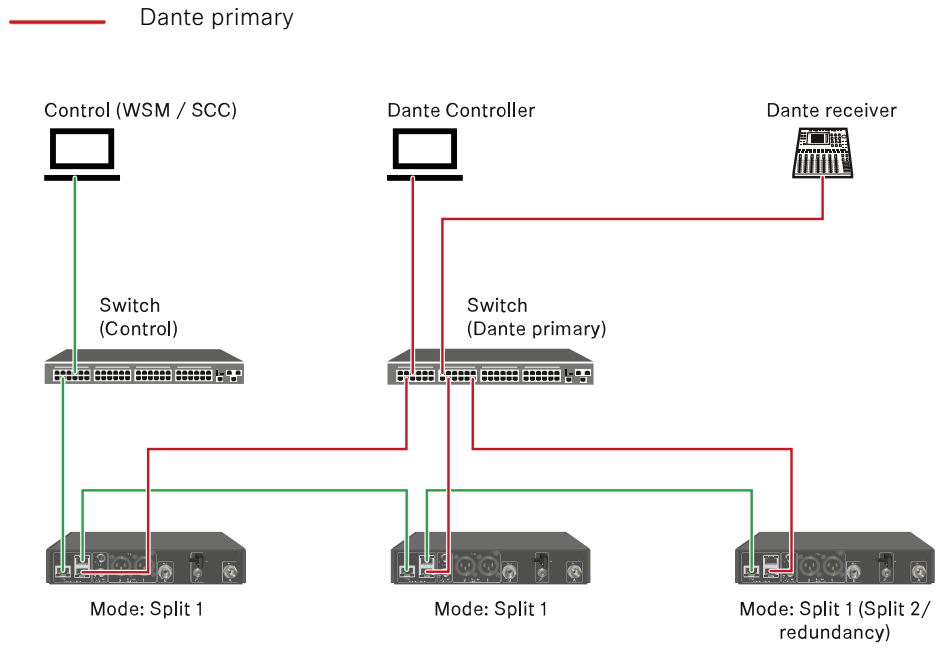

Split mode 2

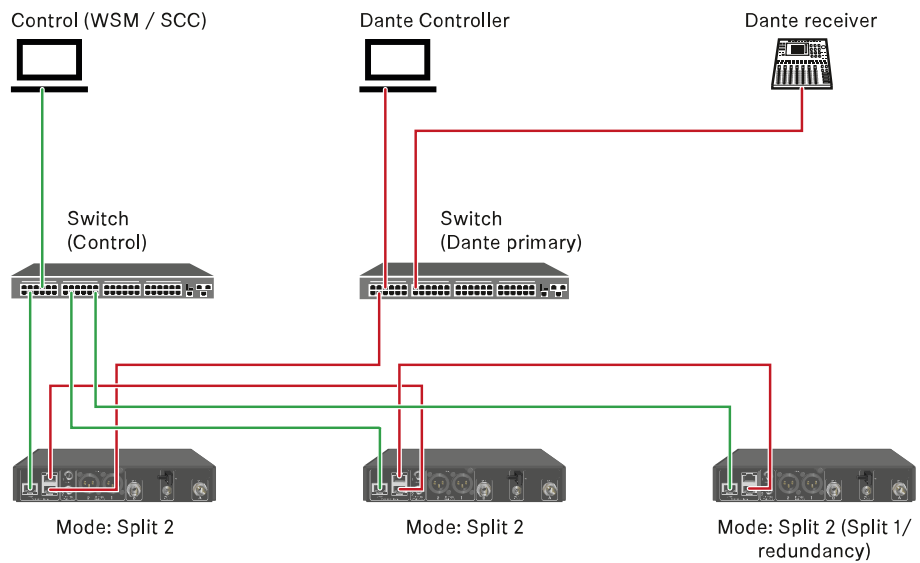
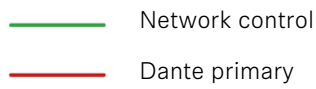

Redundancy mode





— Dante primary
— Dante secondary

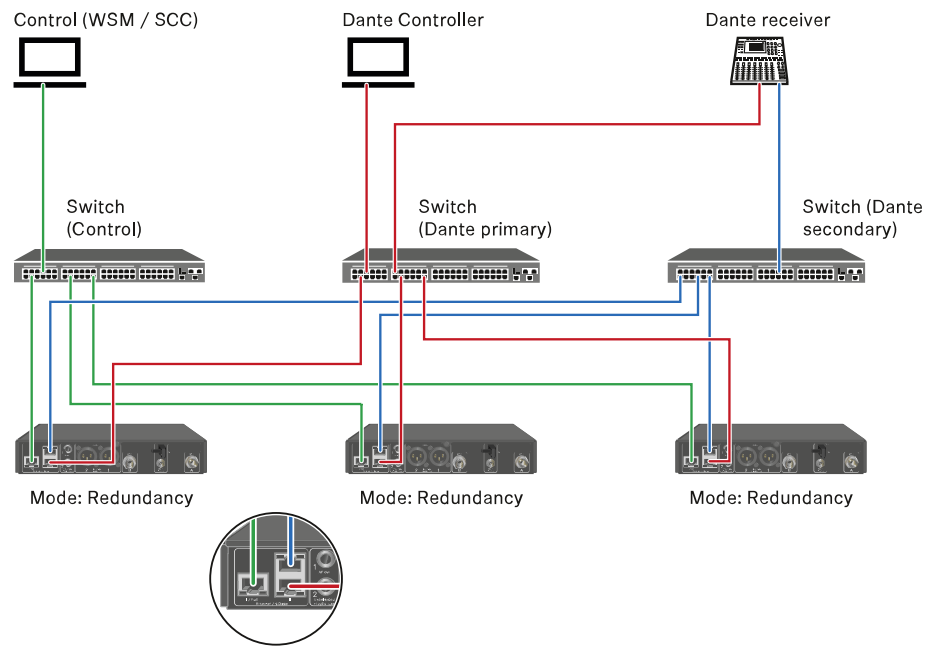



Connecting antennas

To connect the supplied rod antennas:

- ▷ Connect the antennas to the two antenna inputs on the receiver as shown in the figure.
- ▷ Slightly angle the antennas to the left and right as shown in the figure.

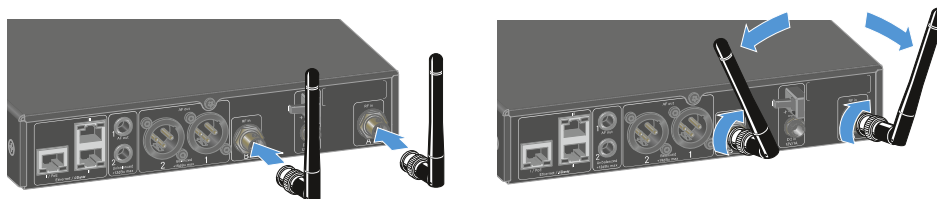

If you are using more than one receiver, we recommend using remote antennas and possibly the EW-D ASA antenna splitter ([EW-D ASA antenna splitter](#)).

To connect remote antennas:

- ▷ Connect the antennas to the two antenna inputs on the receiver as shown in the figure.

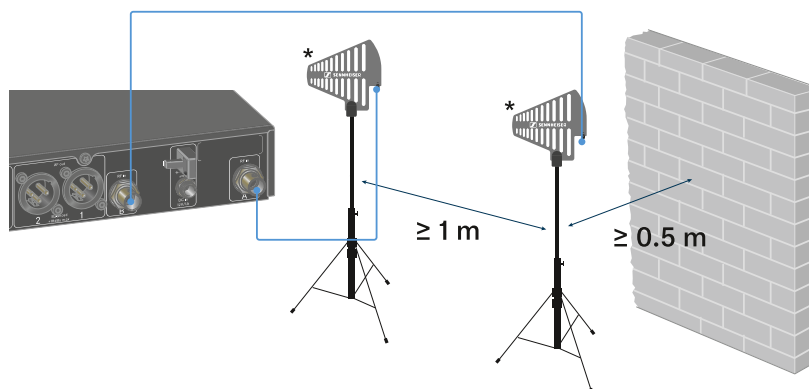

- ▷ Observe the specified minimum spacing.



▷ Observe the specified minimum spacing to the transmitters.

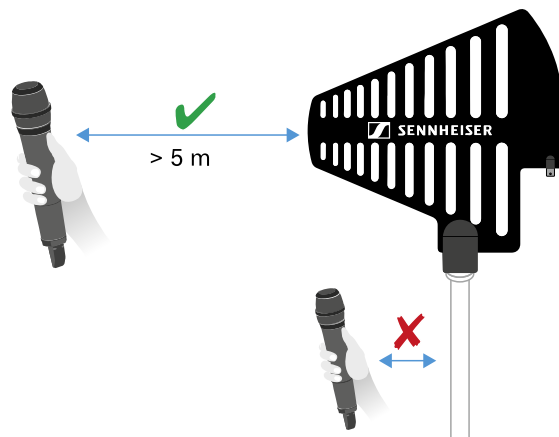

***Recommended antennas:**

- **ADP UHF** | 470 – 1075 MHz
- **AD 1800** | 1400 – 2400 MHz
- **AWM UHF I** | 470 – 694 MHz
- **AWM UHF II** | 823 – 1075 MHz
- **AWM 1G8** | 1785 – 1805 MHz

i If you are using more than one receiver, we recommend using remote antennas and possibly the [EW-D ASA antenna splitter](#) ([EW-D ASA antenna splitter](#)).



Outputting audio signals

Each of the two channels on the EW-DX EM 2 Dante has both a balanced XLR-3M output socket and an unbalanced 6.3 mm (1/4") jack output socket.

- ▷ Always use only one of the two output sockets for each channel.

To connect an XLR cable:

- ▷ Plug the XLR cable into the **AF out Balanced** socket for the respective channel on the EW-DX EM 2 Dante.

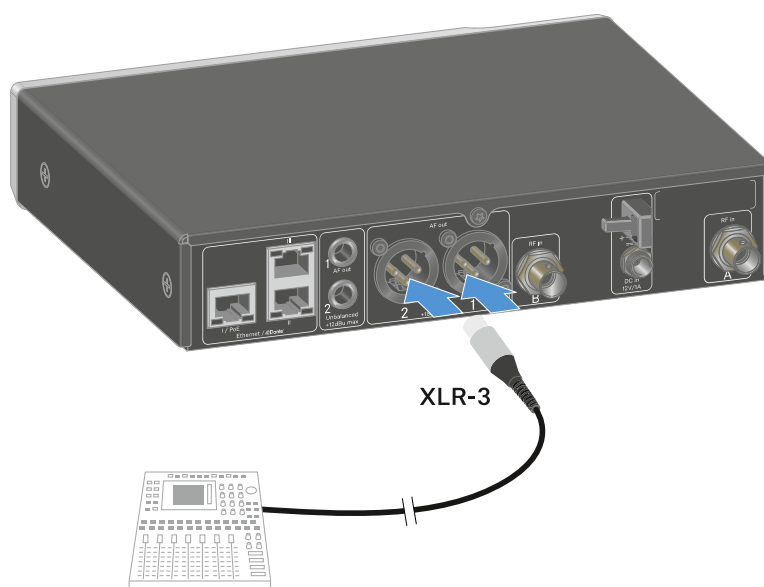



To connect a jack cable:

- ▷ Plug the jack cable into the **AF out Unbalanced** socket for the respective channel on the EW-DX EM 2 Dante.

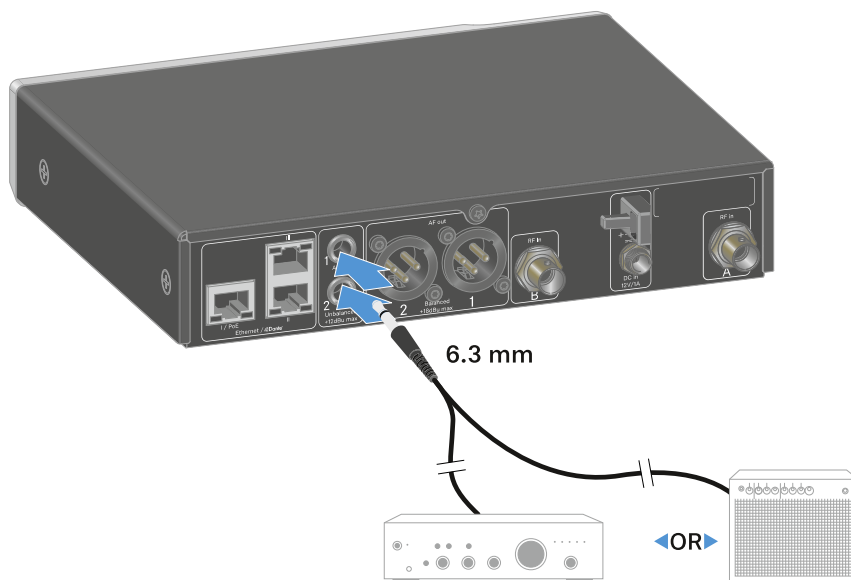

To output an audio signal via Dante:

- ▷ Connect the receiver as described under [Connecting receivers in a network](#).



Installing receivers in a rack

Observe the following instructions when mounting the receiver in a rack.

- i** The mounting brackets for installing the receiver in the rack can be found in the packaging under the tray:

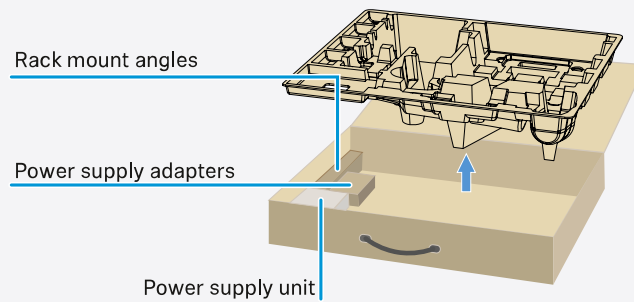

NOTICE



Rack mounting poses risks!

When installing the device in a closed 19" rack or multi-rack assembly, please consider that, during operation, the ambient temperature, the mechanical load and the electrical potentials will be different from those of devices which are not mounted into a rack.

- ▷ Make sure that the ambient temperature within the rack does not exceed the permissible temperature limit stated in the specifications. See [Specifications](#).
- ▷ Ensure sufficient ventilation; if necessary, provide additional ventilation.
- ▷ Make sure that the mechanical load of the rack is even.
- ▷ When connecting to the power supply system, observe the information indicated on the type plate. Avoid overloading the circuits. If necessary, provide overcurrent protection.
- ▷ When mounting in a rack, please note that intrinsically harmless leakage currents of the individual power supply units may accumulate, thereby exceeding the permissible limit value. As a remedy, ground the rack via an additional ground connection.



Mounting a single receiver in a rack

- ▷ Connect the mounting brackets to the sides of the receiver as shown.

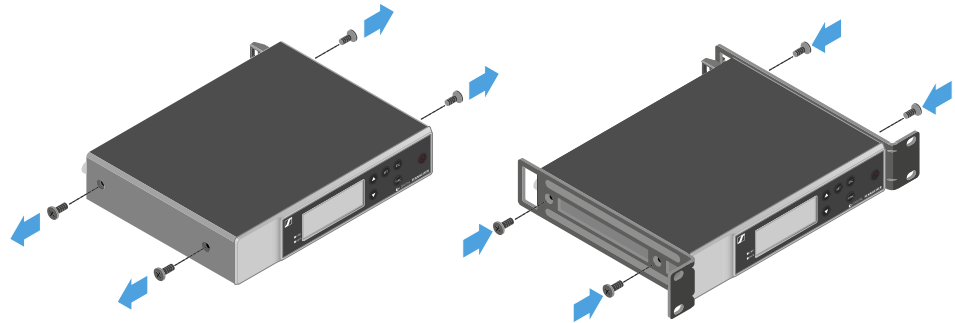

- ▷ Attach the front panel as shown.
- ▷ If desired, attach the antennas to the front panel as shown. This requires the optional AM 2 antenna front mount kit (see [Accessories for rack mounting](#)).

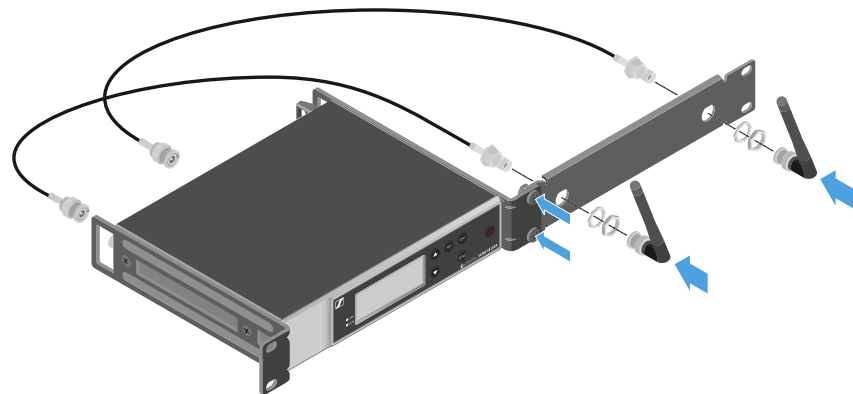



Mounting two receivers side by side in a rack

- ▷ Place both receivers upside down and side by side on an even surface.
- ▷ Tighten the jointing plate as shown.
- ▷ Attach the mounting brackets as shown.

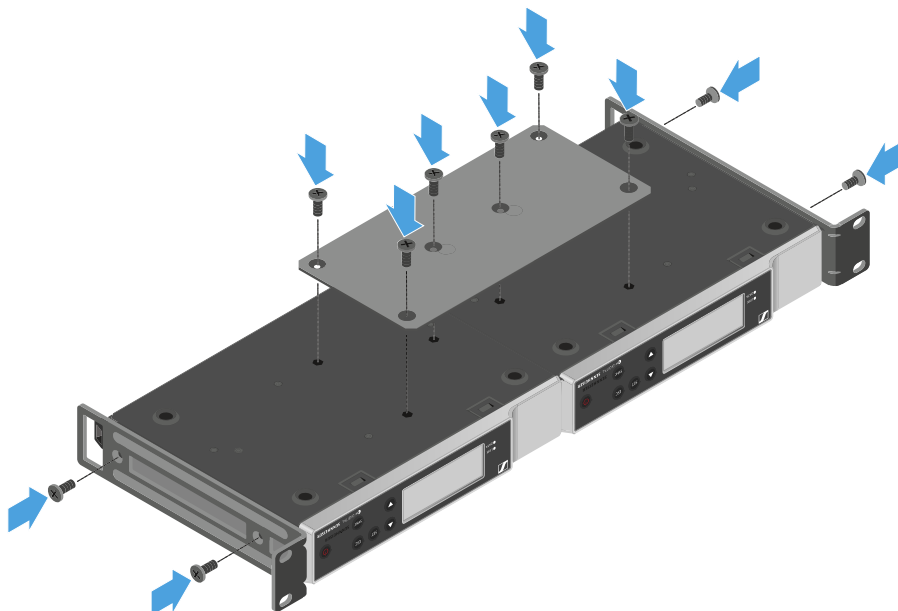



Switching the receiver on and off

To switch the receiver on:

- ▷ Short-press the **ON/OFF** button.
 - ➡ The receiver switches on.

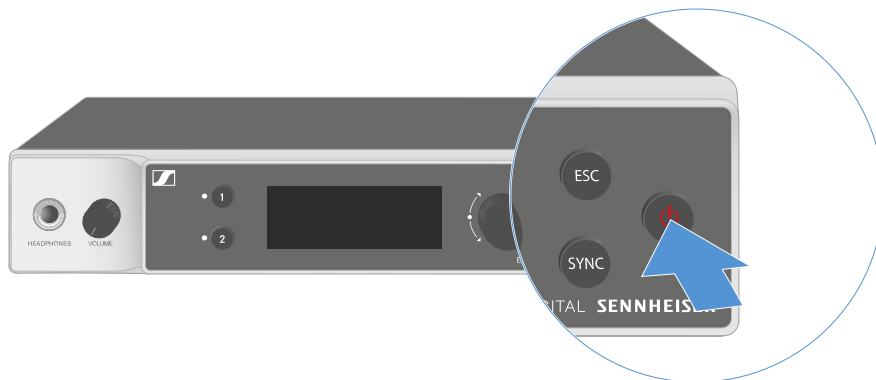

To switch the receiver to standby mode:

- ▷ If necessary, deactivate the lock-off function (see [Lock-off function](#)).
- ▷ Hold down the **ON/OFF** button until the display switches off.

To switch the receiver off completely:

- ▷ Disconnect the receiver from the power supply system by unplugging the power supply unit from the wall socket or disconnecting the PoE connection.



Lock-off function

You can enable or disable the automatic lock-off function in the **This Device** -> **Device Lock** menu item (see [System](#) -> [This Device menu item](#)).

To temporarily deactivate the lock-off function:

- ▷ Press the **jog dial**.
 - ➔ **Locked** appears in the display panel.
- ▷ Turn the **jog dial**.
 - ➔ **Unlock?** appears in the display panel.
- ▷ Press the **jog dial**.
 - ➔ Lock-off function is now temporarily deactivated.

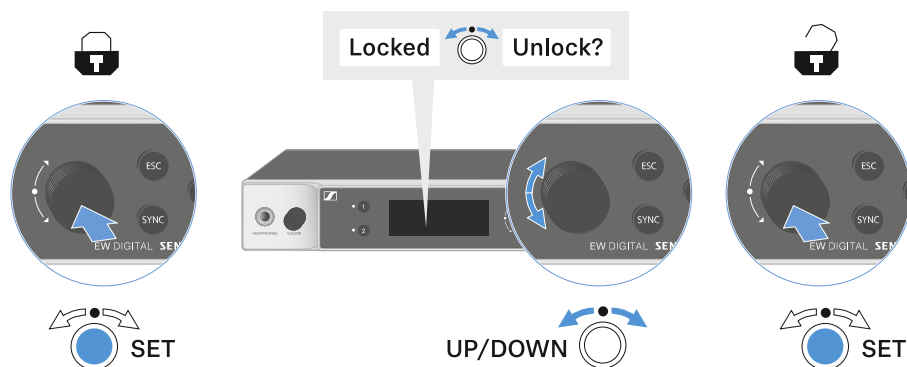

- ✓ The lock-off function remains deactivated while you are actively working in the operating menu.

i After 10 seconds of inactivity, it automatically activates again.



Using the headphone output

You can use the headphone output on the front of the receiver (6.3 mm jack) to listen to the audio signals of the two channels.

⚠ CAUTION



Danger due to high volume levels

Volume levels that are too high may damage your hearing.

- ▷ Turn down the volume of the headphone output before you put on the headphone.

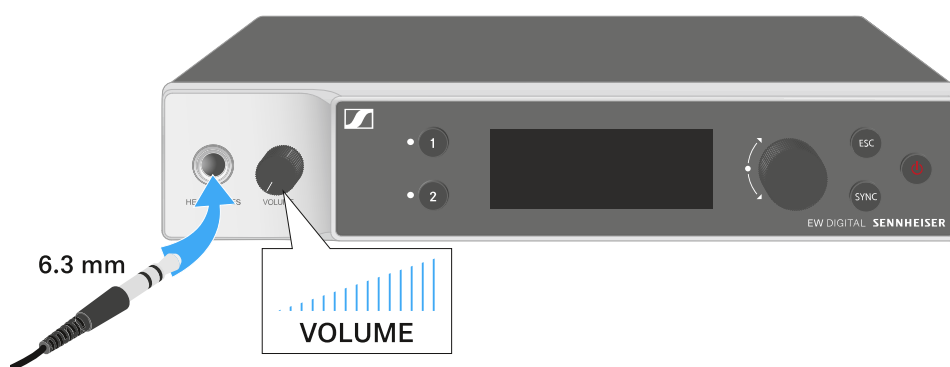

- ▷ Connect the headphone to the headphone output.
- ▷ Press the **CH 1** or **CH 2** button to listen to the audio signal from channel 1 or channel 2.
 - ➔ The headphone icon on the display indicates which channel is currently active on the headphone output. By default, the signal from channel 1 is active on the headphone output.
- ▷ You can control the volume by turning the volume knob next to the headphone output.



Meaning of the LEDs

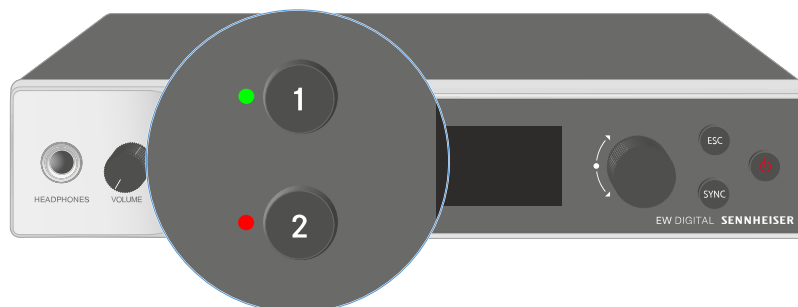

The two LEDs on the front of the receiver indicate the following information for channel 1 and channel 2.

The LED is green:



- The link between the transmitter and receiving channel is established.
- The audio signal is active.

The LED is yellow:



- The link between the transmitter and receiving channel is established.
- The audio signal is muted.



or

- No microphone module is mounted on the handheld transmitter.

The LED is flashing yellow:



- The link between the transmitter and receiving channel is established.
- The audio signal is overdriven (clipping).

The LED is continuously red:



- The link between the transmitter and receiving channel is established.
- The audio signal is overdriven (clipping).

The LED is flashing red:



- The link between the transmitter and receiving channel is established.
- The battery/rechargeable battery in the paired transmitter is low.

The LED is flashing blue:



- The **Bluetooth Low Energy** link is being established between the receiver and a smartphone or tablet with the **Smart Assist** app.

or

- The receiving channel is being synchronized with a transmitter.

The LED is blue:



- The firmware is being updated.
-



Displays on the receiver's display panel

Status information such as frequency, reception quality, battery status and audio level is shown on the display.

The display also shows the operating menu, which you can use to configure all of the settings (see [Buttons for navigating the menu](#)).

Home screen

The home screen is the default view on the display. The following information for both receiving channels is displayed here.

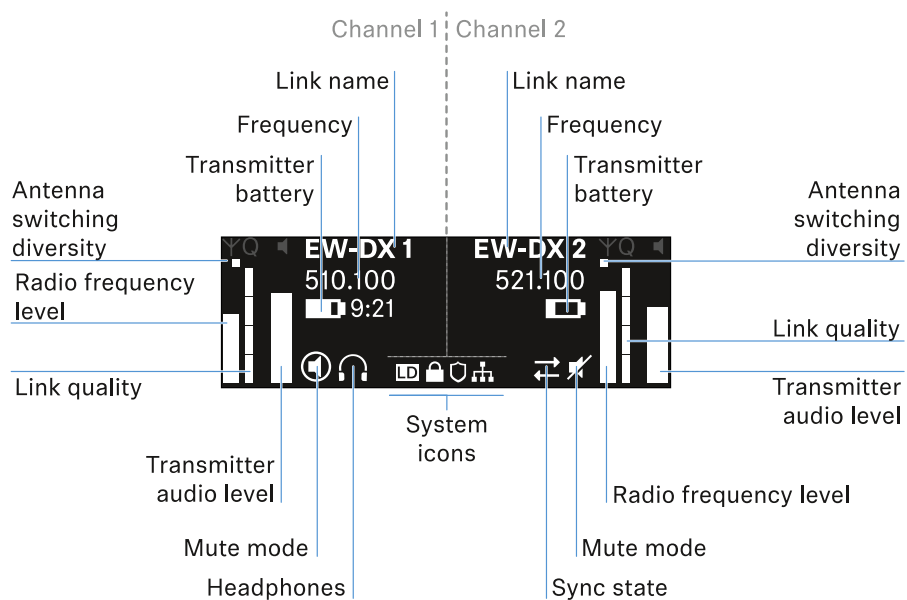

Antenna switching diversity:

Indicates which of the two antennas is currently active (left or right).

Signal level:

Displays the RF signal strength for the respective channel.

Link quality:

Displays the transmission quality for the respective channel.



i On the one hand, the transmission quality depends on the field strength (RF level indicator on the display). However, on the other hand, it also depends on external sources of interference that cannot be identified on the RF level indicator (for example, they may be on the same frequency or a very close neighboring frequency or may not affect the field strength).

As a basic principle, a value significantly higher than 50% should be achieved for a secure transmission.

Link name:

You can assign a name to the radio link in the receiver menu (see [Ch 1 / Ch 2 -> Name menu item](#)).

Frequency:

You can set the frequency of the radio link manually or using the Auto-Setup function.

- See [Ch 1 / Ch 2 -> Frequency menu item](#)
- See [Ch 1 / Ch 2 -> Scan / Auto Setup menu item](#)

Transmitter audio level:

Displays the audio input level for the respective channel (see [Ch 1 / Ch 2 -> Gain menu item](#)).

This level is separate from the audio level that is output from the receiver (see [Ch 1 / Ch 2 -> AF Out menu item](#)).

Transmitter battery:

Indicates the charging status of the transmitter's BA 70 rechargeable battery or batteries.

When using the BA 70 rechargeable battery, the remaining runtime is also displayed in hours and minutes.

Mute mode:



The mute switch is deactivated on the received transmitter.



The mute switch on the received transmitter is set to **AF Mute** and the audio signal is muted.

- [EW-DX SKM-S: Configuring mute mode and muting the handheld transmitter \(EW-DX SKM-S only\)](#)
- [EW-DX SK: Configuring mute mode and muting the bodypack transmitter](#)

Headphones:



The headphones icon indicates which channel is currently active on the headphone output (see [Using the headphone output](#)).

Sync state:



This icon indicates that different values are set for the receiving channel of the receiver and the transmitter. These values can be synchronized (see [Connecting to the EW-DX EM receivers / synchronizing the EW-DX EM](#)).

System icons:



The LD icon is displayed when Link Density mode is activated. See [System -> Link Density menu item](#).



The lock icon is displayed when the Auto Lock function is enabled. See [Lock-off function](#).



The network icon appears when a network connection is successfully established. See [Connecting receivers in a network](#).



The shield icon is displayed when AES 256 encryption is enabled. See [System -> Encryption menu item](#).

Related information

[Home screens 2 and 3](#)

[Channel 1](#)

[Channel 2](#)

[Meaning of the Link Quality Indicator](#)

Home screens 2 and 3

- ▷ Turn the **jog dial** on the home screen to the right.
 - ➔ The second home screen appears with network information for the device.
- ▷ Turn the **jog dial** to the right again.
 - ➔ The third home screen appears with information about the software and hardware.

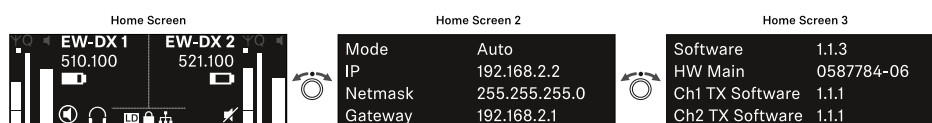



Channel 1

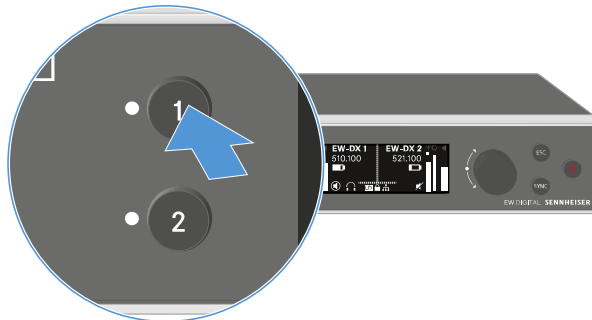

- ▷ On the receiver's home screen, press the **CH 1** button.
- ➔ The home screen for channel 1 appears.

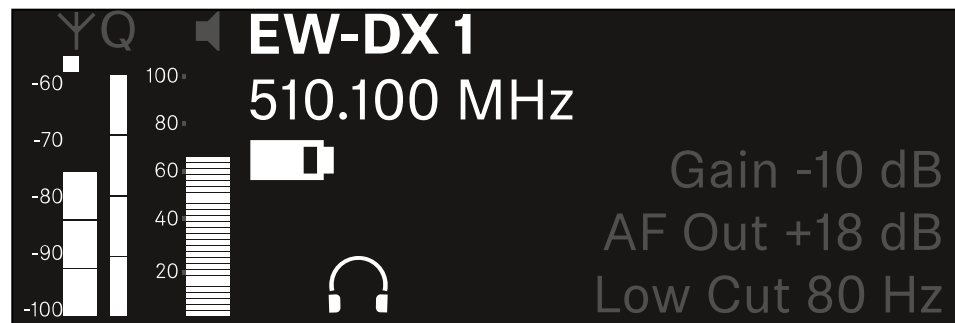

In addition to the status information displayed on the home screen, information about the channel's audio settings is also displayed.

- ▷ Turn the **jog dial** to the right to view more information about the received transmitter.

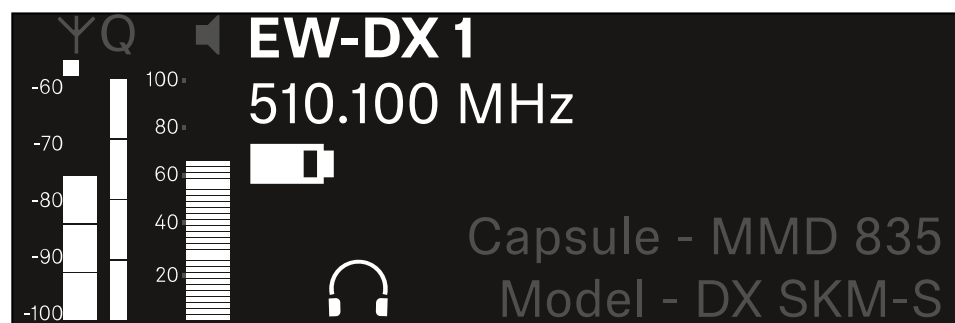



- ▷ Turn the **jog dial** further to the right to mute or unmute the channel's audio signal.

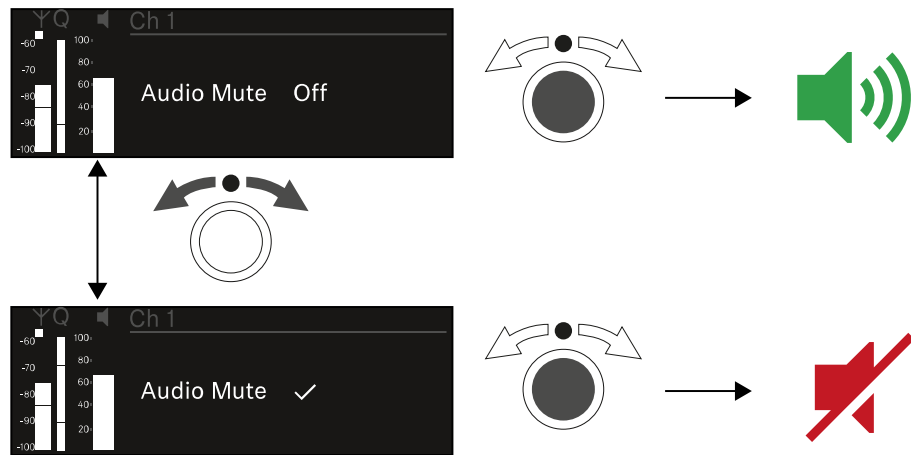

- ▷ Press the **jog dial** to confirm your selection.



Channel 2

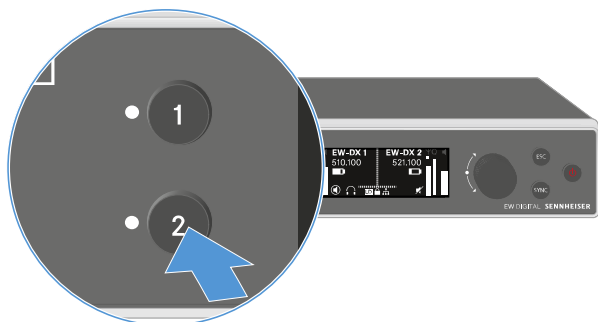

- ▷ On the receiver's home screen, press the **CH 2** button.
 - ➔ The home screen for channel 2 appears.

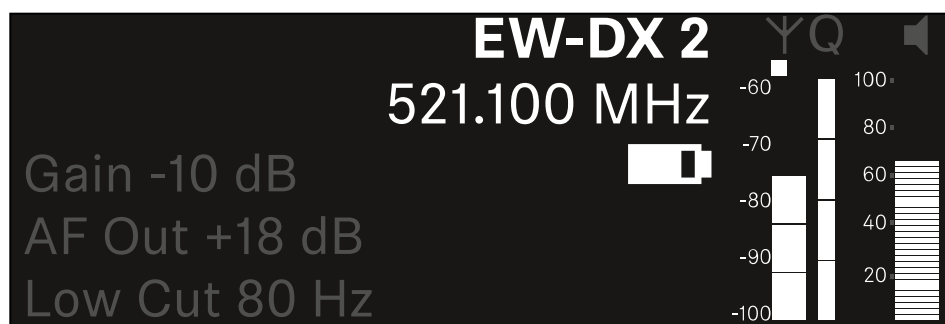

You can view and configure the same information as for channel 1, see [Channel 1](#).



Meaning of the Link Quality Indicator

The **LQI** (Link Quality Indicator) on the display of the receiver shows the transmission quality for the respective channel.

On the one hand, the transmission quality depends on the field strength (**RF** indicator on the receiving channel display). However, on the other hand, it also depends on external sources of interference that cannot be identified on the **RF** indicator (for example, they may be on the same frequency or a very close neighboring frequency or may not affect the RF strength).

As a basic principle, an LQI value significantly higher than 50% should be achieved for a secure transmission.

The LQI display shows the following information:

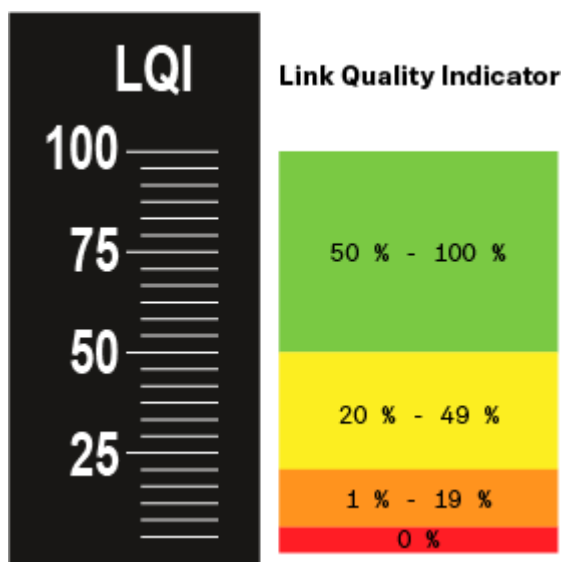

Green range from 50% to 100%:

- No transmission errors

The transmission quality is good enough to ensure an audio quality of 100%.

Yellow range from 20% to 49%:

- Individual transmission errors: short-term error correction active
- Individual audio artifacts may be audible

There are initial transmission errors. In rare cases, there are initial audible audio artifacts. Error correction may be active in this case.



Orange range from 1% to 19%:

- Frequent transmission errors: long-term error correction active
- Risk of audio drop-outs

The transmission errors increase, which means that the error correction duration also increases. There is a risk of audio drop-outs.

Red range 0%:

- No transmission

In this range, the transmission quality is so poor that audio drop-outs can no longer be avoided.



Buttons for navigating the menu

Use the following buttons to navigate through the receiver's operating menu.

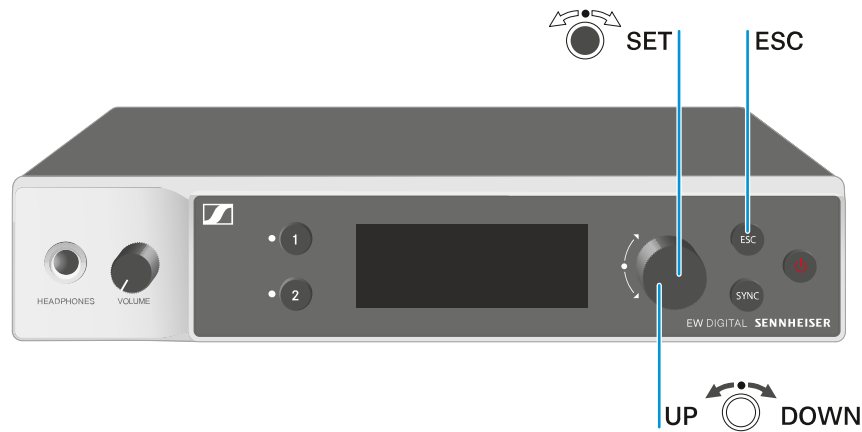

Press the **jog dial**

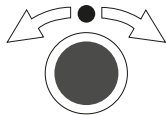

- Jumps from the home screen to the operating menu
- Calls up a menu item
- Changes to a submenu
- Saves settings

Turn the **jog dial**

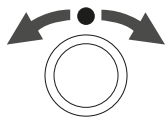

- Selects a standard display (see [Displays on the receiver's display panel](#))
- Changes to the previous or next menu item
- Changes the setting of a menu item

Press the **ESC** button



- Cancels the entry and returns to the previous display

i [Opening the menu and navigating the menu items](#)



Opening the menu and navigating the menu items

To open the menu:

- ▷ Press the **jog dial** when you are on the **home screen**.

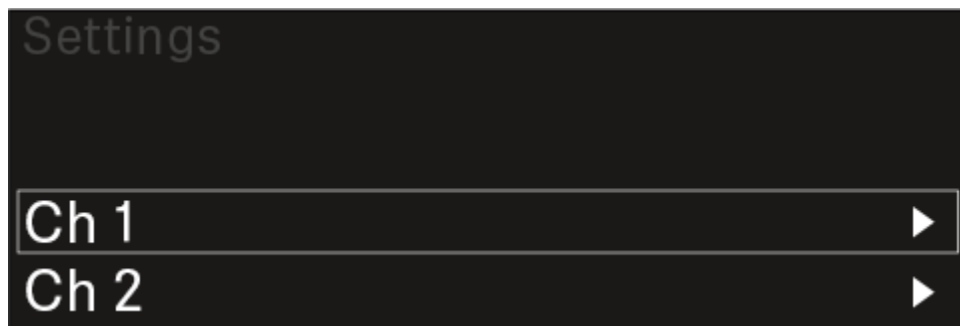

- ▷ Turn the **jog dial** to navigate to your desired menu item.
- ▷ Press the **jog dial** to open the selected menu item.

To exit the menu:

- ▷ Press the **ESC** button to exit the menu and return to the **home screen**.
 - ➡ Changes that were not previously saved by pressing the **jog dial** will be lost.

Related information

[Menu structure](#)

[Setting options in the menu](#)

[System menu item](#)



Menu structure

The figure shows the complete menu structure in an overview.

Version: firmware 3.0.0

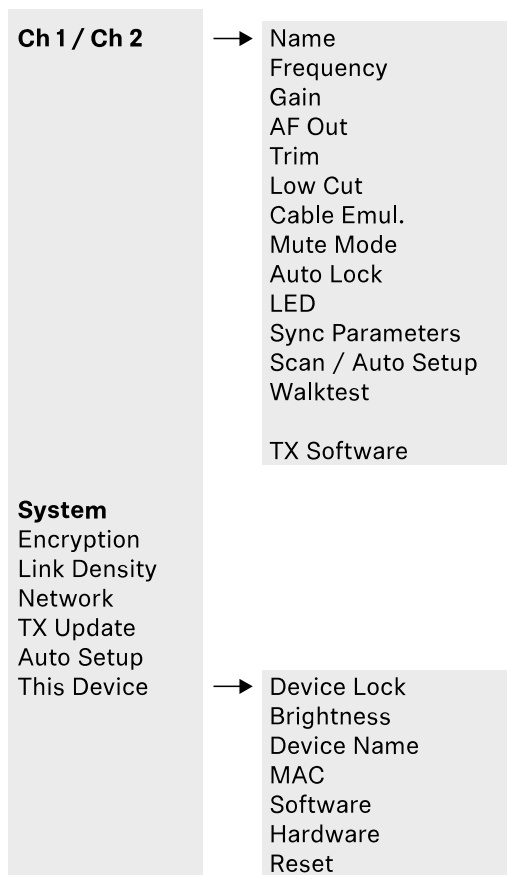



Setting options in the menu

In the receiver menu, you can configure the following settings.

Changing the name of the radio link

- [Ch 1 / Ch 2 -> Name menu item](#)

Adjusting frequencies

- [Ch 1 / Ch 2 -> Frequency menu item](#)

Adjusting the gain of the wireless link

- [Ch 1 / Ch 2 -> Gain menu item](#)

Setting the output level of the audio signal

- [Ch 1 / Ch 2 -> AF Out menu item](#)

Adjusting the trim of the connected transmitter

- [Ch 1 / Ch 2 -> Trim menu item](#)

Adjusting the low-cut filter

- [Ch 1 / Ch 2 -> Low Cut menu item](#)

Configuring cable emulation for the bodypack transmitter

- [Ch 1 / Ch 2 -> Cable Emul. menu item](#)

Setting the function of the transmitter's mute switch

- [Ch 1 / Ch 2 -> Mute Mode menu item](#)

Enabling the transmitter's automatic lock-off function

- [Ch 1 / Ch 2 -> Auto Lock menu item](#)

Configuring the behavior of the transmitter's LEDs

- [Ch 1 / Ch 2 -> LED menu item](#)

Activating/deactivating the parameters to be synchronized on the transmitters

- [Ch 1 / Ch 2 -> Sync Parameters menu item](#)



Performing a frequency scan and automatic frequency setup

- [Ch 1 / Ch 2 -> Scan / Auto Setup menu item](#)

Check the reception quality within the operating environment

- [Ch 1 / Ch 2 -> Walktest menu item](#)

Viewing the software version of the connected transmitters

- [Ch 1 / Ch 2 -> TX Software menu item](#)

Configuring different system settings

- Enabling AES 256 encryption
- Setting transmission mode
- Configuring network settings
- Updating the firmware for the transmitters
- Activating the Auto Setup function
- Changing device names
- [System menu item](#)

i You can find an overview of the entire menu structure under [Menu structure](#).

Ch 1 / Ch 2 -> Name menu item

In the **Name** menu item, you can define the name of the link for the channel in question.

i This name is the name of the radio link between the transmitter and receiving channel. You can set the name of the receiver as it will appear in a network from the **This Device** menu in the system menu. See [System -> This Device menu item](#).



To open the Name menu item:

- ▷ In the menu, navigate to the **Name** menu item for the desired channel.

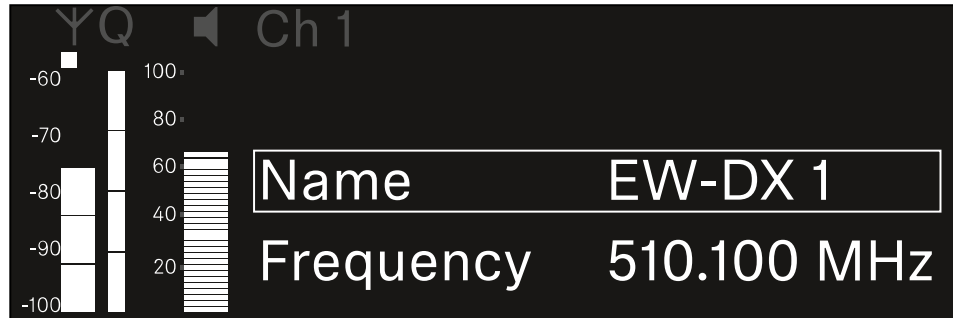

- ▷ Press the **jog dial** to open the menu.

➔ The following view is displayed:

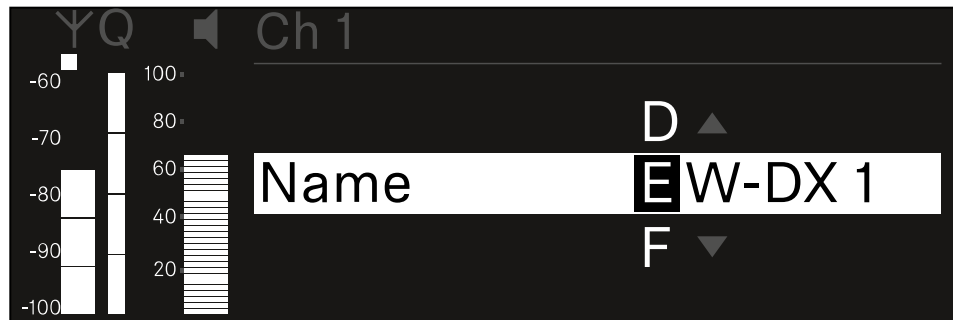

To enter the desired link name:

- ▷ Turn the **jog dial** to select the desired character.
 - ▷ Press the **jog dial** to go to the next position.
 - ▷ At the last position, press the **jog dial** to save the selected name.
- Or
- ▷ Press the **ESC** button to cancel the entry without saving the settings.

i For the chosen link name to appear on the display of the received transmitter, you must synchronize the channel ([Connecting to the EW-DX EM receivers / synchronizing the EW-DX EM](#)).



Ch 1 / Ch 2 -> Frequency menu item

In the **Frequency** menu item, you can adjust the frequency for the channel in question.

You can select a frequency from the predefined list or set the frequency manually.

To open the Frequency menu item:

- ▷ In the menu, navigate to the **Frequency** menu item for the desired channel.

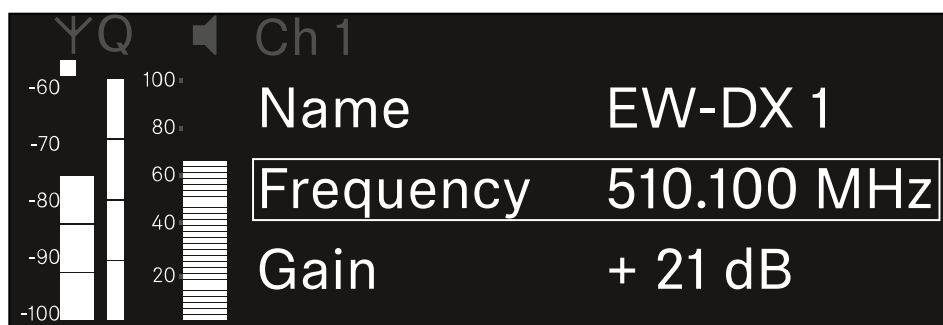

- ▷ Press the **jog dial** to open the menu.

➔ The following view is displayed:

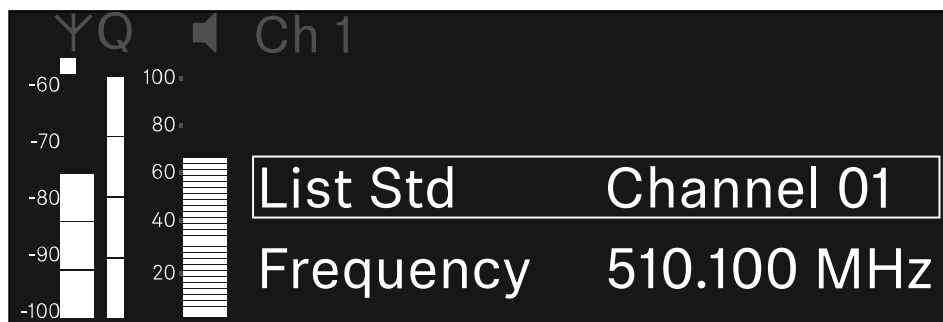

- ▷ Rotate the **jog dial** to select between the **List** and **Frequency** subitems.

➔ The **List** subitem allows you to select a frequency from the predefined list. The **Frequency** subitem lets you set the desired frequency manually.



To select a frequency from a predefined list:

- ▷ Open the **List** subitem.

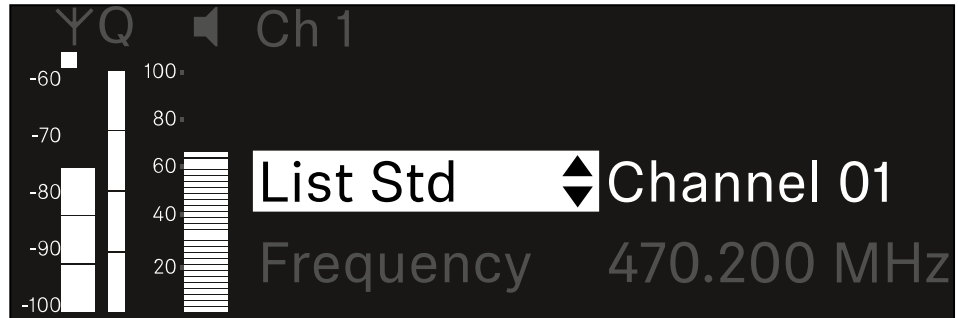

- ▷ Rotate the **jog dial** to choose between the predefined list (**List Std**) and the user-defined list (**List Usr**).

i You can create a custom list using the **Wireless Systems Manager** (WSM) software and upload it to the receiver. For more information on the **WSM** software, see:

sennheiser.com/wsm

- ▷ Press the **jog dial** to confirm your selection.

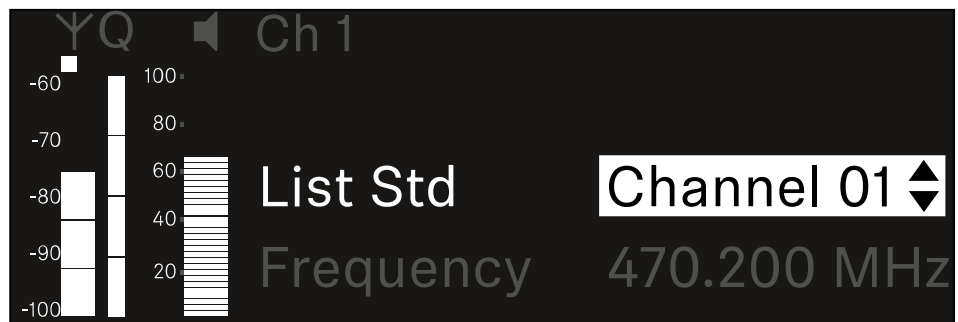

- ▷ Rotate the **jog dial** to select the desired channel from the list.
 - ➔ The frequency assigned to the channel is displayed.
- ▷ Press the **jog dial** to save the selected channel.
 - Or
- ▷ Press the **ESC** button to cancel the entry without saving the settings.



To set the frequency manually:

- ▷ Open the **Frequency** subitem.

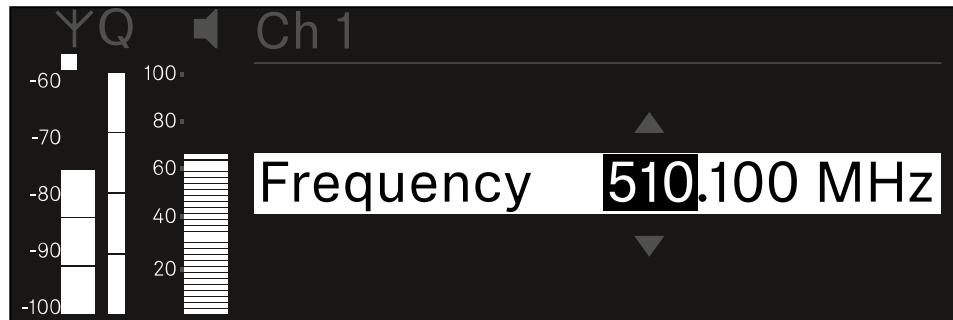

- ▷ Turn the **jog dial** to set the MHz range for the frequency.
- ▷ Press the **jog dial** to confirm your selection.

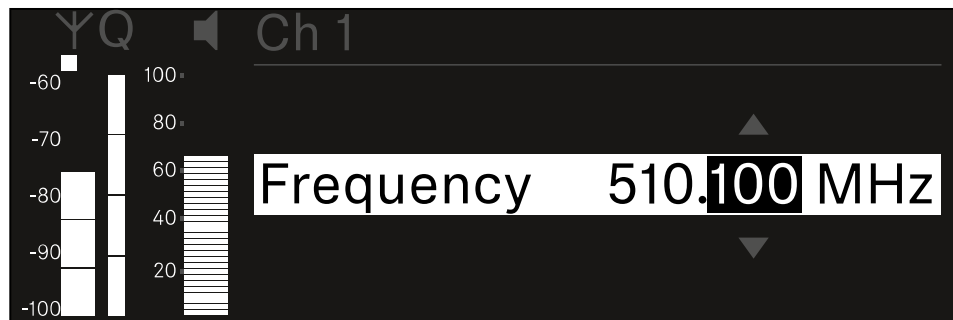

- ▷ Turn the **jog dial** to set the kHz range for the frequency.
- ▷ Press the **jog dial** to save your selected frequency.or
Or
- ▷ Press the **ESC** button to cancel the entry without saving the settings.



Ch 1 / Ch 2 -> Gain menu item

Under the **Gain** menu item, you can set the audio level of the audio signal coming from the received transmitter (e.g. vocals or speech via EW-DX SKM or guitar via EW-DX SK).

- Setting range: **-3 dB** to **+42 dB** in increments of 3 dB

To open the Gain menu item:

- ▷ In the menu, navigate to the **Gain** menu item for the desired channel.



- ▷ Press the **jog dial** to open the menu.
➔ The following view is displayed:

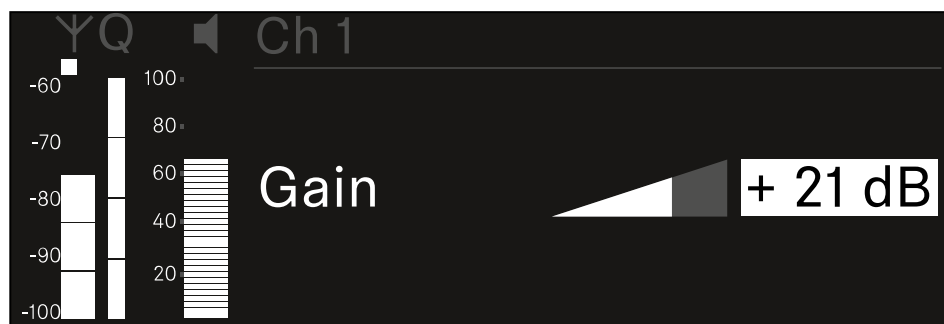

- ▷ Turn the **jog dial** to set the desired value.
- ▷ Press the **jog dial** to save your setting.
- Or
- ▷ Press the **ESC** button to cancel the entry without saving the settings.



Ch 1 / Ch 2 -> AF Out menu item

In the **AF Out** menu item, you can set the audio level that is output via the audio outputs of the particular receiving channel.

To open the **AF Out** menu item:

- ▷ In the menu, navigate to the **AF Out** menu item for the desired channel.



- ▷ Press the **jog dial** to open the menu.

➔ The following view is displayed:

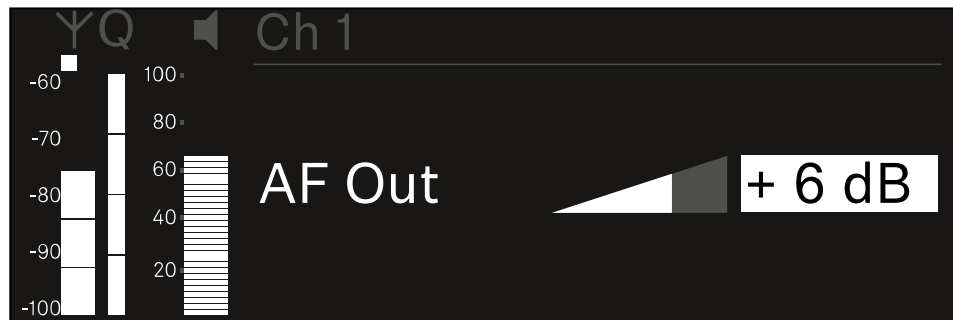

- ▷ Turn the **jog dial** to set the desired value.
- ▷ Press the **jog dial** to save your setting.
- Or
- ▷ Press the **ESC** button to cancel the entry without saving the settings.



Ch 1 / Ch 2 -> Trim menu item

In the **Trim** menu item, you can adjust the audio level of the received transmitter to input signals of different volumes.

- i** For example, if you are using multiple transmitters in alternation for a single receiving channel, you can adjust the transmitters to the different input signals using the trim setting. You do not need to change the channel's gain setting.

- Setting range: **-12 dB** to **+6 dB** in increments of 1 dB

To open the Trim menu item:

- ▷ In the menu, navigate to the **Trim** menu item for the desired channel.



- ▷ Press the **jog dial** to open the menu.

➔ The following view is displayed:

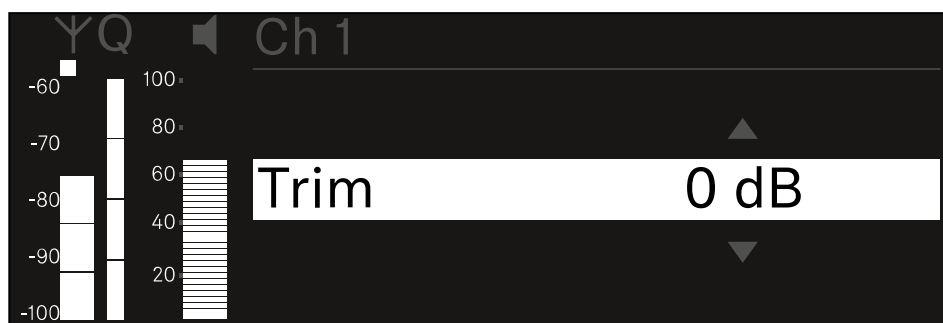

- ▷ Turn the **jog dial** to set the desired value.
- ▷ Press the **jog dial** to save your setting.
- Or
- ▷ Press the **ESC** button to cancel the entry without saving the settings.



- i** For the set value to be applied to the received transmitter, you must synchronize the channel ([Connecting to the EW-DX EM receivers / synchronizing the EW-DX EM](#)).



Ch 1 / Ch 2 -> Low Cut menu item

In the **Low Cut** menu item, you can set the value of the low cut filter for the respective channel.

Setting range:

- For **EW-DX SK | EW-DX SK 3-PIN**: Off, 30 Hz, 60 Hz, 80 Hz, 100 Hz, 120 Hz
- For **EW-DX SKM | EW-DX SKM-S**: 60 Hz, 80 Hz, 100 Hz, 120 Hz

To open the Low Cut menu item:

- ▷ In the menu, navigate to the **Low Cut** menu item for the desired channel.

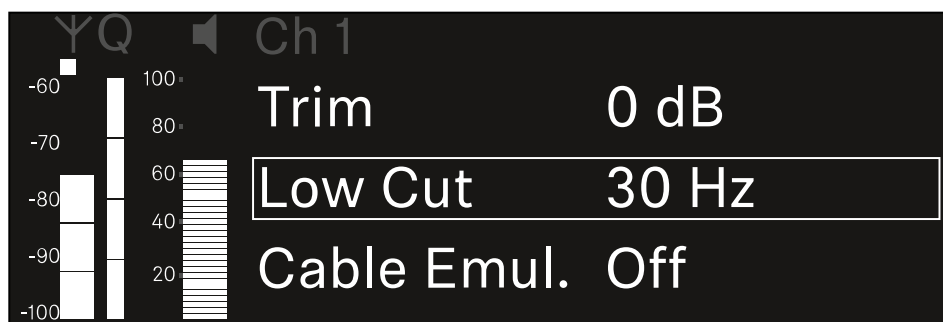

- ▷ Press the **jog dial** to open the menu.

➔ The following view is displayed:

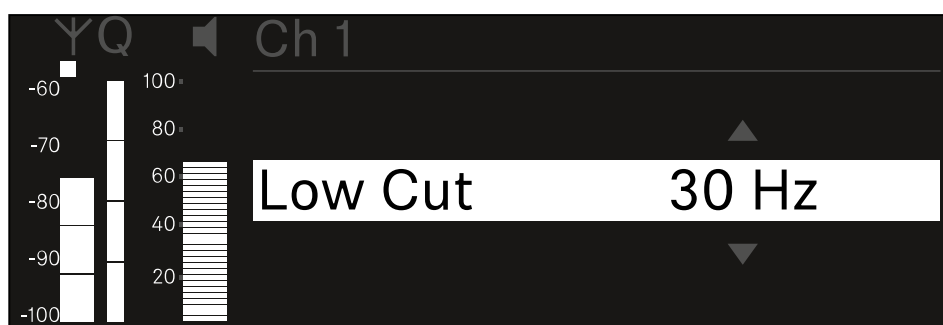

- ▷ Turn the **jog dial** to set the desired value.
- ▷ Press the **jog dial** to save your setting.
- Or
- ▷ Press the **ESC** button to cancel the entry without saving the settings.

i For the set value to be applied to the received transmitter, you must synchronize the channel ([Connecting to the EW-DX EM receivers / synchronizing the EW-DX EM](#)).



Ch 1 / Ch 2 -> Cable Emul. menu item

In the **Cable Emul.** menu item, you can emulate instrument cable lengths:

Setting range:

- Off, Type 1, Type 2, Type 3

To open the Cable Emul. menu item:

- ▷ In the menu, navigate to the **Cable Emul.** menu item for the desired channel.

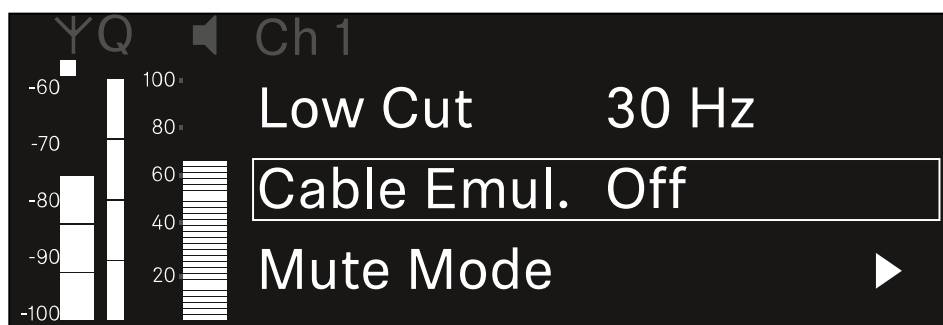

- ▷ Press the **jog dial** to open the menu.

➔ The following view is displayed:

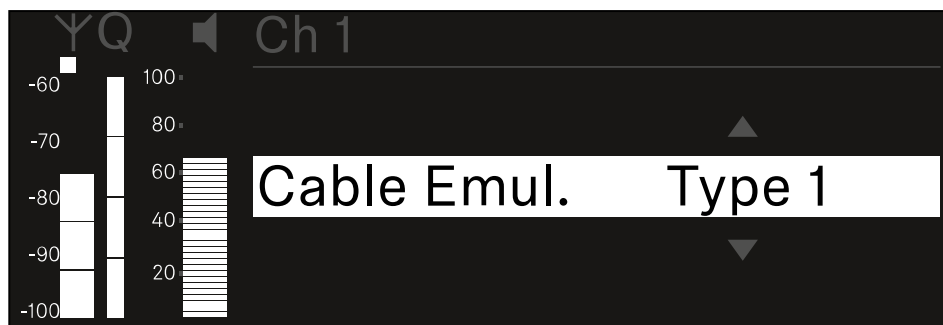

- ▷ Turn the **jog dial** to set the desired value.
- ▷ Press the **jog dial** to save your setting.
- Or
- ▷ Press the **ESC** button to cancel the entry without saving the settings.



Ch 1 / Ch 2 -> Mute Mode menu item

In the **Mute Mode** menu item, you can set the function of the mute switch on the connected transmitter (EW-DX SK, EW-DX SK 3-PIN, EW-DX SKM-S, EW-DX TS).

EW-DX SKM-S, EW-DX SK/EW-DX SK 3-PIN setting range:

- **Disabled:** The mute switch has no function.
- **RF Mute:** The RF signal is deactivated when the mute switch is on.
- **AF Mute:** The audio signal is muted when the mute switch is on.

EW-DX TS setting range:

- **Disabled:** The **MUTE** button has no function.
- **AF Mute:** The audio signal is muted when the **MUTE** button is pressed. Pressing the button again activates the audio signal.
- **PTT (Push to talk):** Press and hold the **MUTE** button to activate the audio signal.
- **PTM (Push to mute):** Press and hold the **MUTE** button to mute the audio signal.

To open the Mute Mode menu item:

- ▷ In the menu, navigate to the **Mute Mode** menu item for the desired channel.

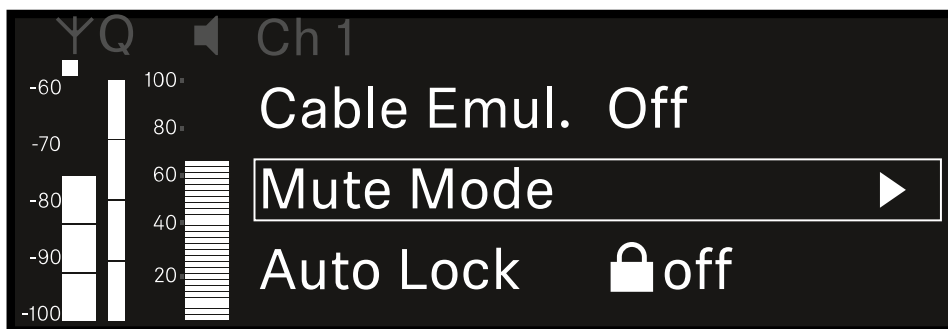

- ▷ Press the **jog dial** to open the menu.

➔ The following view is displayed:

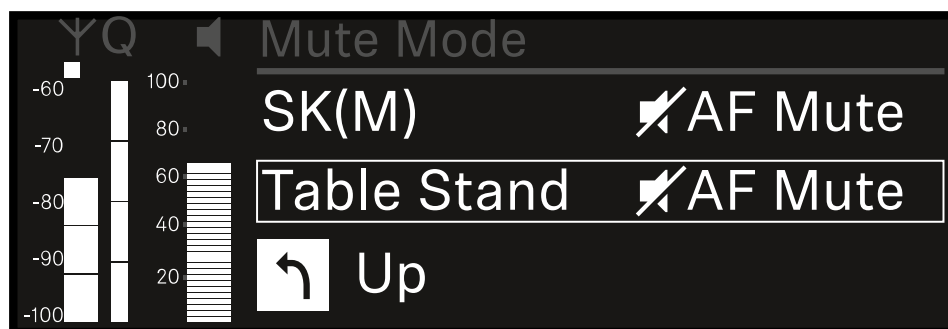



- ▷ Turn the **jog dial** to set the desired value.
- ▷ Press the **jog dial** to save your setting.
Or
- ▷ Press the **ESC** button to cancel the entry without saving the settings.

i For the set value to be applied to the received transmitter, you must synchronize the channel ([Connecting to the EW-DX EM receivers / synchronizing the EW-DX EM](#)).



Ch 1 / Ch 2 -> Auto Lock menu item

In the **Auto Lock** menu item, you can activate or deactivate the lock-off for the received transmitter.

The lock-off prevents the transmitter from being unintentionally switched off and also prevents any changes to the transmitter's menu.

i If you want to change settings in the transmitter's menu while the lock-off is active, you have to temporarily disable the lock-off:

- EW-DX SKM: [Lock-off function](#)
- EW-DX SK: [Lock-off function](#)

To open the **Auto Lock** menu item:

▷ In the menu, navigate to the **Auto Lock** menu item for the desired channel.

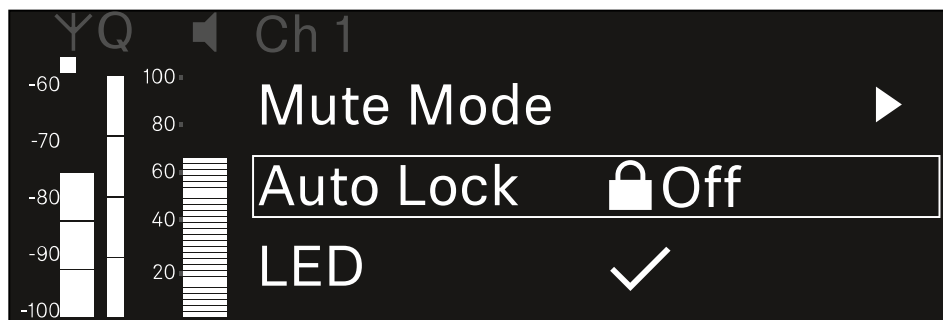

▷ Press the **jog dial** to open the menu.

➔ The following view is displayed:

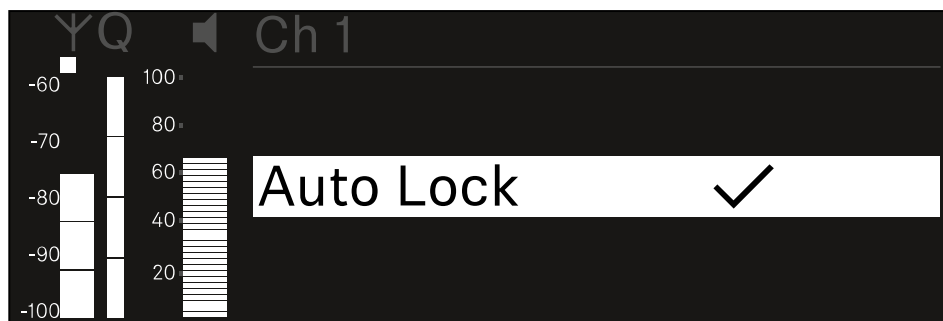

▷ Turn the **jog dial** to set the desired value.

▷ Press the **jog dial** to save your setting.

Or

▷ Press the **ESC** button to cancel the entry without saving the settings.



- i** For the set value to be applied to the received transmitter, you must synchronize the channel ([Connecting to the EW-DX EM receivers / synchronizing the EW-DX EM](#)).



Ch 1 / Ch 2 -> LED menu item

The **LED** menu item allows you to set the behavior of the LINK LED on the received transmitter.

Setting range:

- **ON:** The LINK LED remains continuously lit.
- **OFF:** The LINK LED switches off while the lock-off function is active.

i For this to occur, the automatic lock-off function must be enabled in the Auto Lock menu item (see [Ch 1 / Ch 2 -> Auto Lock menu item](#)).

To open the LED menu item:

- ▷ In the menu, navigate to the **LED** menu item for the desired channel.

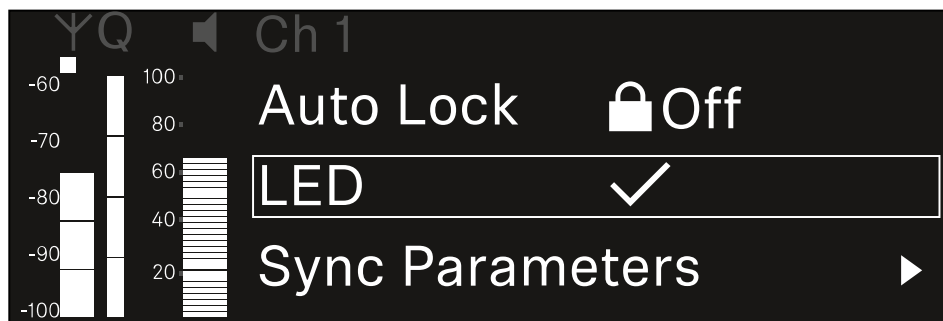

- ▷ Press the **jog dial** to open the menu.

➔ The following view is displayed:

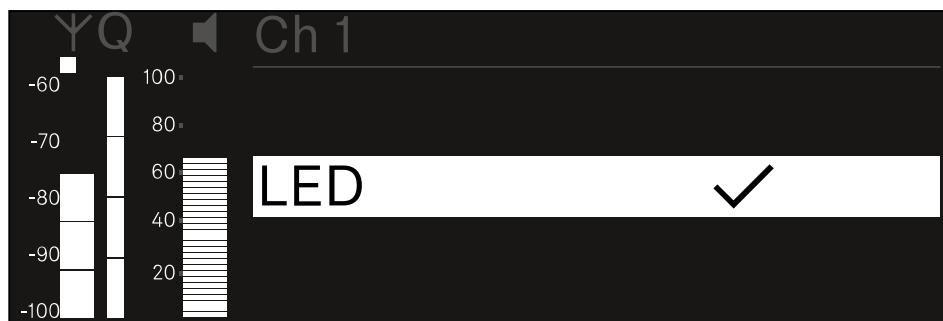

- ▷ Turn the **jog dial** to set the desired value.
- ▷ Press the **jog dial** to save your setting.
Or
- ▷ Press the **ESC** button to cancel the entry without saving the settings.



- i** For the set value to be applied to the received transmitter, you must synchronize the channel ([Connecting to the EW-DX EM receivers / synchronizing the EW-DX EM](#)).



Ch 1 / Ch 2 -> Sync Parameters menu item

In the **Sync Parameters** menu item, you can choose which settings for the transmitter you want to transfer from the receiver to the transmitter during the synchronization.

- i** All of the settings can also be set separately in the menu on the transmitter. During synchronization, the values set in the transmitter are overwritten with the values set in the receiver.

The following parameters can be enabled or disabled for transmission.

- Name
- Frequency
- Trim
- Low Cut
- Cable Emul.
- Mute Mode
- Auto Lock
- LED

To open the Sync Settings menu item:

- ▷ In the menu, navigate to the **Sync Settings** menu item for the desired channel.

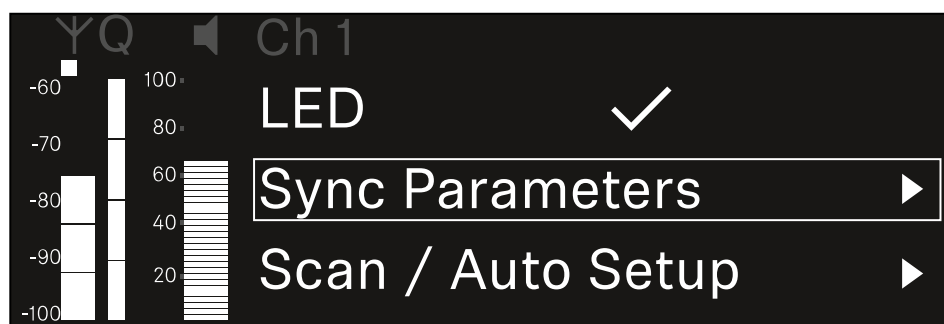

- ▷ Press the **jog dial** to open the menu.



➔ The following view is displayed:

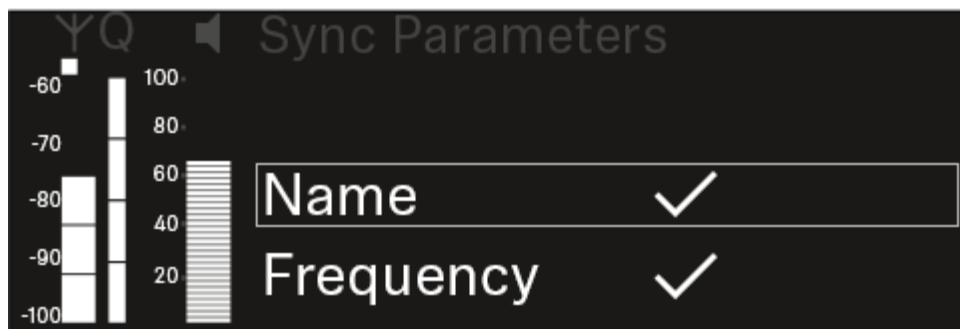

- ▷ Turn the **jog dial** to choose between the options.
- ▷ Press the **jog dial** to open your selected option.

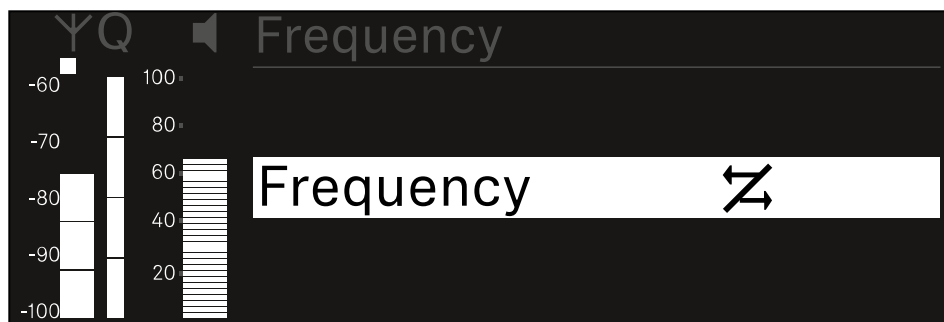
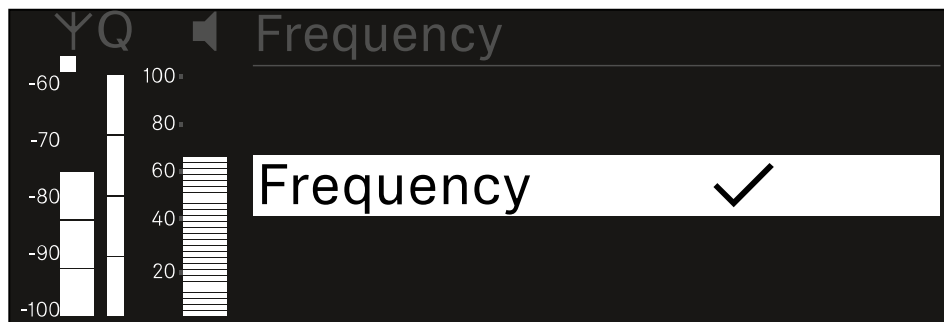

- ▷ For each option, select whether it will be synchronized or not.
 - ✓ The value set for this function will be transferred during synchronization.
 - ✗ The value set for this function will not be transferred during synchronization.

▷ Press the **jog dial** to save your setting.



Ch 1 / Ch 2 -> Scan / Auto Setup menu item

The receiver lets you scan the frequency spectrum and display all of the free frequencies in the selected frequency range. The automatic frequency setup can be used to distribute the free frequencies to all of the EW-DX EM 2 Dante devices available in the network automatically.

- ▷ Switch off all transmitters before you perform the scan.
 - ➔ If transmitters are still switched on, they are detected as unavailable frequencies and the frequencies that are actually available cannot then be used.

i To perform the automatic frequency setup for all devices in the network, the Auto Setup function must be enabled in the receiver's system menu: [System -> Auto Setup menu item](#)

i An EM that is performing one of the following actions will be excluded from the frequency setup of another EM:

- Remote (full) scan
- Scan Me / Scan Network -> Autosetup
- Bonding
- TX Sync
- TX Update
- Device Update (if in progress)

To open the Scan / Auto Setup menu item:

- ▷ In the menu, navigate to the **Scan / Auto Setup** menu item for the desired channel.

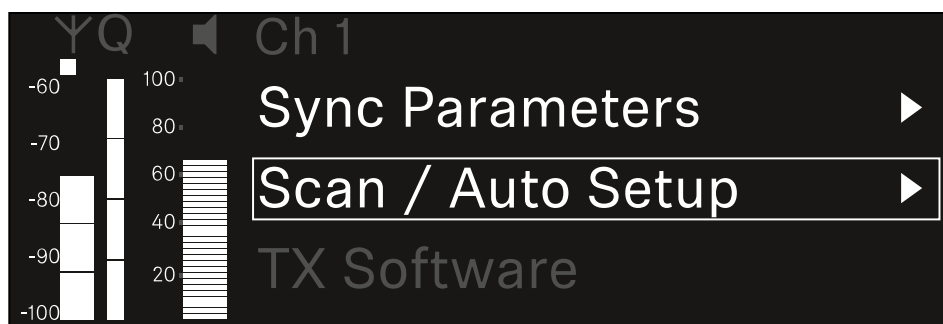

- ▷ Press the **jog dial** to open the menu.



➔ The following view is displayed:

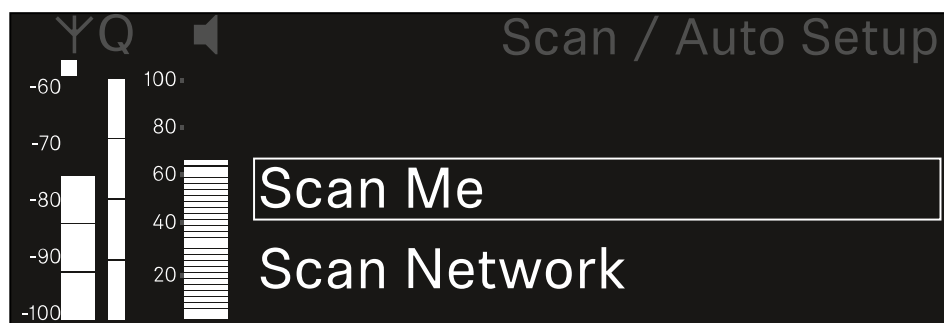

- ▷ Turn the **jog dial** to choose between the **Scan Me** and **Scan Network** options.
 - **Scan Me:** The frequency scan and the frequency setup are performed only for the selected receiving channel.
 - **Scan Network:** The frequency scan and the frequency setup are performed for both channels of the receiver as well as for all other receivers available in the network.
- ▷ Press the **jog dial** to open your selected option.

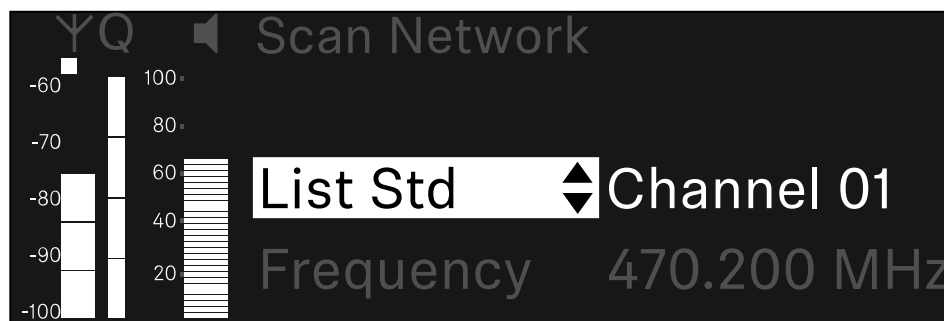

- ▷ Select a frequency from which to start the scan.
- ▷ Press the **jog dial** to start the scan.



➔ The spectrum is scanned for free frequencies above the selected frequency.

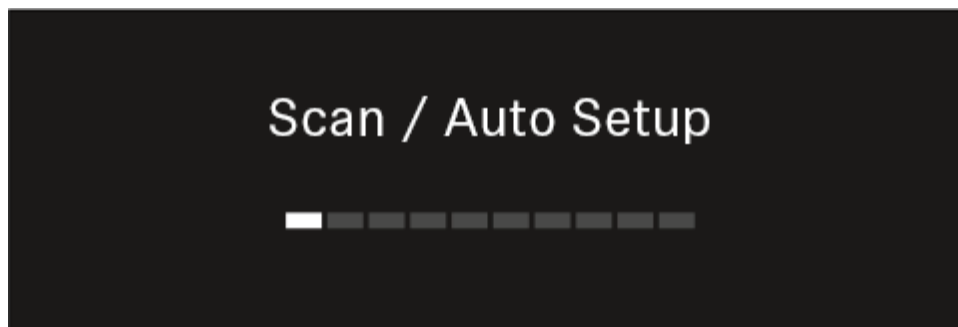

i After the scan free frequencies are displayed, which you can then assign to the channels.

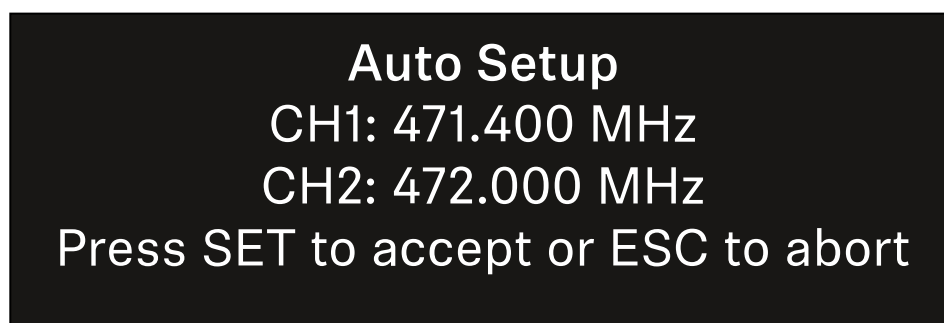

- ▷ Press the **jog dial** to assign the free frequencies to the receiving channels.
Or
- ▷ Press the **ESC** key to cancel and not assign new frequencies.
- ▷ Next, synchronize the receiving channels with the corresponding transmitters to establish the radio link at the new selected frequencies ([Synchronizing the receiver and transmitter](#)).



Ch 1 / Ch 2 -> Walktest menu item

The **Walktest** menu item allows the performance of a reception test.

Once you have set up and installed all of the receivers and transmitters for your event, we recommend performing a walk test. This lets you check whether sufficient reception strength is available throughout the entire area used.

Start the walktest function in this menu item and then walk the entire area with one transmitter. The results of the walk test give you information about the reception quality.

Opening the Walktest menu item

- ▷ In the menu, navigate to the **Walktest** menu item for the desired channel.

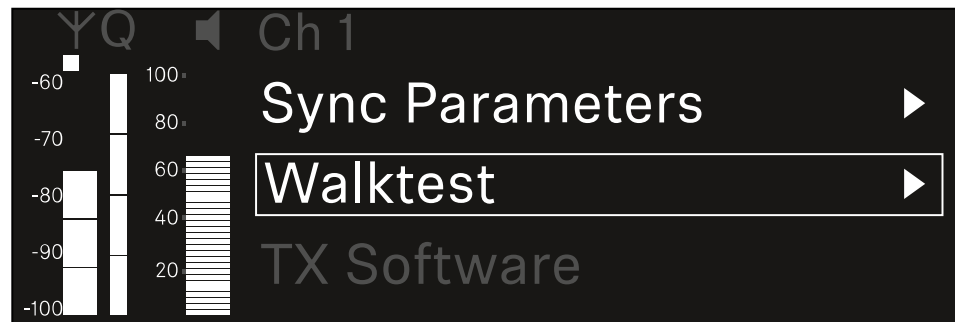

- ▷ Press the **jog dial** to open the menu.

➔ The following view is displayed:



To start the reception test:

- ▷ Press the **jog dial**.
- ▷ Walk the entire area on which you want to operate the system with the transmitter.
 - ➔ The following values are recorded on the display:
 - **RF**: Reception from antenna in dBm
 - **LQI**: Connection quality as a %, see [Meaning of the Link Quality Indicator](#)
 - **AF**: Transmitter audio frequency in dBFS



To end the reception test:

▷ Press the **Jog-Dial** to finish the walk test when you are ready.

ΥQ	Ch 1	Walktest		
		RF	LQI	AF
•				
•	Max	-92.4	0	-138.5
•	Min	-107.0	0	-138.5

Press SET to stop



Ch 1 / Ch 2 -> TX Software menu item

The **TX Software** menu item displays the software version of the received transmitter.

You cannot open this menu item to make settings.

- ▷ In the menu, navigate to the **TX Software** menu item for the desired channel.

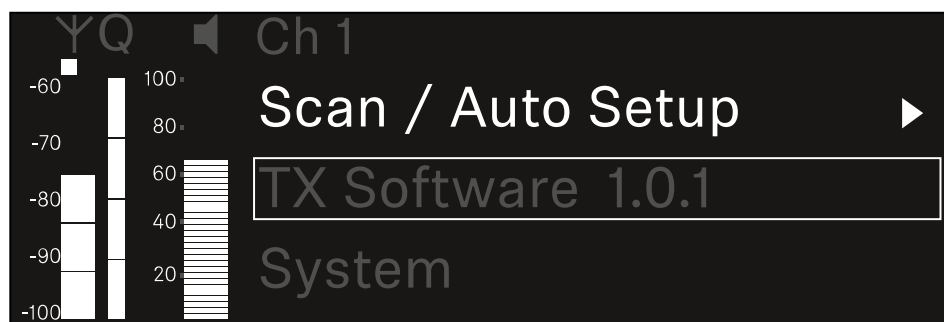

- ➔ The version number of the transmitter software is shown on the display. The transmitter must be switched on for this to be displayed.

i You can find information about updating the transmitter firmware in section [System -> TX Update menu item](#).



System menu item

In the System menu, you can make system-wide settings that will affect the entire device and not only the respective receiving channel.

The following menu items are available:

Encryption

- This menu item lets you secure the radio link with AES 256 encryption.
- [System -> Encryption menu item](#)

Link Density

- In this menu item, you can set the required transmission mode.
- [System -> Link Density menu item](#)

Network

- In this menu item, you can configure the settings for the network connection.
- [System -> Network menu item](#)

TX Update

- This menu item lets you perform a firmware update for the transmitters.
- [System -> TX Update menu item](#)

Auto Setup

- This menu item allows you to activate automatic frequency setup for the receiver.
- [System -> Auto Setup menu item](#)

This Device

- This menu item allows you to enter a device name and display information about the receiver's hardware and software.
- [System -> This Device menu item](#)



System -> Encryption menu item

You can secure the radio link between the transmitter and receiver using AES 256 encryption.

To open the **Encryption** menu item:

- ▷ In the System menu, navigate to the **Encryption** menu item.

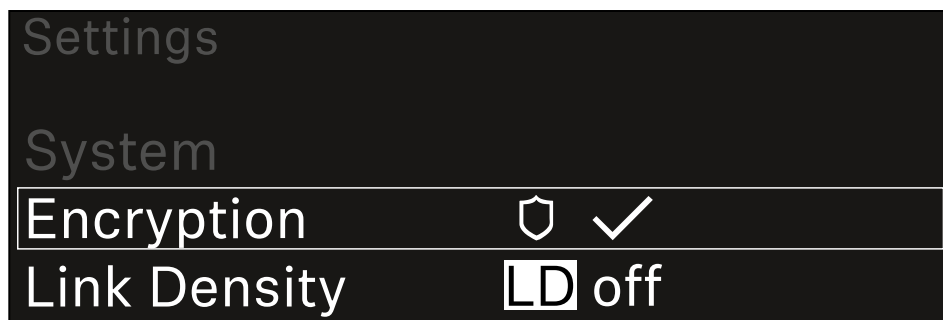

- ▷ Press the **jog dial** to open the menu.
 - ➔ The following view is displayed:

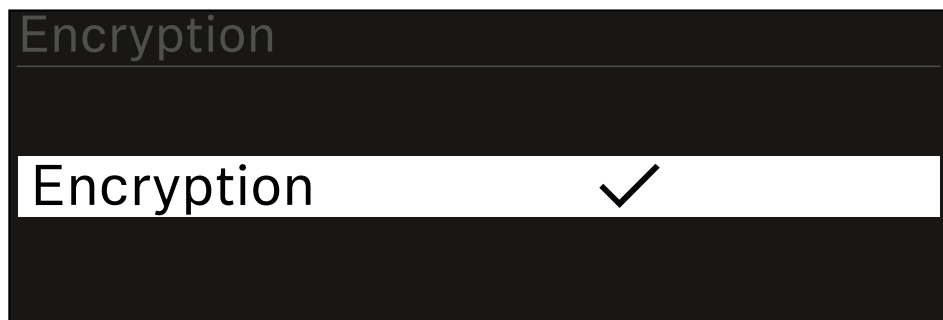

- ▷ Turn the **jog dial** to choose between the **On** and **Off** options.
- ▷ Press the **jog dial** to save your setting.

i After enabling AES 256 encryption, the connected transmitter must be resynchronized with the receiver to enable encryption on the transmitter as well.



System -> Link Density menu item

i Link Density mode (LD mode)

LD mode doubles the number of usable carrier frequencies in the available spectrum, as the minimum distance for the equidistant frequency grid is halved.

This is achieved by reducing the modulation bandwidth of the transmitter. This means that a much smaller frequency spacing between neighboring frequencies can be selected, and therefore more frequencies can be used in the same available spectrum without intermodulation.

LD mode is recommended if the following criteria are met:

- The required number of channels cannot be achieved using the normal mode, as there may be only a small spectrum available.
- The distance between the transmitters and the antennas is not too great.

To open the Link Density menu item:

- ▷ In the System menu, navigate to the **Link Density** menu item.



- ▷ Press the **jog dial** to open the menu.

➔ The following view is displayed:

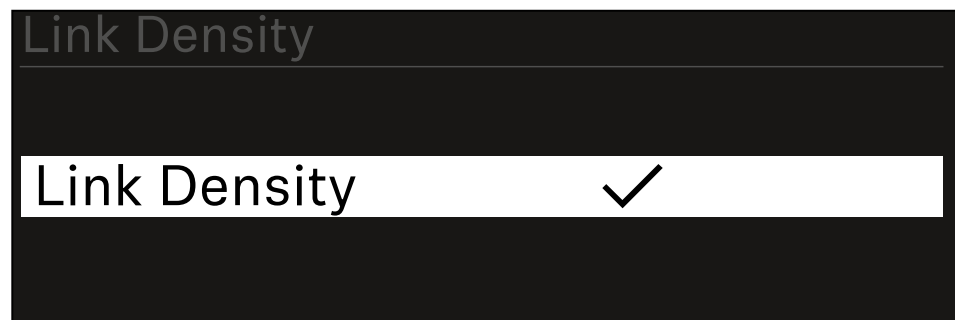

- ▷ Turn the **jog dial** to choose between the **On** and **Off** options.



- ▷ Press the **jog dial** to save your setting.
 - ➔ If you have enabled LD mode, the receiver must be restarted.

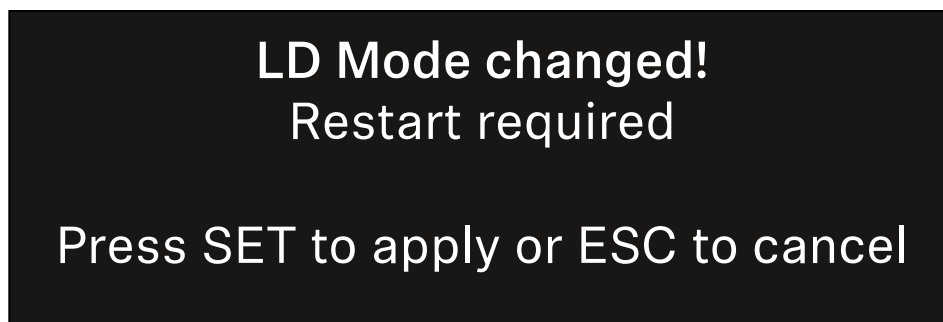

- ▷ Press the **jog dial** to restart the receiver.
 - Or
- ▷ Press the **ESC** button to cancel the mode change.

i After enabling LD mode and restarting the receiver, the connected transmitter must be resynchronized with the receiver to enable LD mode on the transmitter as well.



System -> Network menu item

In this menu item, you can configure the settings for the network connection.

To open the **Network** menu item:

- ▷ In the System menu, navigate to the **Network** menu item.

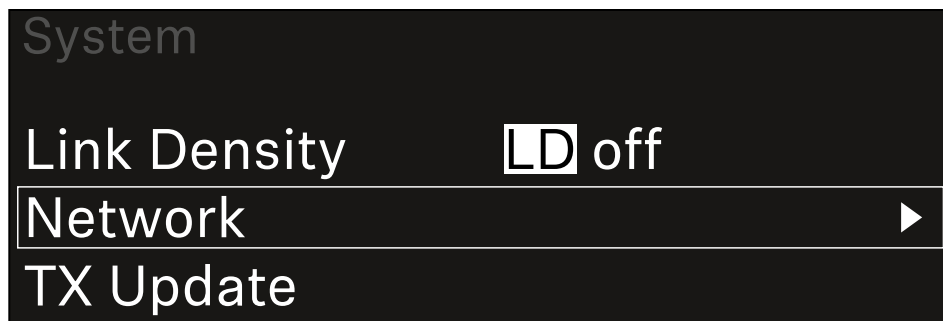

- ▷ Rotate the **jog dial** to navigate through the **Network** menu and select the desired menu item.

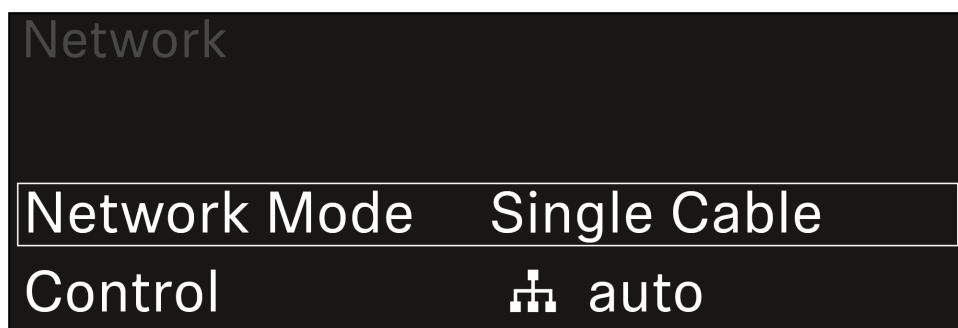



➔ You can make the following settings here:

Network Mode

- Single Cable
- Split 1
- Split 2
- Redundancy

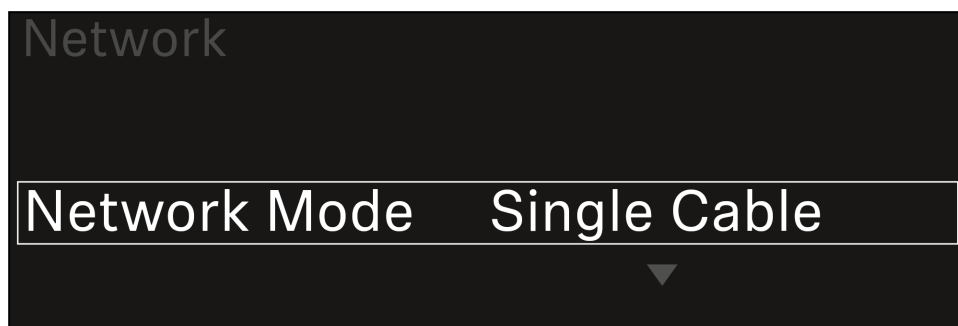

i See [Connecting receivers in a Dante® network.](#)

Control

- Mode
 - **Auto:** The network configuration is performed automatically.
 - **Manual:** The network configuration can be performed manually.
- mDNS
 - You can enable or disable this option if you want to use mDNS for automatic device detection in the network.
- IP
 - If the **Mode** option is set to **Auto**, the automatically assigned IP address is displayed here.
 - If the **Mode** option is set to **Manual**, you can set the IP address here.
- Netmask
 - If the **Mode** option is set to **Auto**, the automatically assigned netmask is displayed here.
 - If the **Mode** option is set to **Manual**, you can set the netmask here.
- Gateway
 - If the **Mode** option is set to **Auto**, the automatically assigned gateway is displayed here.
 - If the **Mode** option is set to **Manual**, you can set the gateway here.



Dante - Dante Primary and Dante Secondary

- Mode
 - **Auto:** The network configuration is performed automatically.
 - **Manual:** The network configuration can be performed manually.
- mDNS
 - You can enable or disable this option if you want to use mDNS for automatic device detection in the network.
- IP
 - If the **Mode** option is set to **Auto**, the automatically assigned IP address is displayed here.
 - If the **Mode** option is set to **Manual**, you can set the IP address here.
- Netmask
 - If the **Mode** option is set to **Auto**, the automatically assigned netmask is displayed here.
 - If the **Mode** option is set to **Manual**, you can set the netmask here.
- Gateway
 - If the **Mode** option is set to **Auto**, the automatically assigned gateway is displayed here.
 - If the **Mode** option is set to **Manual**, you can set the gateway here.

To save the settings you have made:

- ▷ Turn the **jog dial** until **Apply** appears in the selection frame.

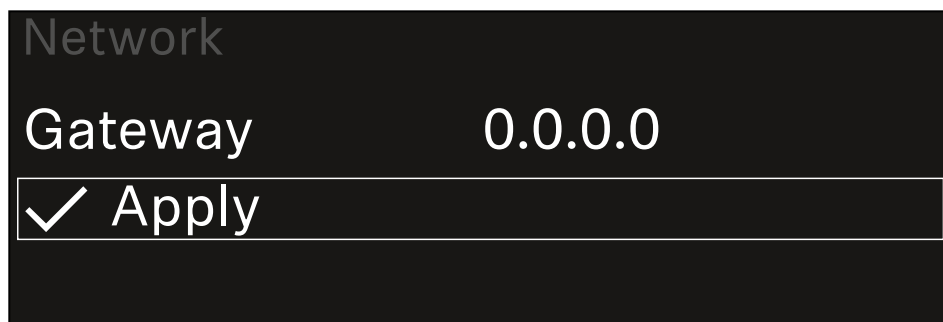

- ▷ Press the **jog dial** to save your settings.



System -> TX Update menu item

This menu item lets you perform a firmware update for the transmitters. This update is recommended after you perform a firmware update for the receiver (see [Updating the firmware of the receiver](#)).

- i** The firmware versions currently installed on the connected transmitter can be viewed under the TX Software menu item for the respective channel (see [Ch 1 / Ch 2 -> TX Software menu item](#)).

To open the TX Update menu item:

- ▷ In the System menu, navigate to the **TX Update** menu item.

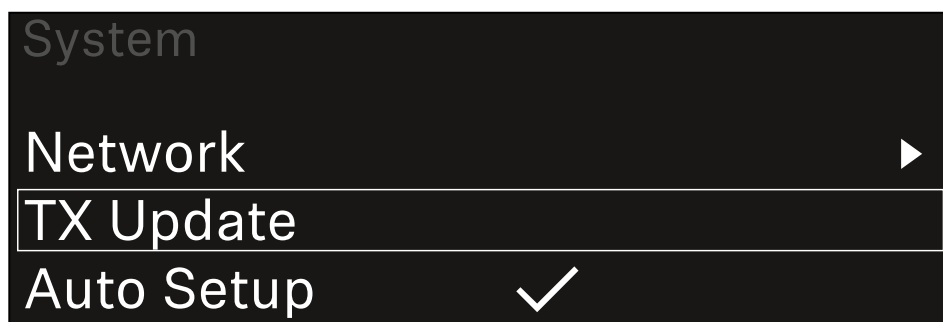

- ▷ Press the **jog dial** to open the menu.
 - ➔ The available sender firmware is displayed:

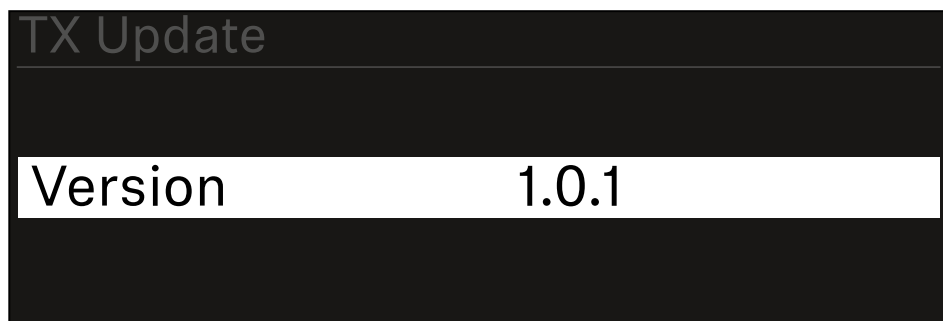



▷ Press the **jog dial** to start the firmware update.

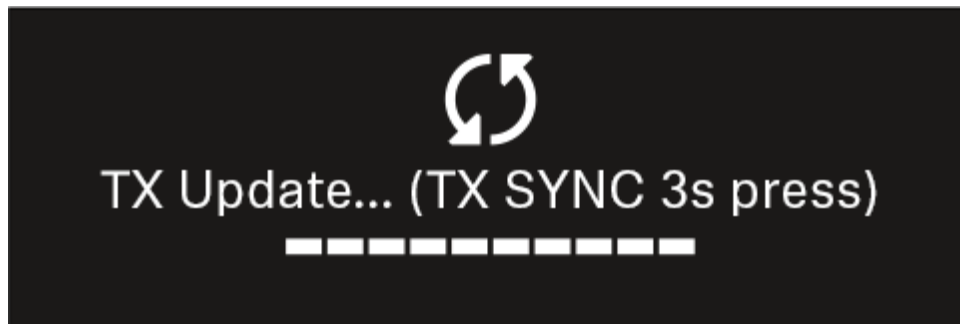

▷ Press the **SYNC** button on the connected transmitter for 3 seconds.

➔ You have about 20 seconds to do this. The progress bar shows the remaining time.

The system carries out the firmware update for the transmitter.

The progress of the update is shown on the receiver's display.

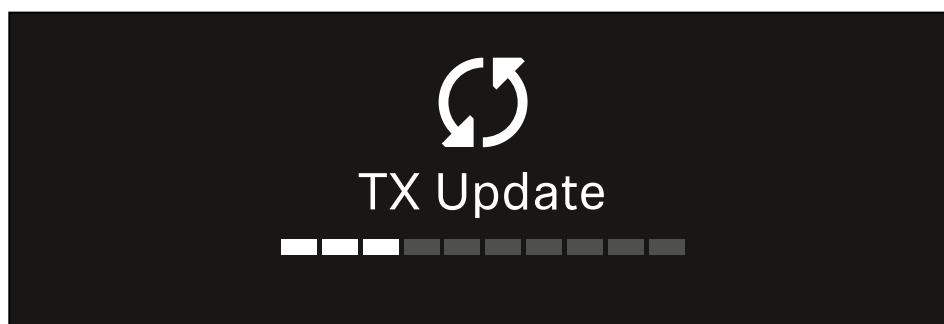

The transmitter's display shows that the firmware update is in progress.

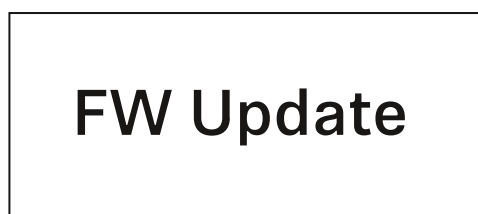



NOTICE



Canceling the update can impair the function of the transmitter

If the transmitter is turned off during the firmware update, the update may fail and the transmitter may cease to function correctly.

- ▷ Do not turn off the transmitter during the update.
- ▷ Do not remove the batteries or rechargeable battery pack during the update.
- ▷ Make sure that the transmitter's (rechargeable) batteries are sufficiently charged before updating.



System -> Auto Setup menu item

In this menu item, you can activate the **Auto Setup** function for the receiver.

If the function is activated here, you can perform an automatic frequency setup for both channels of this receiver via the **Scan / Auto Setup** menu item.

See [Ch 1 / Ch 2 -> Scan / Auto Setup menu item](#).

The receiver will also be enabled for automatic frequency setup in a network consisting of multiple receivers.

If the function is disabled here, you can only assign a frequency to the selected channel of the receiver via the **Scan / Auto Setup** menu item.

To open the Auto Setup menu item:

- ▷ In the System menu, navigate to the **Auto Setup** menu item.

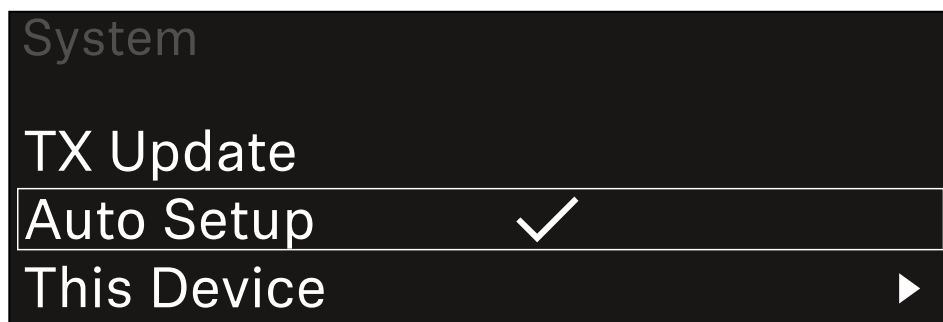

- ▷ Press the **jog dial** to open the menu.

➔ The following view is displayed:

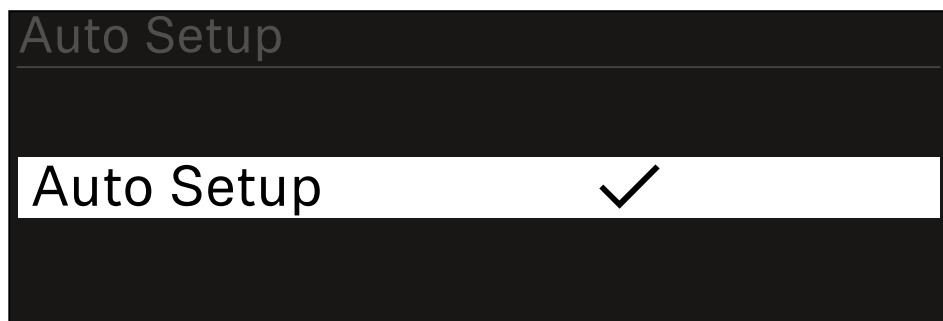

- ▷ Turn the **jog dial** to choose between the **On** and **Off** options.
- ▷ Press the **jog dial** to save your setting.



System -> This Device menu item

This menu item allows you to change the device name, view software and hardware information, or reset the device to factory settings.

To open the **This Device** menu item:

- ▷ In the System menu, navigate to the **This Device** menu item.

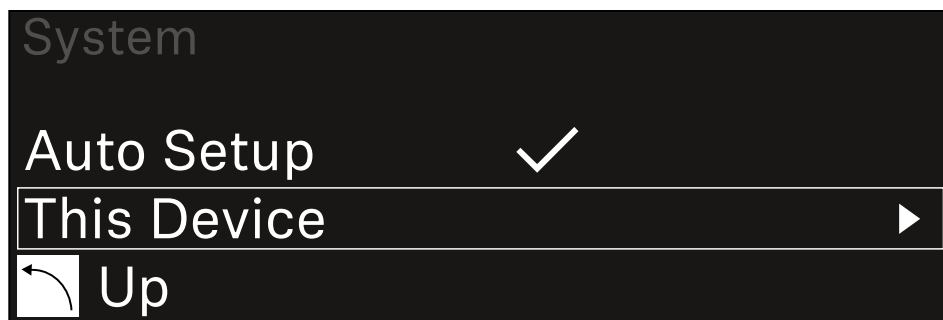

- ▷ Press the **jog dial** to open the menu.

➔ The following view is displayed:

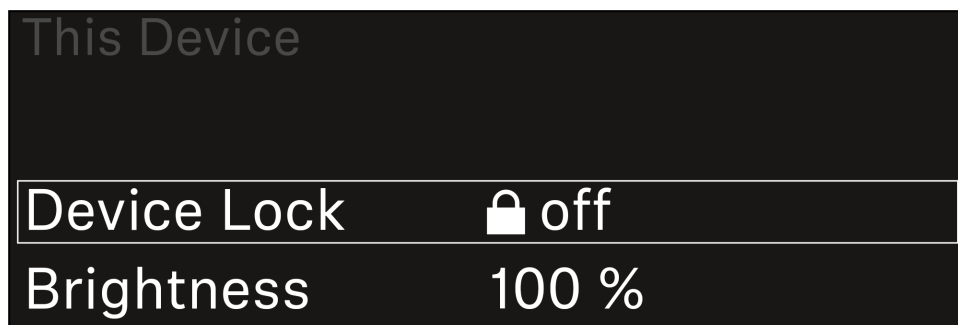

- ▷ Choose from the following:
 - **Device Lock:** Set the lock-off of the receiver.
 - **Brightness:** Set the brightness of the display.
 - **Device Name:** Open this menu item to change the device name. This receiver will be displayed in the network under this name.
 - **MAC:** Shows the MAC address of the receiver.
 - **Dante Name:** Shows the name of the device in the Dante network.
 - **Dante Pri MAC/Dante Sec MAC:** Shows the primary/secondary Dante MAC address of the receiver
 - **Software:** Shows the software version of the receiver.
 - **HW Main/HW Front/HW Tuner1/HW Tuner 2/HW Interface:** Displays the hardware versions of the boards installed in the receiver.
 - **Reset:** Resets the receiver to factory settings.



Updating the firmware of the receiver

You can update the receiver firmware using the **Sennheiser Control Cockpit** software, the **Wireless Systems Manager** software or the **Smart Assist** app.

Updating with the Sennheiser Control Cockpit or the Wireless Systems Manager:

- ▷ Connect the receiver to a network (see [Connecting receivers in a network](#)) and establish the connection with the software.

i For more information about controlling devices with the **Sennheiser Control Cockpit** or **Wireless Systems Manager** software, refer to the software help.

You can download the software here:

sennheiser.com/control-cockpit-software

sennheiser.com/wsm

i To update the transmitter's firmware, go to System -> TX Update in the menu on the receiver. See [System -> TX Update menu item](#)

Updating with the Smart Assist app:

- ▷ Connect the receiver to a network (see [Connecting receivers in a network](#)).
- ▷ Connect a wireless access point to the network.
- ▷ Connect your smartphone to this network.
- ▷ Start the update process in the **Smart Assist** app:
- ▷ Click on "Update" if the device is on the network.
- ▷ Follow the instructions.
- Or
- ▷ Search for devices that can be updated.
- ▷ Follow the instructions.



EW-DX EM 4 Dante rack receiver

- Product overview
- Connecting/disconnecting the receiver to/from the power supply system
- Connecting receivers in a network
- Connecting receivers in a Dante® network
- Connecting antennas
- Outputting audio signals
- Installing receivers in a rack
- Switching the receiver on and off
- Lock-off function
- Using the headphone output
- Meaning of the LEDs
- Displays on the receiver's display panel
- Home screens 2 and 3
- Channels 1 to 4
- Meaning of the Link Quality Indicator
- Buttons for navigating the menu
- Opening the menu and navigating the menu items
- Menu structure
- Setting options in the menu
- Ch 1 - Ch 4 -> Name menu item
- Ch 1 - Ch 4 -> Frequency menu item
- Ch 1 - Ch 4 -> Gain menu item
- Ch 1 - Ch 4 -> AF Out menu item
- Ch 1 - Ch 4 -> Trim menu item
- Ch 1 - Ch 4 -> Low Cut menu item
- Ch 1 - Ch 4 -> Cable Emul. menu item
- Ch 1 - Ch 4 -> Mute Mode menu item
- Ch 1 - Ch 4 -> Auto Lock menu item
- Ch 1 - Ch 4 -> LED menu item
- Ch 1 - Ch 4 -> Sync Parameters menu item
- Ch 1 - Ch 4 -> Scan/Auto Setup menu item
- Ch 1 - Ch 4 -> Walktest menu item
- Ch 1 - Ch 4 -> TX Software menu item
- System menu item
- System -> Encryption menu item
- System -> Link Density menu item
- System -> Network menu item
- System -> TX Update menu item
- System -> Auto Setup menu item
- System -> This Device menu item
- Updating the firmware of the receiver



Product overview

Front

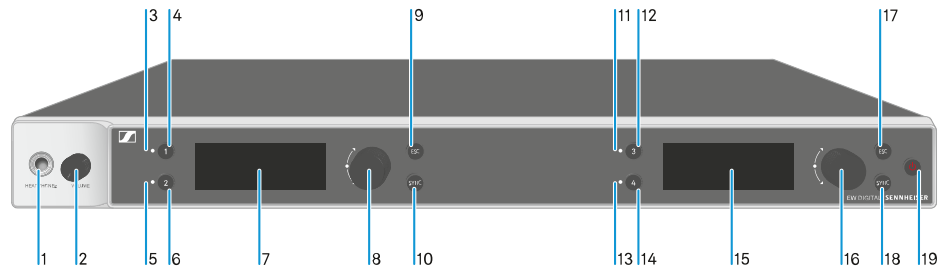

- 1 Headphone socket
 - See [Using the headphone output](#)
- 2 Volume control for the headphone socket
 - See [Using the headphone output](#)
- 3 **CH 1** LED to indicate the status of channel 1
 - See [Meaning of the LEDs](#)
- 4 **CH 1** button for selecting channel 1
 - See [Displays on the receiver's display panel](#)
 - See [Buttons for navigating the menu](#)
- 5 **CH 2** LED to indicate the status of channel 2
 - See [Meaning of the LEDs](#)
- 6 **CH 2** button for selecting channel 2
 - See [Displays on the receiver's display panel](#)
 - See [Buttons for navigating the menu](#)
- 7 Display for status information and operating menu
 - See [Displays on the receiver's display panel](#)



- 8 Jog dial (**UP/DOWN/SET**) for navigating the operating menu
 - See [Buttons for navigating the menu](#)

- 9 **ESC** button for canceling an action in the menu
 - See [Buttons for navigating the menu](#)

- 10 **SYNC** button for synchronizing the transmitter and receiver
 - See [Establishing a radio link | Synchronizing the receiver and transmitter](#)

- 11 **CH 3** LED to indicate the status of channel 3
 - See [Meaning of the LEDs](#)

- 12 **CH 3** button for selecting channel 3
 - See [Displays on the receiver's display panel](#)
 - See [Buttons for navigating the menu](#)

- 13 **CH 4** LED to indicate the status of channel 4
 - See [Meaning of the LEDs](#)

- 14 **CH 4** button for selecting channel 4
 - See [Displays on the receiver's display panel](#)
 - See [Buttons for navigating the menu](#)

- 15 Display for status information and operating menu
 - See [Displays on the receiver's display panel](#)

- 16 Jog dial (**UP/DOWN/SET**) for navigating the operating menu
 - See [Buttons for navigating the menu](#)

- 17 **ESC** button for canceling an action in the menu
 - See [Buttons for navigating the menu](#)



18 **SYNC** button for synchronizing the transmitter and receiver

- See [Establishing a radio link | Synchronizing the receiver and transmitter](#)

19 **ON/OFF** button for switching the device on and off

- See [Switching the receiver on and off](#)

Back

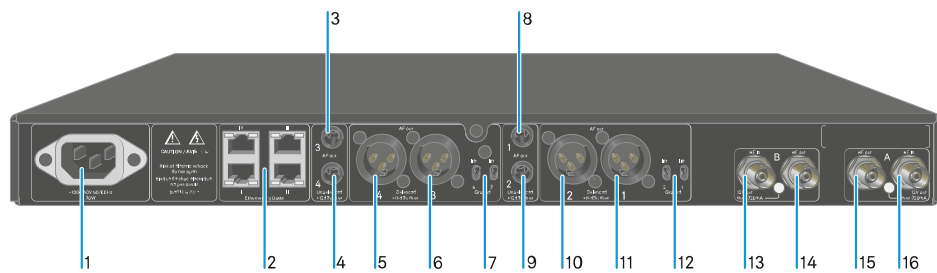

1 Power socket

- See [Connecting/disconnecting the receiver to/from the power supply system](#)

2 RJ-45 sockets: Control of the device via network using Wireless Systems Manager / Sennheiser Control Cockpit and Dante

- See [Connecting receivers in a network](#)
- See [Connecting/disconnecting the receiver to/from the power supply system](#)

3 6.3 mm jack socket for **AF out Unbalanced** audio output for channel 3

- See [Outputting audio signals](#)

4 6.3 mm jack socket for **AF out Unbalanced** audio output for channel 4

- See [Outputting audio signals](#)

5 XLR-3 socket for **AF out Balanced** audio output for channel 4

- See [Outputting audio signals](#)



- 6 XLR-3 socket for **AF out Balanced** audio output for channel 3
 - See [Outputting audio signals](#)
- 7 Groundlift for channel 4 and channel 3
 - See [Outputting audio signals](#)
- 8 6.3 mm jack socket for **AF out Unbalanced** audio output for channel 1
 - See [Outputting audio signals](#)
- 9 6.3 mm jack socket for **AF out Unbalanced** audio output for channel 2
 - See [Outputting audio signals](#)
- 10 XLR-3 socket for **AF out Balanced** audio output for channel 2
 - See [Outputting audio signals](#)
- 11 XLR-3 socket for **AF out Balanced** audio output for channel 1
 - See [Outputting audio signals](#)
- 12 Groundlift for channel 2 and channel 1
 - See [Outputting audio signals](#)
- 13 **ANT B in** BNC sockets, antenna inputs
 - See [Connecting antennas](#)
- 14 **ANT B out** BNC sockets, antenna outputs
 - See [Connecting antennas](#)
- 15 **ANT A out** BNC sockets, antenna inputs
 - See [Connecting antennas](#)
- 16 **ANT A in** BNC sockets, antenna outputs
 - See [Connecting antennas](#)



Connecting/disconnecting the receiver to/from the power supply system

To connect the receiver to the power supply system:

- ▷ Connect the mains cable IEC connector to the power socket on the rear side of the receiver.
- ▷ Connect the wall plug on the mains cable to a suitable wall outlet.

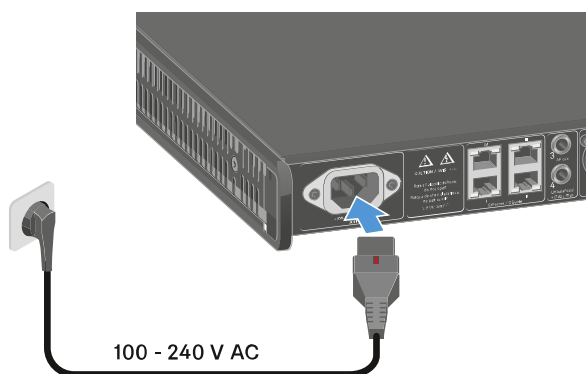

- i** If the booster voltage for antennas is activated in the menu (see [System -> This Device menu item](#)), it is active already before you switch on and after you switch off the receiver.

To completely disconnect the receiver from the power supply system:

- ▷ Unplug the mains cable plug from the wall socket.
- ▷ Slide the red switch back and simultaneously unplug the IEC connector of the mains cable from the power socket of the receiver.



Connecting receivers in a network

You can monitor and control one or more receivers via a network connection using the **Sennheiser Wireless Systems Manager (WSM)** or **Sennheiser Control Cockpit (SCC)** software.

- i** The network does not have to be a homogeneous network including only receivers. You can integrate the receiver into your existing network infrastructure with any other types of devices.

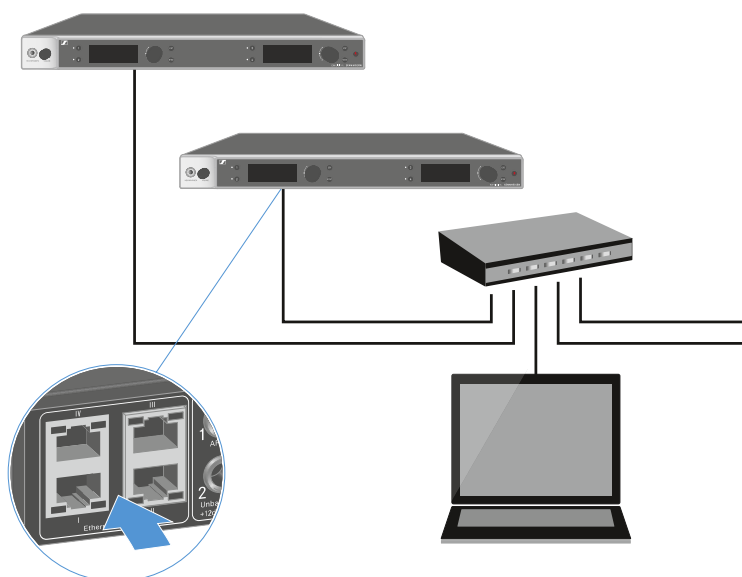

- i** For more information about controlling devices via the Sennheiser Wireless Systems Manager or Sennheiser Control Cockpit software, refer to the instruction manual for the software. You can download the software here:

sennheiser.com/wsm

sennheiser.com/control-cockpit-software



Connecting receivers in a Dante® network

Assignment of the network connections

The network connections have a different assignment depending on the network mode set.

The network mode can be changed in the **Network** menu, see [System -> Network menu item](#).

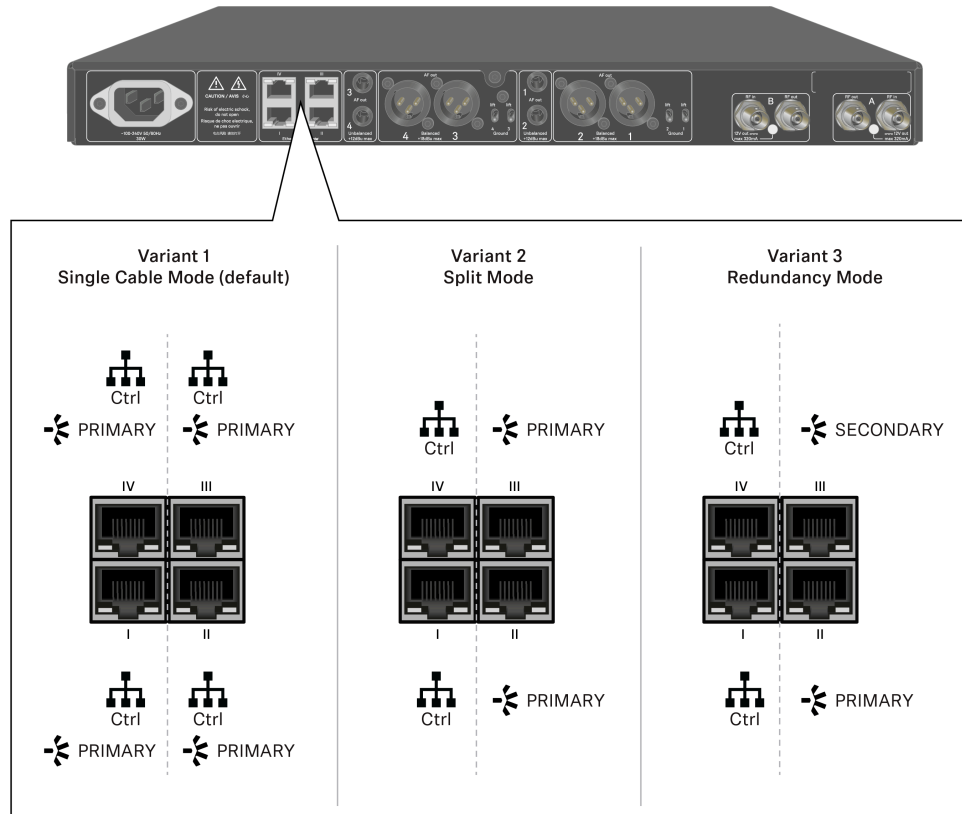

- i** Ctrl = network control via e.g. Wireless Systems Manager (WSM), Sennheiser Control Cockpit (SCC) or third-party media control
- PRIMARY = Dante® primary
- SECONDARY = Dante® secondary

Related information

[Information](#)

[Connections and network settings](#)



Information

The EW-DX EM 2 Dante and EW-DX EM 4 Dante receivers are equipped with a versatile network interface with selectable network modes for flexible signal transmission. Further information is available on the following pages.

In compact network systems that only have a limited number of receivers, the “Single Cable” mode is the best option. This straightforward setup simplifies the installation and reduces the cabling workload.

For larger, more extensive network configurations, the “Split or Redundancy Mode” is recommended. In these operating modes, the differing control data can be wired separately alongside the digital audio protocol data and also allow for redundant cabling.

When integrating several switches in a network, it is important to carefully consider the possible effects on the network performance. A selected operating mode can, if the cabling is faulty, restrict the network operation or lead to system failure. In this respect, it is also important to ensure that the network switches from the respective manufacturers that are used also support the data and audio protocols (e.g. Dante) and that they have been configured accordingly.

Detailed instructions can be obtained from the respective manufacturers of the individual software applications.

- ▷ First of all, set the network mode in the receiver, see EW-DX EM 2 Dante [System -> Network menu item](#) and EW-DX EM 4 Dante [System -> Network menu item](#).
- ▷ Note the assignment of the sockets and the wiring examples on the following pages.

i The following examples do not show all of the cabling options.

- ▷ Connect the cables.

i Information about the Dante Controller and the Dante network protocol settings is available on the Audinate website: audinate.com

i Information on the use of remote software is available in the download area of the Sennheiser website: sennheiser.com/download



Connections and network settings

Single cable mode

Factory setting

— Network control / Dante primary

— Dante primary

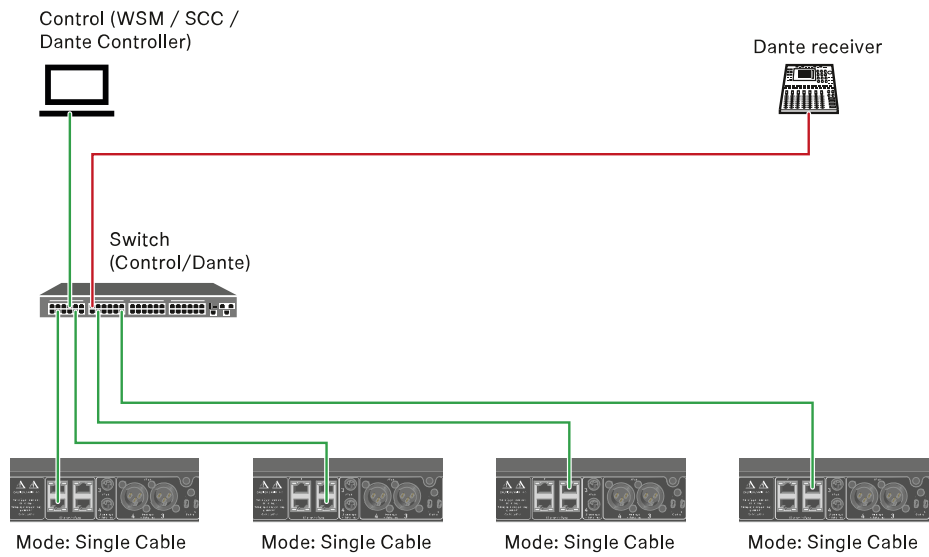

i The cable can be connected to network connections I, II or III.

Daisy-chain

— Network control / Dante

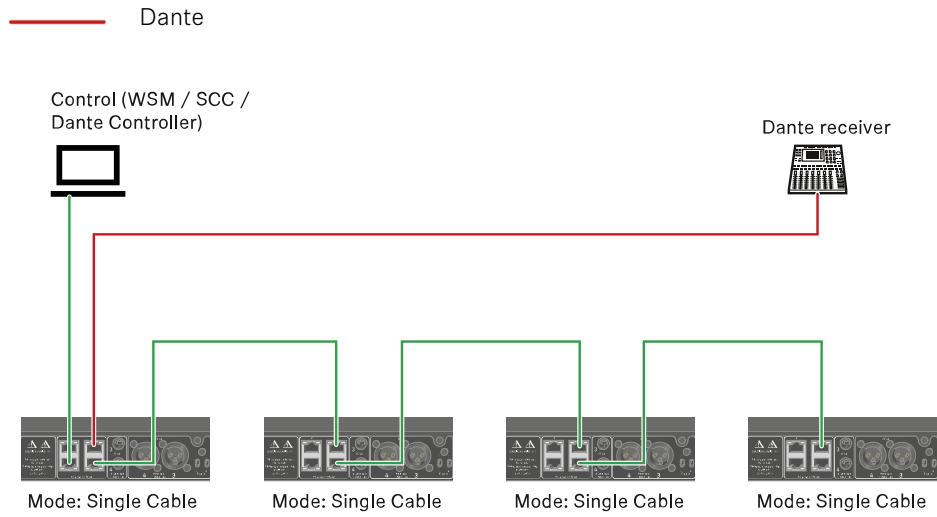

Split mode

Split 1 without daisy-chain

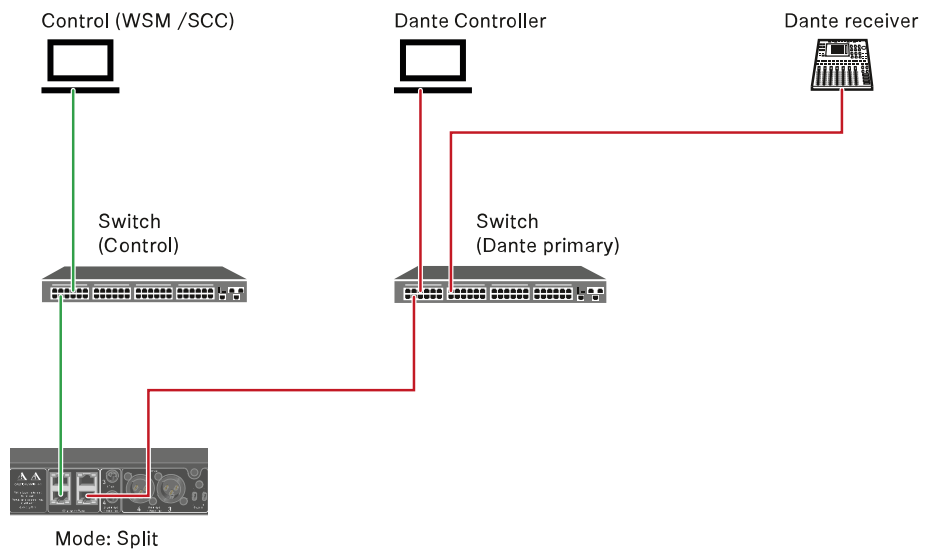
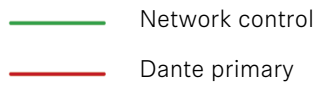

Split 1 with daisy-chain



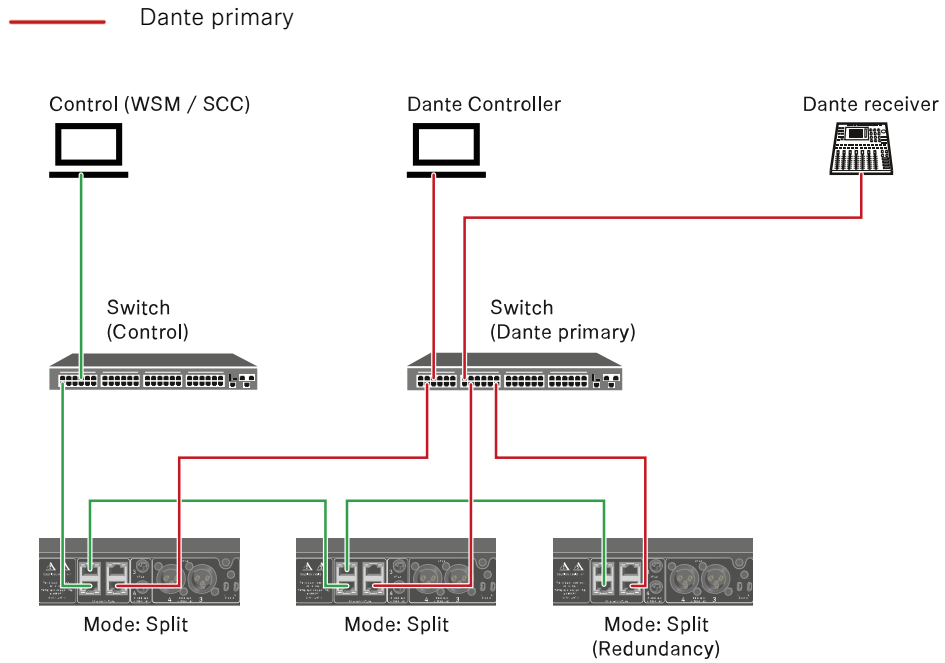

Redundancy mode

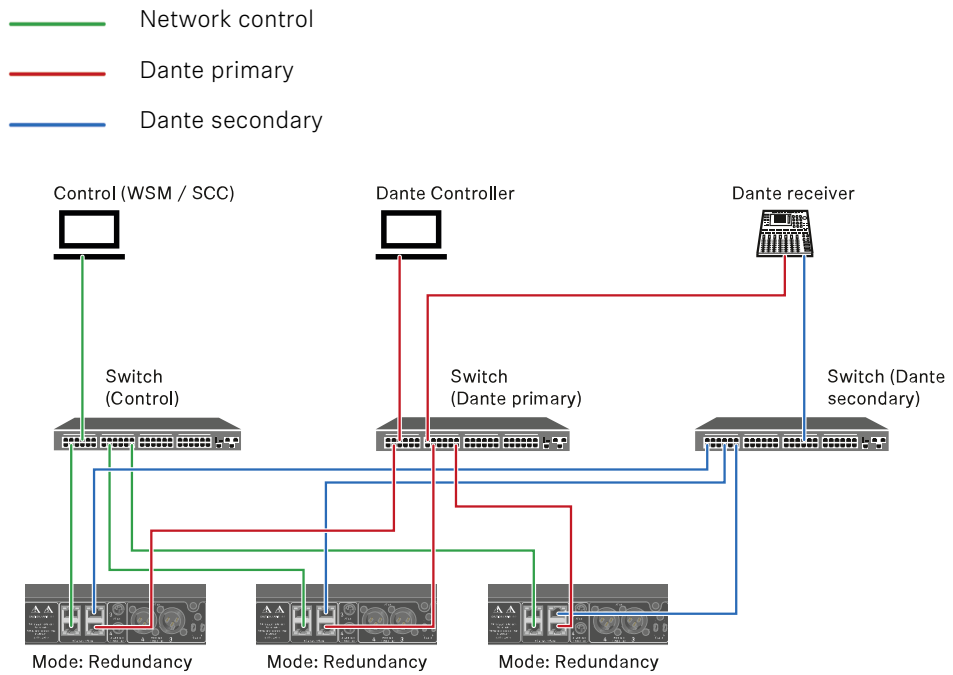



Connecting antennas

To connect the supplied rod antennas:

- ▷ Connect the antennas to the two antenna inputs on the receiver as shown in the figure.
- ▷ Slightly angle the antennas to the left and right as shown in the figure.



If you are using more than one receiver, we recommend using remote antennas and possibly the EW-D ASA antenna splitter ([EW-D ASA antenna splitter](#)).

To connect remote antennas:

- ▷ Connect the antennas to the two antenna inputs on the receiver as shown in the figure.

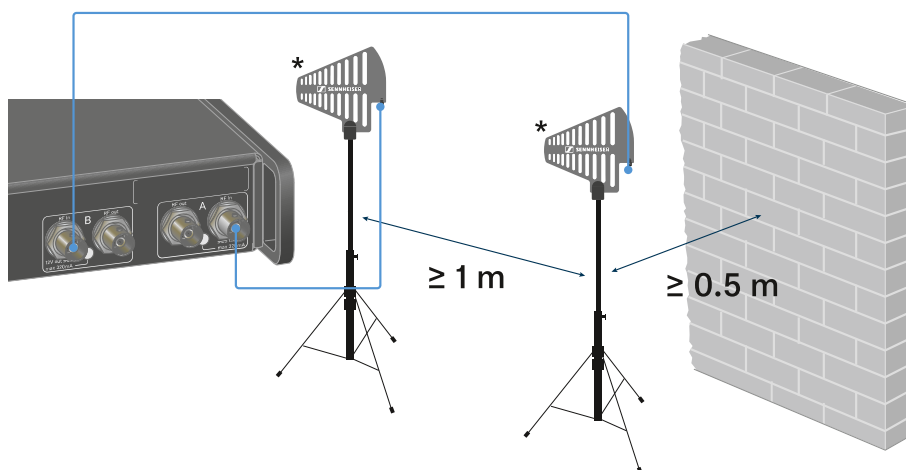

- ▷ Observe the specified minimum spacing.



▷ Observe the specified minimum spacing to the transmitters.

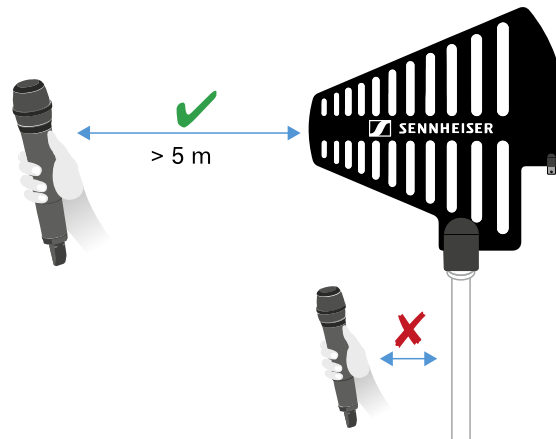

***Recommended antennas:**

- **ADP UHF** | 470 – 1075 MHz
- **AD 1800** | 1400 – 2400 MHz
- **AWM UHF I** | 470 – 694 MHz
- **AWM UHF II** | 823 – 1075 MHz
- **AWM 1G8** | 1785 – 1805 MHz

i If you are using more than one receiver, we recommend using remote antennas and possibly the [EW-D ASA antenna splitter](#) ([EW-D ASA antenna splitter](#)).



To cascade the receiver:

i The EW-DX EM 4 Dante receivers have a built-in antenna splitter. This enables you to cascade up to four receivers. This makes it possible to use 2 antennas/ antenna boosters for up to four receivers. All receivers use the same booster frequency range.

- ▷ Connect two antennas as described above.
- ▷ Connect the **RF out** socket of the first receiver to the corresponding **RF in** socket of another receiver using a short antenna cable.

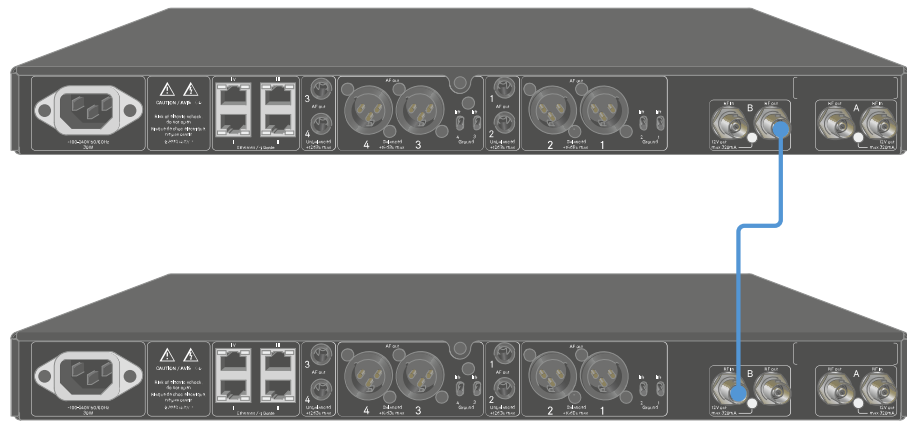

- ▷ Proceed as described in the previous step for a total of four receivers.



Outputting audio signals

Each of the four channels on the EW-DX EM 4 Dante has both a balanced XLR-3M output socket and an unbalanced 6.3 mm (1/4") jack output socket.

The balanced XLR -3M output has one Groundlift switch per channel, which interrupts the ground connection between pin 1 of the XLR connector.

- ▷ Always use only one of the two output sockets for each channel.

To connect an XLR cable:

- ▷ Plug the XLR cable into the **AF out Balanced** socket for the respective channel on the EW-DX EM 4 Dante.

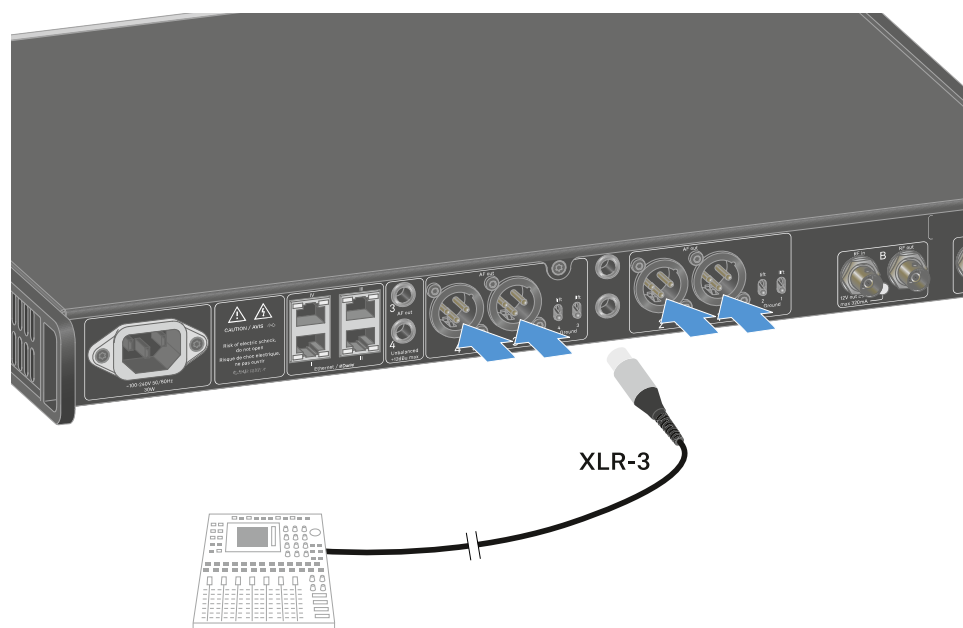



To connect a jack cable:

- ▷ Plug the jack cable into the **AF out Unbalanced** socket for the respective channel on the EW-DX EM 4 Dante.

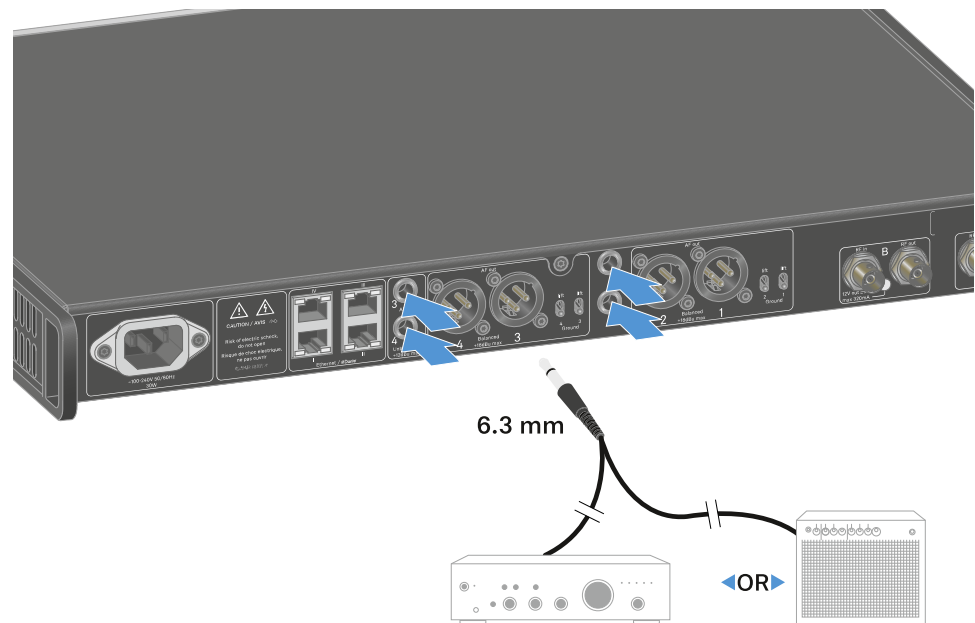

To output an audio signal via Dante:

- ▷ Connect the receiver as described under [Connecting receivers in a network](#).

To adjust the Groundlift:

- ▷ Slide the desired switch upwards.
 - ➔ Groundlift has been switched on for the corresponding **AF out Balanced** channel.

To switch Groundlift off:

- ▷ Slide the desired switch downwards.
 - ➔ Groundlift has been switched off for the corresponding **AF out Balanced** channel.



Installing receivers in a rack

You can install the receiver in any conventional 19" rack. The rack mounting angles are already attached to the device.

NOTICE



Rack mounting poses risks!

When installing the device in a closed 19" rack or multi-rack assembly, please consider that, during operation, the ambient temperature, the mechanical load and the electrical potentials will be different from those of devices which are not mounted into a rack.

- ▷ Make sure that the ambient temperature within the rack does not exceed the permissible temperature limit stated in the specifications. See [Specifications](#).
- ▷ Ensure sufficient ventilation; if necessary, provide additional ventilation.
- ▷ Make sure that the mechanical load of the rack is even.
- ▷ When connecting to the power supply system, observe the information indicated on the type plate. Avoid overloading the circuits. If necessary, provide overcurrent protection.
- ▷ When mounting in a rack, please note that intrinsically harmless leakage currents of the individual power supply units may accumulate, thereby exceeding the permissible limit value. As a remedy, ground the rack via an additional ground connection.

- ▷ Support the receiver after the installation in the rack.

i Due to the weight and depth of the device, there is a risk that it may break off in the rack and become damaged as a result.

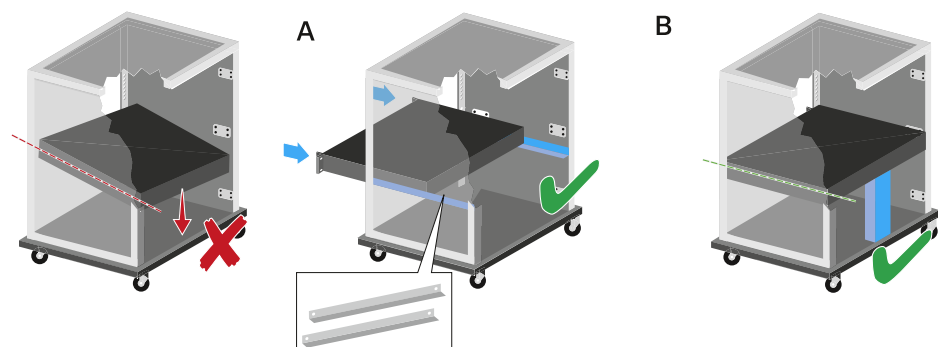



Version A

- ▷ Use special rack mounting rails.

i The design of the rack used must be suitable for the installation of these mounting rails.

Version B

- ▷ Use a suitable object to support the device on the rear side.
- ▷ Ensure that this object cannot become loose.



Switching the receiver on and off

To switch the receiver on:

- ▷ Short-press the **ON/OFF** button.
 - ➡ The receiver switches on.

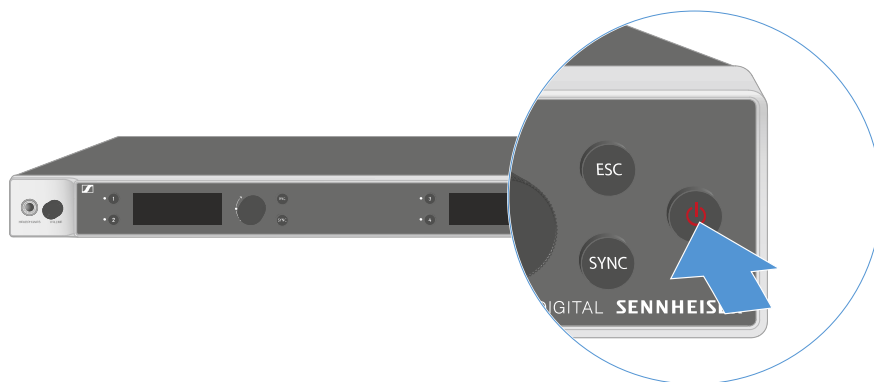

To switch the receiver to standby mode:

- ▷ If necessary, deactivate the lock-off function (see [Lock-off function](#)).
- ▷ Hold down the **ON/OFF** button until the display switches off.

To switch the receiver off completely:

- ▷ Disconnect the receiver from the power supply system by unplugging the power supply unit from the wall socket.



Lock-off function

You can enable or disable the automatic lock-off function in the **This Device** -> **Device Lock** menu item (see [System](#) -> [This Device menu item](#)).

To temporarily deactivate the lock-off function:

- ▷ Press the **jog dial**.
 - ➔ **Locked** appears in the display panel.
- ▷ Turn the **jog dial**.
 - ➔ **Unlock?** appears in the display panel.
- ▷ Press the **jog dial**.
 - ➔ Lock-off function is now temporarily deactivated.

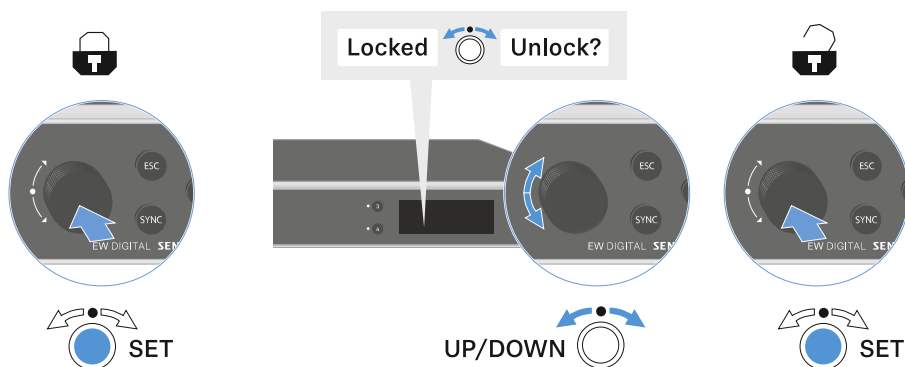

- ✓ The lock-off function remains deactivated while you are actively working in the operating menu.

i After 10 seconds of inactivity, it automatically activates again.



Using the headphone output

You can use the headphone output on the front of the receiver (6.3 mm jack) to listen to the audio signals of the four channels.

⚠ CAUTION



Danger due to high volume levels

Volume levels that are too high may damage your hearing.

- ▷ Turn down the volume of the headphone output before you put on the headphone.

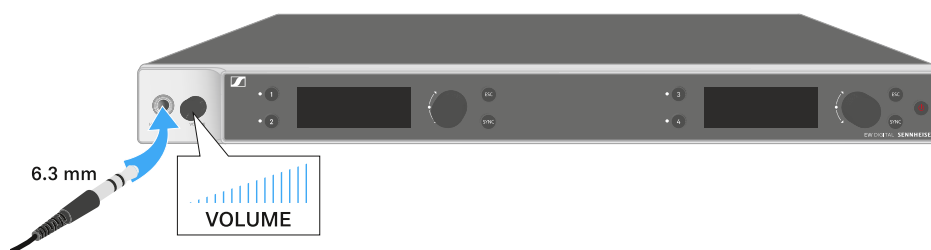

- ▷ Connect the headphone to the headphone output.
- ▷ Press the **Ch 1**, **Ch 2**, **Ch 3** or **Ch 4** button to listen to the audio signal from channel 1, channel 2, channel 3 or channel 4.
 - ➔ The headphone icon on the display indicates which channel is currently active on the headphone output. By default, the signal from channel 1 is active on the headphone output.
- ▷ You can control the volume by turning the volume knob next to the headphone output.



Meaning of the LEDs

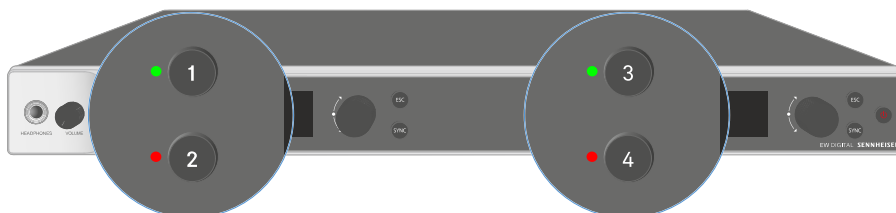

The four LEDs on the front of the receiver indicate the following information for channel 1, channel 2, channel 3 and channel 4.

The LED is green:



- The link between the transmitter and receiving channel is established.
- The audio signal is active.

The LED is yellow:



- The link between the transmitter and receiving channel is established.
- The audio signal is muted.



or

- No microphone module is mounted on the handheld transmitter.

The LED is flashing yellow:



- The link between the transmitter and receiving channel is established.
- The audio signal is overdriven (clipping).

The LED is continuously red:



- The link between the transmitter and receiving channel is established.
- The audio signal is overdriven (clipping).

The LED is flashing red:



- The link between the transmitter and receiving channel is established.
- The battery/rechargeable battery in the paired transmitter is low.

The LED is flashing blue:



- The **Bluetooth Low Energy** link is being established between the receiver and a smartphone or tablet with the **Smart Assist** app.

or

- The receiving channel is being synchronized with a transmitter.

The LED is blue:



- The firmware is being updated.
-



Displays on the receiver's display panel

Status information such as frequency, reception quality, battery status and audio level is shown on the display.

The display also shows the operating menu, which you can use to configure all of the settings (see [Buttons for navigating the menu](#)).

Home screen

The home screen is the default view on the display. The following information for receiving channel 1 and 2 or receiving channel 3 and 4 is displayed here.

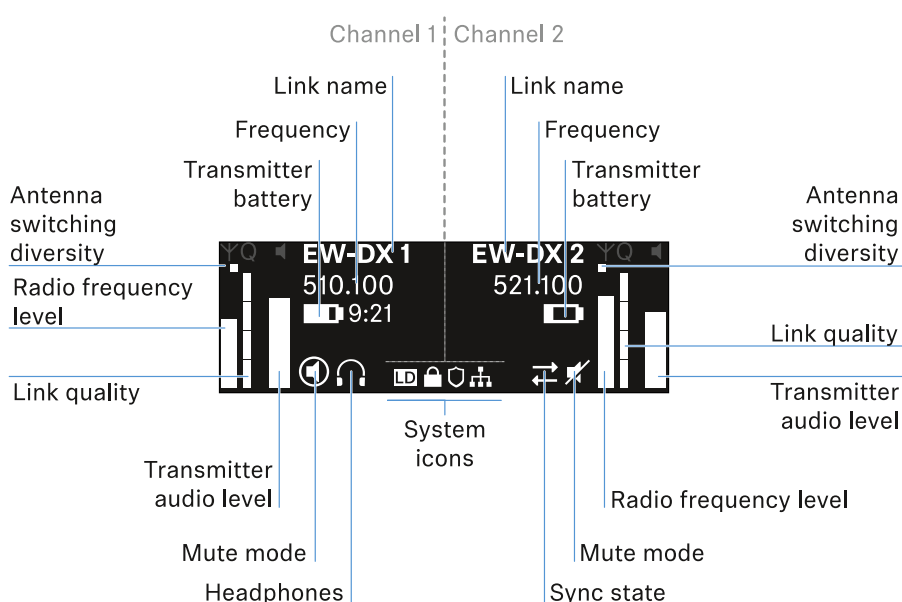

Antenna switching diversity:

Indicates which of the two antennas is currently active (left or right).

Signal level:

Displays the RF signal strength for the respective channel.

Link quality:

Displays the transmission quality for the respective channel.



i On the one hand, the transmission quality depends on the field strength (RF level indicator on the display). However, on the other hand, it also depends on external sources of interference that cannot be identified on the RF level indicator (for example, they may be on the same frequency or a very close neighboring frequency or may not affect the field strength).

As a basic principle, a value significantly higher than 50% should be achieved for a secure transmission.

Link name:

You can assign a name to the radio link in the receiver menu (see [Ch 1 - Ch 4 -> Name menu item](#)).

Frequency:

You can set the frequency of the radio link manually or using the Auto-Setup function.

- See [Ch 1 - Ch 4 -> Frequency menu item](#)
- See [Ch 1 - Ch 4 -> Scan/Auto Setup menu item](#)

Transmitter audio level:

Displays the audio input level for the respective channel (see [Ch 1 - Ch 4 -> Gain menu item](#)).

This level is separate from the audio level that is output from the receiver (see [Ch 1 - Ch 4 -> AF Out menu item](#)).

Transmitter battery:

Indicates the charging status of the transmitter's BA 70 rechargeable battery or batteries.

When using the BA 70 rechargeable battery, the remaining runtime is also displayed in hours and minutes.

Mute mode:



The mute switch is deactivated on the received transmitter.



The mute switch on the received transmitter is set to **AF Mute** and the audio signal is muted.

- [EW-DX SKM-S: Configuring mute mode and muting the handheld transmitter \(EW-DX SKM-S only\)](#)
- [EW-DX SK: Configuring mute mode and muting the bodypack transmitter](#)

Headphones:



The headphones icon indicates which channel is currently active on the headphone output (see [Using the headphone output](#)).

Sync state:



This icon indicates that different values are set for the receiving channel of the receiver and the transmitter. These values can be synchronized (see [Connecting to the EW-DX EM receivers / synchronizing the EW-DX EM](#)).

System icons:



The LD icon is displayed when Link Density mode is activated. See [System -> Link Density menu item](#).



The lock icon is displayed when the Auto Lock function is enabled. See [Lock-off function](#).



The network icon appears when a network connection is successfully established. See [Connecting receivers in a network](#).



The shield icon is displayed when AES 256 encryption is enabled. See [System -> Encryption menu item](#).

Related information

[Home screens 2 and 3](#)

[Channels 1 to 4](#)

[Meaning of the Link Quality Indicator](#)

Home screens 2 and 3

- ▷ Turn the **jog dial** on the home screen to the right.
 - ➔ The second home screen appears with network information for the device.
- ▷ Turn the **jog dial** to the right again.
 - ➔ The third home screen appears with information about the software and hardware.

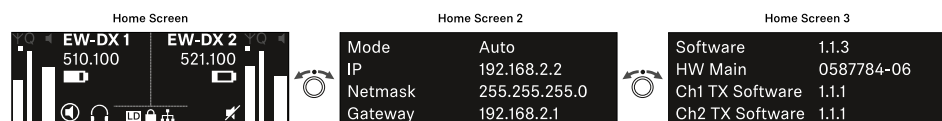



Channels 1 to 4

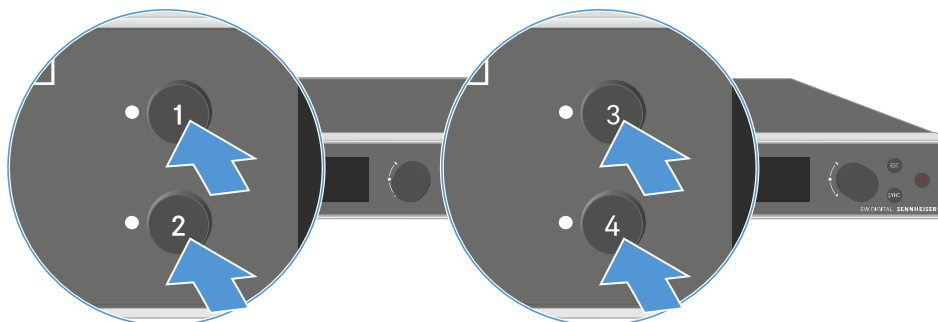

- ▷ On the receiver's home screen, press the **Ch 1**, **Ch 2**, **Ch 3** or **Ch 4** button.
- ➔ The home screen for channel 1, channel 2, channel 3 or channel 4 appears.

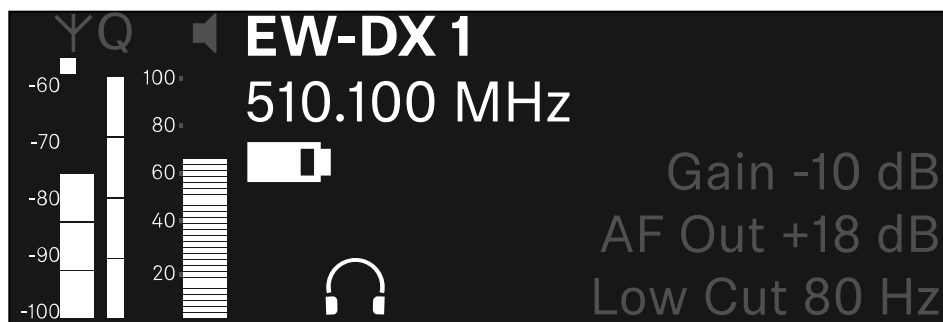

In addition to the status information displayed on the home screen, information about the channel's audio settings is also displayed.

- ▷ Turn the **jog dial** to the right to view more information about the received transmitter.

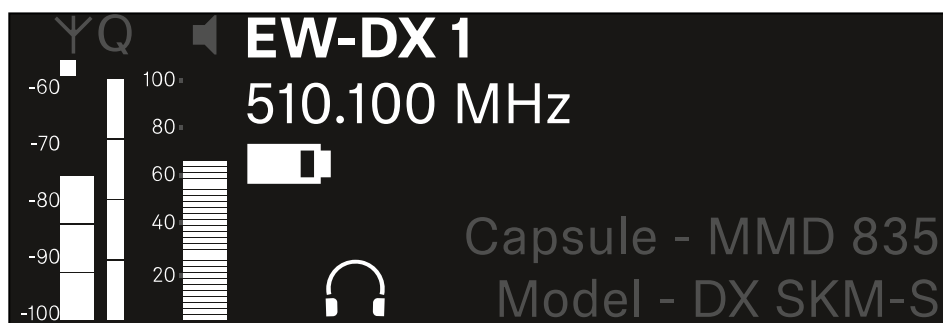



- ▷ Turn the **jog dial** further to the right to mute or unmute the channel's audio signal.

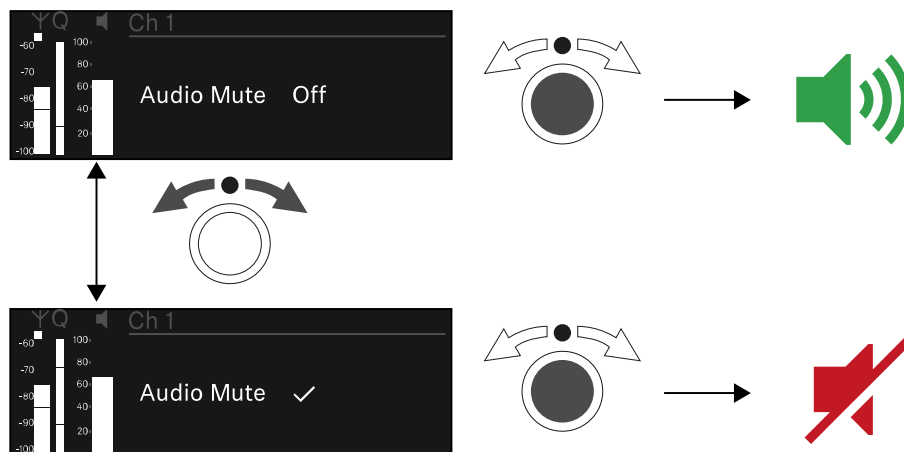

- ▷ Press the **jog dial** to confirm your selection.



Meaning of the Link Quality Indicator

The **LQI** (Link Quality Indicator) on the display of the receiver shows the transmission quality for the respective channel.

On the one hand, the transmission quality depends on the field strength (**RF** indicator on the receiving channel display). However, on the other hand, it also depends on external sources of interference that cannot be identified on the **RF** indicator (for example, they may be on the same frequency or a very close neighboring frequency or may not affect the RF strength).

As a basic principle, an LQI value significantly higher than 50% should be achieved for a secure transmission.

The LQI display shows the following information:

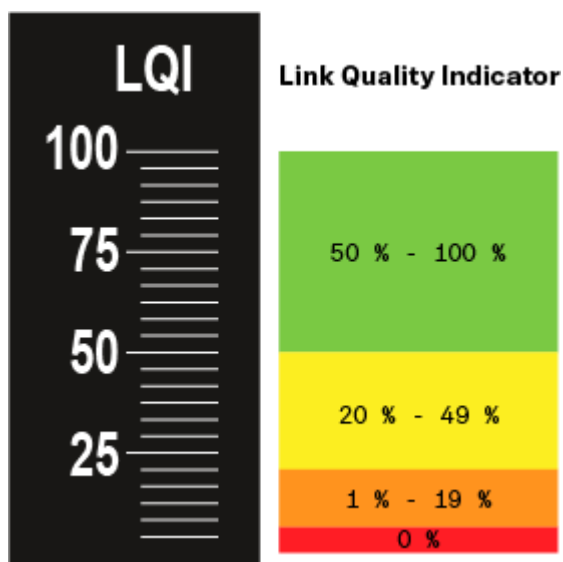

Green range from 50% to 100%:

- No transmission errors

The transmission quality is good enough to ensure an audio quality of 100%.

Yellow range from 20% to 49%:

- Individual transmission errors: short-term error correction active
- Individual audio artifacts may be audible

There are initial transmission errors. In rare cases, there are initial audible audio artifacts. Error correction may be active in this case.



Orange range from 1% to 19%:

- Frequent transmission errors: long-term error correction active
- Risk of audio drop-outs

The transmission errors increase, which means that the error correction duration also increases. There is a risk of audio drop-outs.

Red range 0%:

- No transmission

In this range, the transmission quality is so poor that audio drop-outs can no longer be avoided.



Buttons for navigating the menu

Use the following buttons to navigate through the receiver's operating menu.

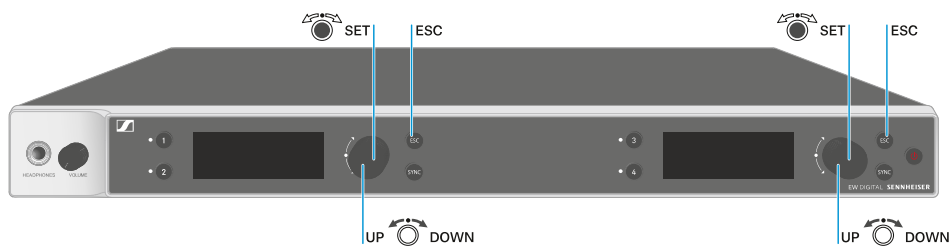

Press the **jog dial**

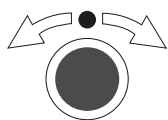

- Jumps from the home screen to the operating menu
- Calls up a menu item
- Changes to a submenu
- Saves settings

Turn the **jog dial**

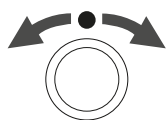

- Selects a standard display (see [Displays on the receiver's display panel](#))
- Changes to the previous or next menu item
- Changes the setting of a menu item

Press the **ESC** button



- Cancels the entry and returns to the previous display

i [Opening the menu and navigating the menu items](#)



Opening the menu and navigating the menu items

To open the menu:

- ▷ Press the **jog dial** when you are on the **home screen**.

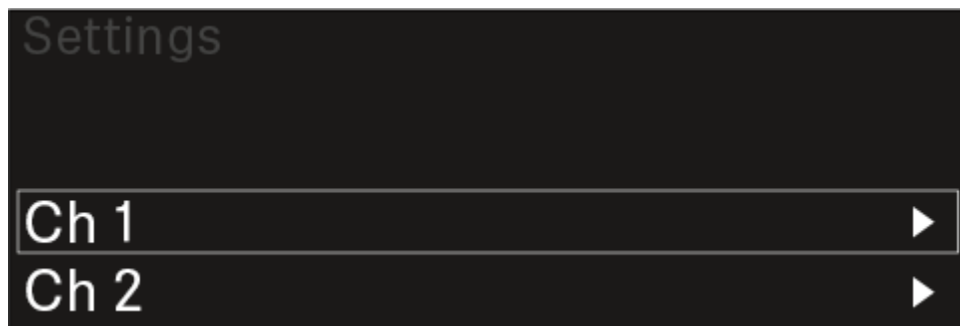

- ▷ Turn the **jog dial** to navigate to your desired menu item.
- ▷ Press the **jog dial** to open the selected menu item.

To exit the menu:

- ▷ Press the **ESC** button to exit the menu and return to the **home screen**.
 - ➡ Changes that were not previously saved by pressing the **jog dial** will be lost.

Related information

[Menu structure](#)

[Setting options in the menu](#)

[System menu item](#)



Menu structure

The figure shows the complete menu structure in an overview.

Version: firmware 3.0.0

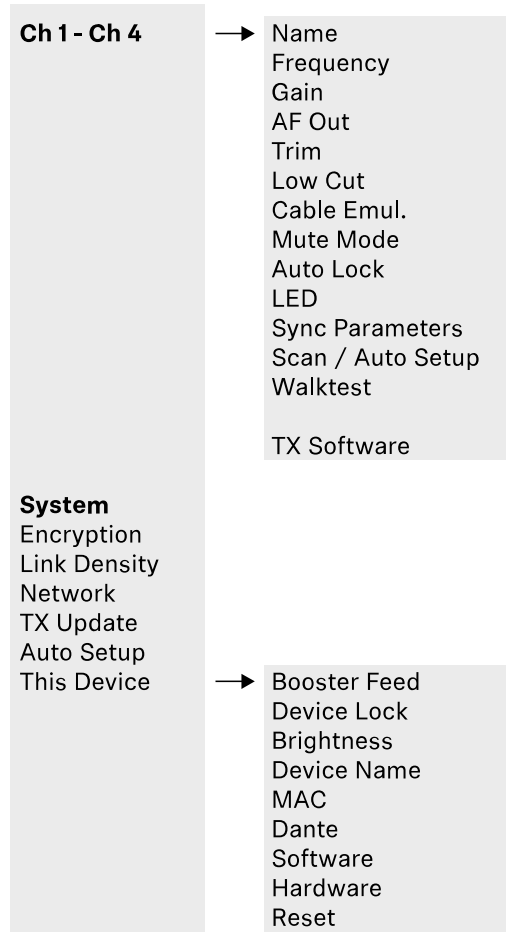



Setting options in the menu

In the receiver menu, you can configure the following settings.

Changing the name of the radio link

- [Ch 1 - Ch 4 -> Name menu item](#)

Adjusting frequencies

- [Ch 1 - Ch 4 -> Frequency menu item](#)

Adjusting the gain of the wireless link

- [Ch 1 - Ch 4 -> Gain menu item](#)

Setting the output level of the audio signal

- [Ch 1 - Ch 4 -> AF Out menu item](#)

Adjusting the trim of the connected transmitter

- [Ch 1 - Ch 4 -> Trim menu item](#)

Adjusting the low-cut filter

- [Ch 1 - Ch 4 -> Low Cut menu item](#)

Configuring cable emulation for the bodypack transmitter

- [Ch 1 - Ch 4 -> Cable Emul. menu item](#)

Setting the function of the transmitter's mute switch

- [Ch 1 - Ch 4 -> Mute Mode menu item](#)

Enabling the transmitter's automatic lock-off function

- [Ch 1 - Ch 4 -> Auto Lock menu item](#)

Configuring the behavior of the transmitter's LEDs

- [Ch 1 - Ch 4 -> LED menu item](#)

Activating/deactivating the parameters to be synchronized on the transmitters

- [Ch 1 - Ch 4 -> Sync Parameters menu item](#)



Performing a frequency scan and automatic frequency setup

- [Ch 1 - Ch 4 -> Scan/Auto Setup menu item](#)

Check the reception quality within the operating environment

- [Ch 1- Ch 4 -> Walktest menu item](#)

Viewing the software version of the connected transmitters

- [Ch 1 - Ch 4 -> TX Software menu item](#)

Configuring different system settings

- Enabling AES 256 encryption
- Setting transmission mode
- Configuring network settings
- Updating the firmware for the transmitters
- Activating the Auto Setup function
- Changing device names
- [System menu item](#)

i You can find an overview of the entire menu structure under [Menu structure](#).

Ch 1 - Ch 4 -> Name menu item

In the **Name** menu item, you can define the name of the link for the channel in question.

i This name is the name of the radio link between the transmitter and receiving channel. You can set the name of the receiver as it will appear in a network from the **This Device** menu in the system menu. See [System -> This Device menu item](#).



To open the Name menu item:

- ▷ In the menu, navigate to the **Name** menu item for the desired channel.

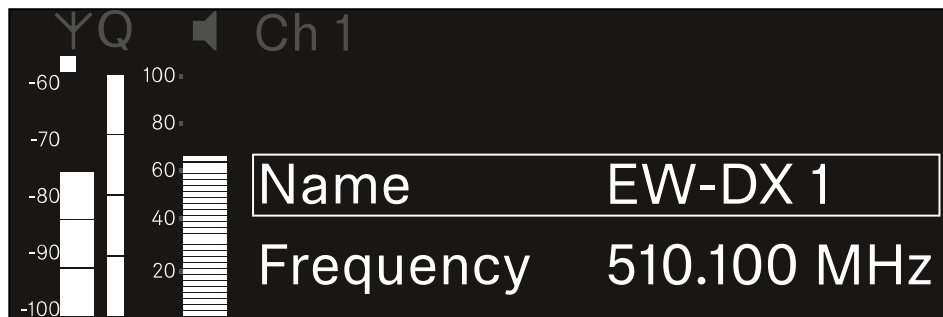

- ▷ Press the **jog dial** to open the menu.

➔ The following view is displayed:

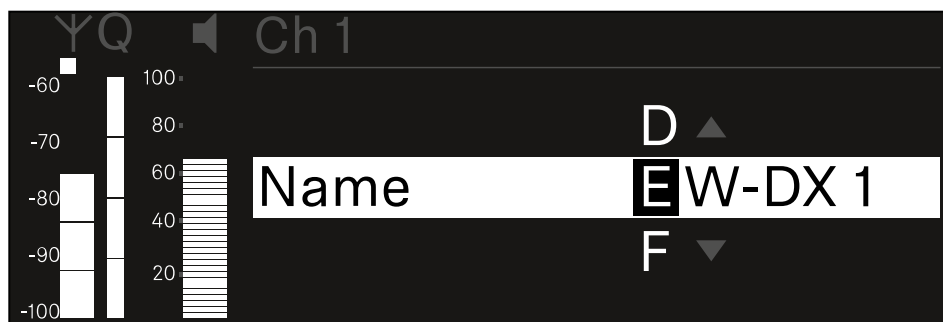

To enter the desired link name:

- ▷ Turn the **jog dial** to select the desired character.
 - ▷ Press the **jog dial** to go to the next position.
 - ▷ At the last position, press the **jog dial** to save the selected name.
- Or
- ▷ Press the **ESC** button to cancel the entry without saving the settings.

i For the chosen link name to appear on the display of the received transmitter, you must synchronize the channel ([Connecting to the EW-DX EM receivers / synchronizing the EW-DX EM](#)).



Ch 1 - Ch 4 -> Frequency menu item

In the **Frequency** menu item, you can adjust the frequency for the channel in question.

You can select a frequency from the predefined list or set the frequency manually.

To open the Frequency menu item:

- ▷ In the menu, navigate to the **Frequency** menu item for the desired channel.

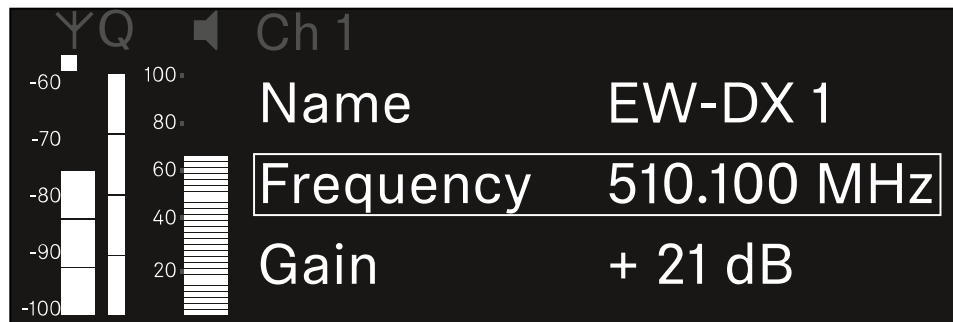

- ▷ Press the **jog dial** to open the menu.

➔ The following view is displayed:

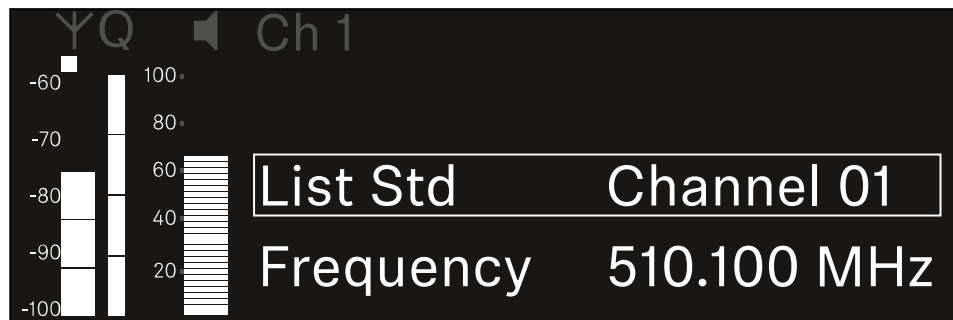

- ▷ Rotate the **jog dial** to select between the **List** and **Frequency** subitems.

➔ The **List** subitem allows you to select a frequency from the predefined list. The **Frequency** subitem lets you set the desired frequency manually.



To select a frequency from a predefined list:

- ▷ Open the **List** subitem.

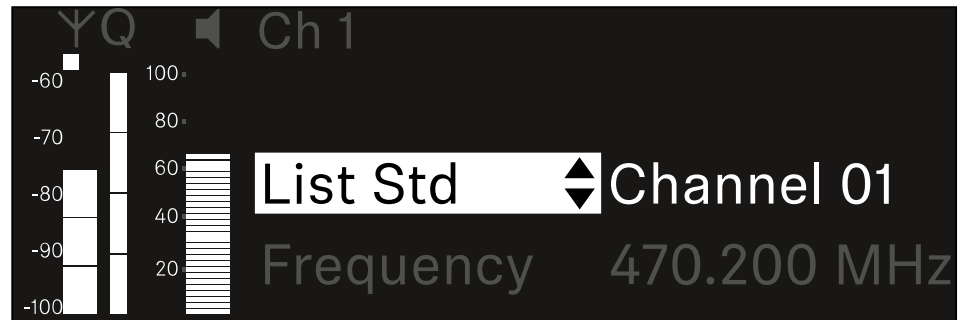

- ▷ Rotate the **jog dial** to choose between the predefined list (**List Std**) and the user-defined list (**List Usr**).

i You can create a custom list using the **Wireless Systems Manager** (WSM) software and upload it to the receiver. For more information on the **WSM** software, see:

sennheiser.com/wsm

- ▷ Press the **jog dial** to confirm your selection.

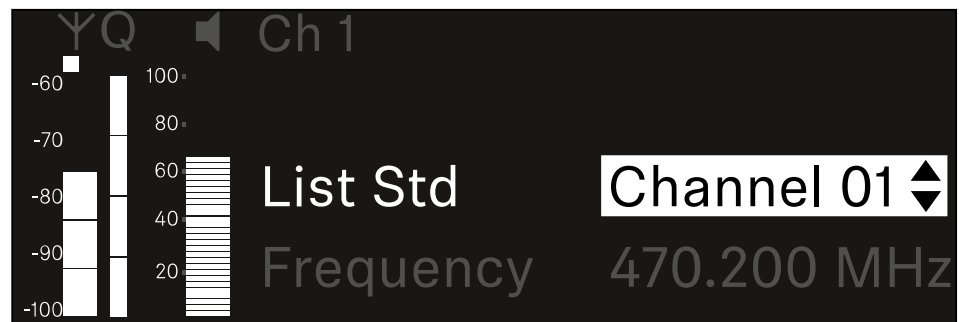

- ▷ Rotate the **jog dial** to select the desired channel from the list.
 - ➔ The frequency assigned to the channel is displayed.
- ▷ Press the **jog dial** to save the selected channel.
 - Or
- ▷ Press the **ESC** button to cancel the entry without saving the settings.



To set the frequency manually:

- ▷ Open the **Frequency** subitem.

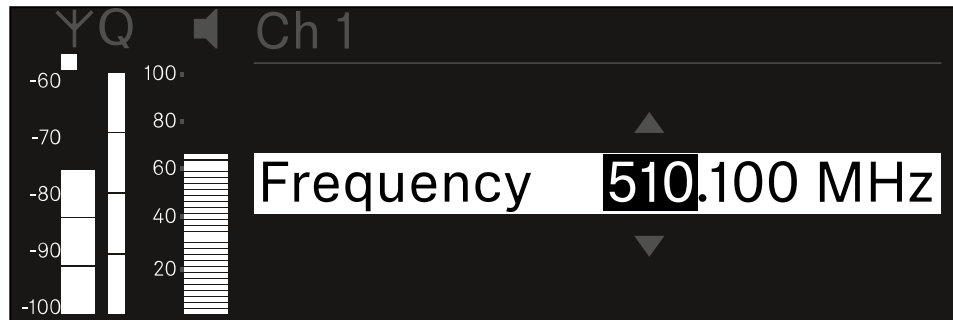

- ▷ Turn the **jog dial** to set the MHz range for the frequency.
- ▷ Press the **jog dial** to confirm your selection.

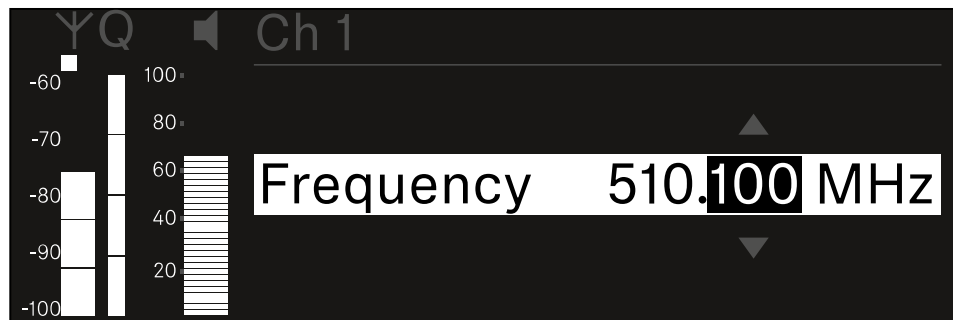

- ▷ Turn the **jog dial** to set the kHz range for the frequency.
- ▷ Press the **jog dial** to save your selected frequency.or
Or
- ▷ Press the **ESC** button to cancel the entry without saving the settings.



Ch 1 - Ch 4 -> Gain menu item

Under the **Gain** menu item, you can set the audio level of the audio signal coming from the received transmitter (e.g. vocals or speech via EW-DX SKM or guitar via EW-DX SK).

- Setting range: **-3 dB** to **+42 dB** in increments of 3 dB

To open the Gain menu item:

- ▷ In the menu, navigate to the **Gain** menu item for the desired channel.

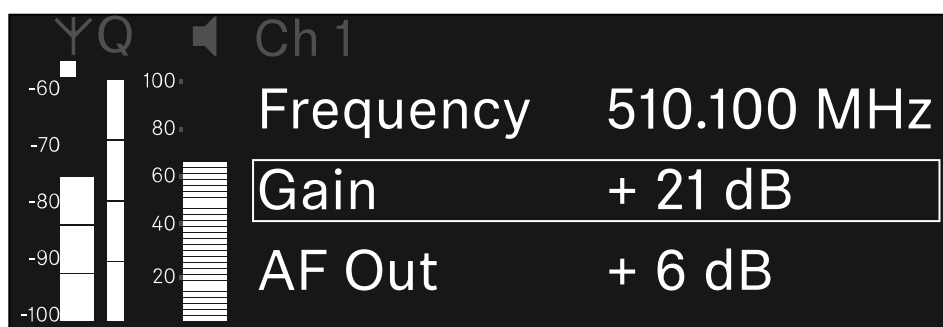

- ▷ Press the **jog dial** to open the menu.
➔ The following view is displayed:

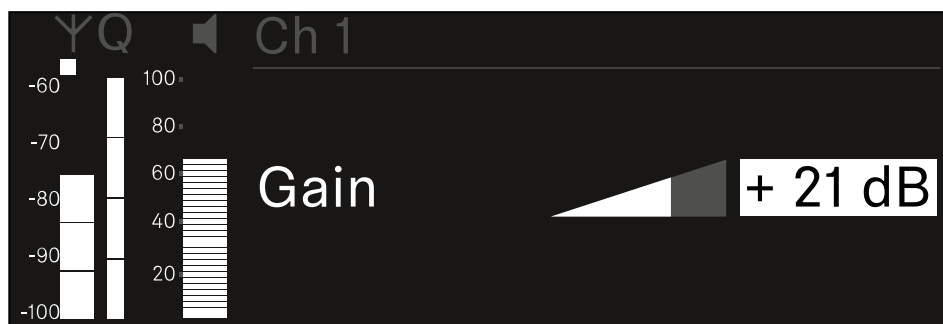

- ▷ Turn the **jog dial** to set the desired value.
- ▷ Press the **jog dial** to save your setting.
- Or
- ▷ Press the **ESC** button to cancel the entry without saving the settings.



Ch 1 - Ch 4 -> AF Out menu item

In the **AF Out** menu item, you can set the audio level that is output via the audio outputs of the particular receiving channel.

To open the **AF Out** menu item:

- ▷ In the menu, navigate to the **AF Out** menu item for the desired channel.



- ▷ Press the **jog dial** to open the menu.

➔ The following view is displayed:

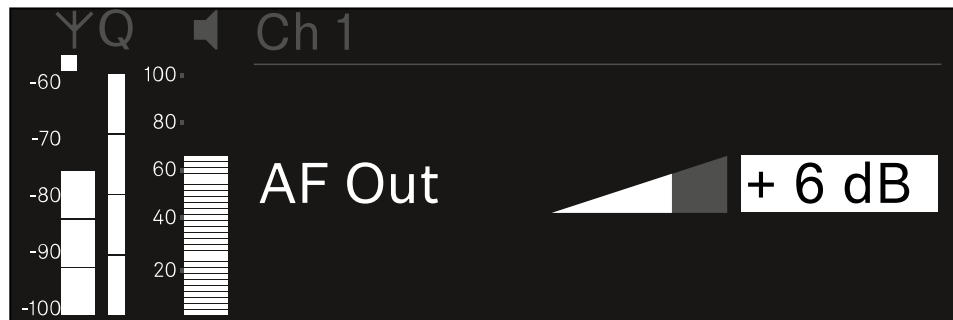

- ▷ Turn the **jog dial** to set the desired value.
- ▷ Press the **jog dial** to save your setting.
- Or
- ▷ Press the **ESC** button to cancel the entry without saving the settings.



Ch 1 - Ch 4 -> Trim menu item

In the **Trim** menu item, you can adjust the audio level of the received transmitter to input signals of different volumes.

i For example, if you are using multiple transmitters in alternation for a single receiving channel, you can adjust the transmitters to the different input signals using the trim setting. You do not need to change the channel's gain setting.

- Setting range: **-12 dB** to **+6 dB** in increments of 1 dB

To open the Trim menu item:

- ▷ In the menu, navigate to the **Trim** menu item for the desired channel.



- ▷ Press the **jog dial** to open the menu.

➔ The following view is displayed:

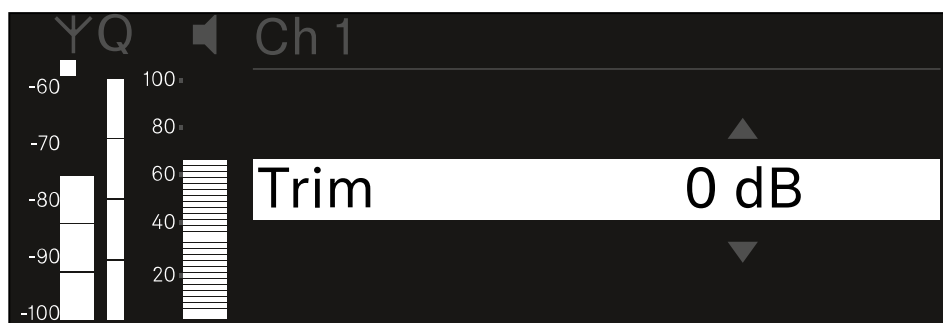

- ▷ Turn the **jog dial** to set the desired value.
- ▷ Press the **jog dial** to save your setting.
- Or
- ▷ Press the **ESC** button to cancel the entry without saving the settings.



- i** For the set value to be applied to the received transmitter, you must synchronize the channel ([Connecting to the EW-DX EM receivers / synchronizing the EW-DX EM](#)).



Ch 1 - Ch 4 -> Low Cut menu item

In the **Low Cut** menu item, you can set the value of the low cut filter for the respective channel.

Setting range:

- For **EW-DX SK | EW-DX SK 3-PIN**: Off, 30 Hz, 60 Hz, 80 Hz, 100 Hz, 120 Hz
- For **EW-DX SKM | EW-DX SKM-S**: 60 Hz, 80 Hz, 100 Hz, 120 Hz

To open the **Low Cut** menu item:

- ▷ In the menu, navigate to the **Low Cut** menu item for the desired channel.

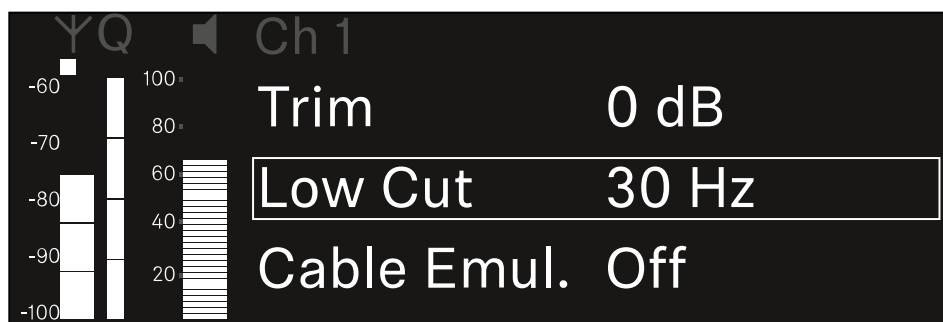

- ▷ Press the **jog dial** to open the menu.

➔ The following view is displayed:

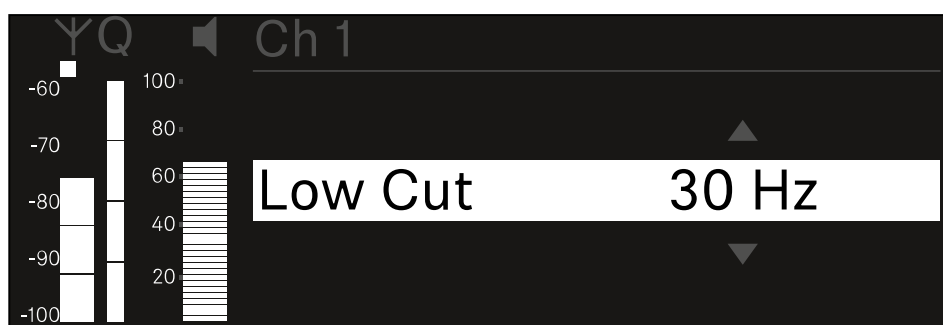

- ▷ Turn the **jog dial** to set the desired value.
- ▷ Press the **jog dial** to save your setting.
- Or
- ▷ Press the **ESC** button to cancel the entry without saving the settings.

i For the set value to be applied to the received transmitter, you must synchronize the channel ([Connecting to the EW-DX EM receivers / synchronizing the EW-DX EM](#)).



Ch 1 - Ch 4 -> Cable Emul. menu item

In the **Cable Emul.** menu item, you can emulate instrument cable lengths:

Setting range:

- Off, Type 1, Type 2, Type 3

To open the Cable Emul. menu item:

- ▷ In the menu, navigate to the **Cable Emul.** menu item for the desired channel.

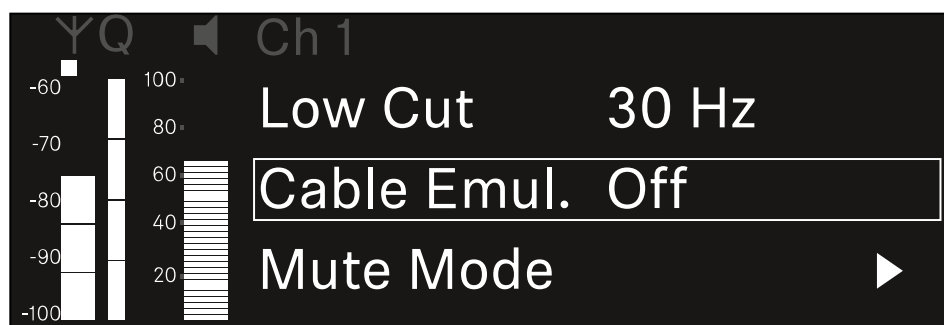

- ▷ Press the **jog dial** to open the menu.

➡ The following view is displayed:

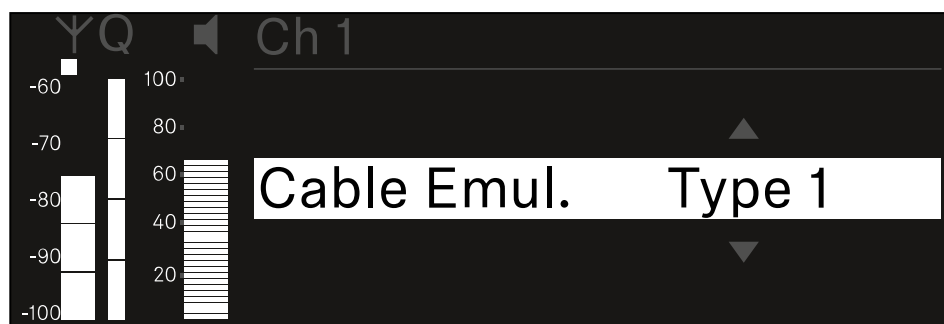

- ▷ Turn the **jog dial** to set the desired value.
- ▷ Press the **jog dial** to save your setting.
- Or
- ▷ Press the **ESC** button to cancel the entry without saving the settings.



Ch 1 - Ch 4 -> Mute Mode menu item

In the **Mute Mode** menu item, you can set the function of the mute switch on the connected transmitter (EW-DX SK, EW-DX SK 3-PIN, EW-DX SKM-S, EW-DX TS).

EW-DX SKM-S, EW-DX SK/EW-DX SK 3-PIN setting range:

- **Disabled:** The mute switch has no function.
- **RF Mute:** The RF signal is deactivated when the mute switch is on.
- **AF Mute:** The audio signal is muted when the mute switch is on.

EW-DX TS setting range:

- **Disabled:** The **MUTE** button has no function.
- **AF Mute:** The audio signal is muted when the **MUTE** button is pressed. Pressing the button again activates the audio signal.
- **PTT (Push to talk):** Press and hold the **MUTE** button to activate the audio signal.
- **PTM (Push to mute):** Press and hold the **MUTE** button to mute the audio signal.

To open the Mute Mode menu item:

- ▷ In the menu, navigate to the **Mute Mode** menu item for the desired channel.

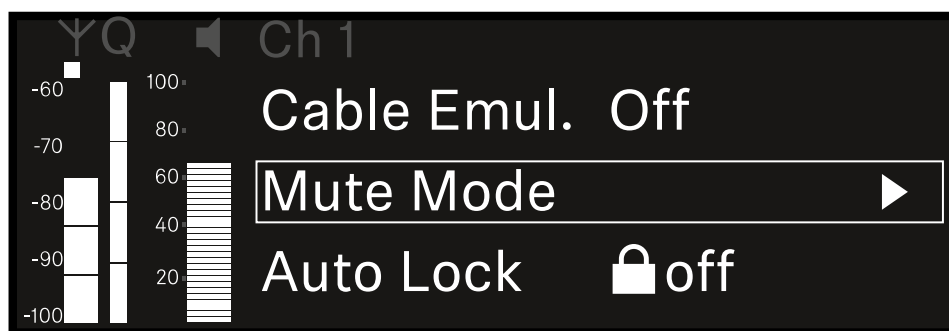

- ▷ Press the **jog dial** to open the menu.

➔ The following view is displayed:

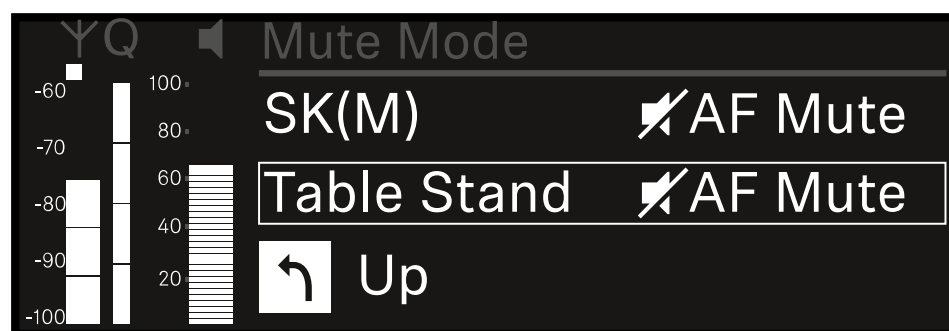



- ▷ Turn the **jog dial** to set the desired value.
- ▷ Press the **jog dial** to save your setting.
Or
- ▷ Press the **ESC** button to cancel the entry without saving the settings.

i For the set value to be applied to the received transmitter, you must synchronize the channel ([Connecting to the EW-DX EM receivers / synchronizing the EW-DX EM](#)).



Ch 1 - Ch 4 -> Auto Lock menu item

In the **Auto Lock** menu item, you can activate or deactivate the lock-off for the received transmitter.

The lock-off prevents the transmitter from being unintentionally switched off and also prevents any changes to the transmitter's menu.

i If you want to change settings in the transmitter's menu while the lock-off is active, you have to temporarily disable the lock-off:

- EW-DX SKM: [Lock-off function](#)
- EW-DX SK: [Lock-off function](#)

To open the **Auto Lock** menu item:

▷ In the menu, navigate to the **Auto Lock** menu item for the desired channel.

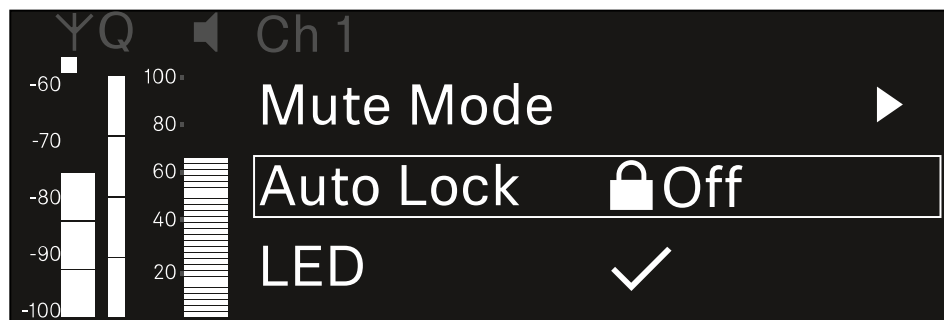

▷ Press the **jog dial** to open the menu.

➔ The following view is displayed:

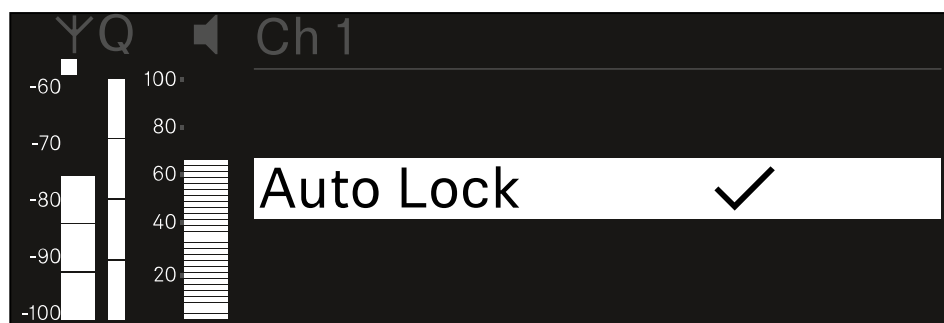

▷ Turn the **jog dial** to set the desired value.

▷ Press the **jog dial** to save your setting.

Or

▷ Press the **ESC** button to cancel the entry without saving the settings.



- i** For the set value to be applied to the received transmitter, you must synchronize the channel ([Connecting to the EW-DX EM receivers / synchronizing the EW-DX EM](#)).



Ch 1 - Ch 4 -> LED menu item

The **LED** menu item allows you to set the behavior of the LINK LED on the received transmitter.

Setting range:

- **ON:** The LINK LED remains continuously lit.
- **OFF:** The LINK LED switches off while the lock-off function is active.

i For this to occur, the automatic lock-off function must be enabled in the Auto Lock menu item (see [Ch 1 - Ch 4 -> Auto Lock menu item](#)).

To open the LED menu item:

- ▷ In the menu, navigate to the **LED** menu item for the desired channel.

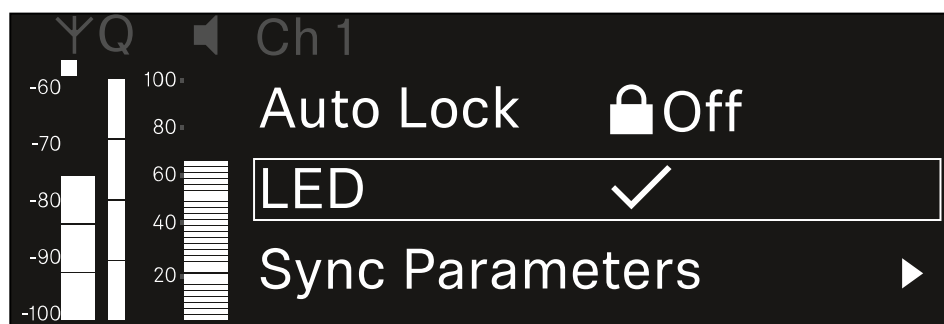

- ▷ Press the **jog dial** to open the menu.

➔ The following view is displayed:

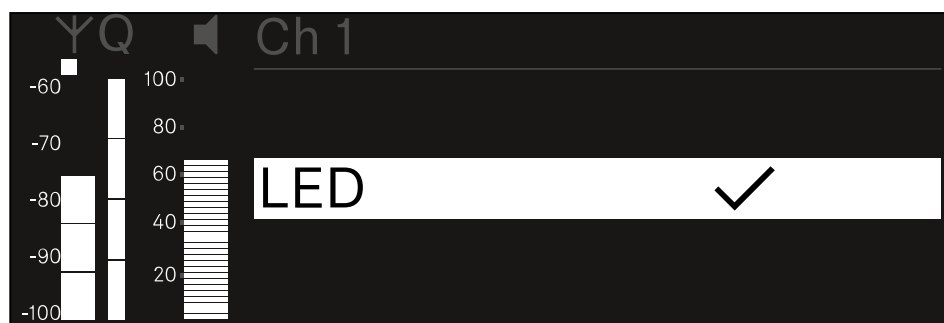

- ▷ Turn the **jog dial** to set the desired value.
- ▷ Press the **jog dial** to save your setting.
Or
- ▷ Press the **ESC** button to cancel the entry without saving the settings.



- i** For the set value to be applied to the received transmitter, you must synchronize the channel ([Connecting to the EW-DX EM receivers / synchronizing the EW-DX EM](#)).



Ch 1 - Ch 4 -> Sync Parameters menu item

In the **Sync Parameters** menu item, you can choose which settings for the transmitter you want to transfer from the receiver to the transmitter during the synchronization.

- i** All of the settings can also be set separately in the menu on the transmitter. During synchronization, the values set in the transmitter are overwritten with the values set in the receiver.

The following parameters can be enabled or disabled for transmission.

- Name
- Frequency
- Trim
- Low Cut
- Cable Emul.
- Mute Mode
- Auto Lock
- LED

To open the Sync Settings menu item:

- ▷ In the menu, navigate to the **Sync Settings** menu item for the desired channel.

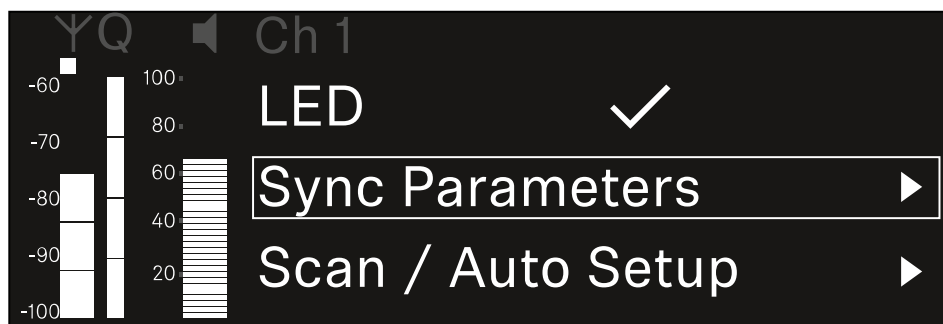

- ▷ Press the **jog dial** to open the menu.



➔ The following view is displayed:

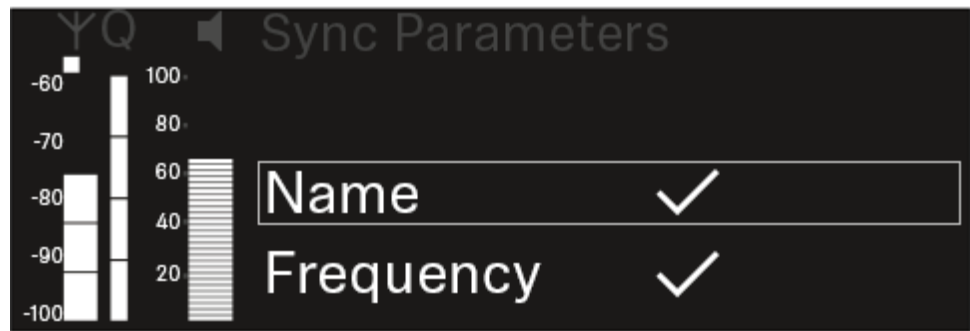

- ▷ Turn the **jog dial** to choose between the options.
- ▷ Press the **jog dial** to open your selected option.

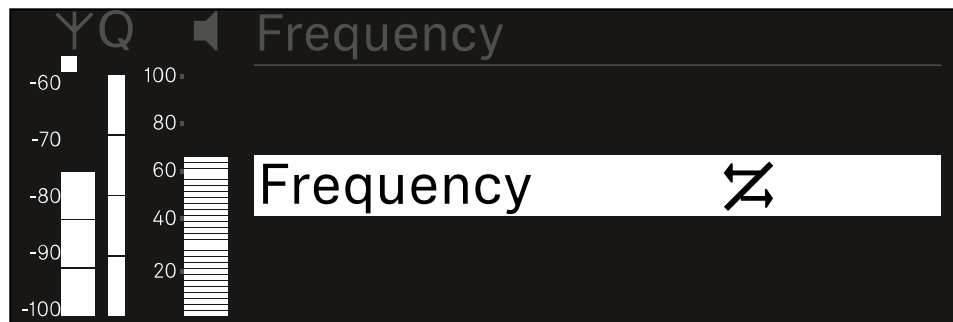
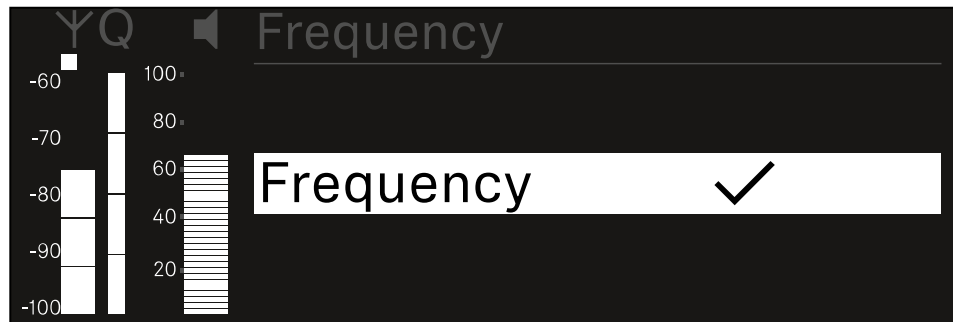

- ▷ For each option, select whether it will be synchronized or not.
 - ✓ The value set for this function will be transferred during synchronization.
 - ✗ The value set for this function will not be transferred during synchronization.

▷ Press the **jog dial** to save your setting.



Ch 1 - Ch 4 -> Scan/Auto Setup menu item

The receiver lets you scan the frequency spectrum and display all of the free frequencies in the selected frequency range. The automatic frequency setup can be used to distribute the free frequencies to all of the EW-DX EM 4 devices available in the network automatically.

▷ Switch off all transmitters before you perform the scan.

➔ If transmitters are still switched on, they are detected as unavailable frequencies and the frequencies that are actually available cannot then be used.

i To perform the automatic frequency setup for all devices in the network, the Auto Setup function must be enabled in the receiver's system menu: [System -> Auto Setup menu item](#)

i An EM that is performing one of the following actions will be excluded from the frequency setup of another EM:

- Remote (full) scan
- Scan Me / Scan Network -> Autosetup
- Bonding
- TX Sync
- TX Update
- Device Update (if in progress)

To open the Scan / Auto Setup menu item:

▷ In the menu, navigate to the **Scan / Auto Setup** menu item for the desired channel.

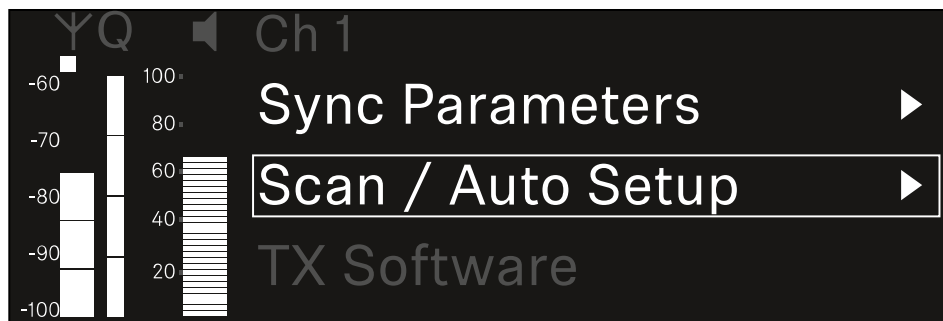

▷ Press the **jog dial** to open the menu.



➔ The following view is displayed:

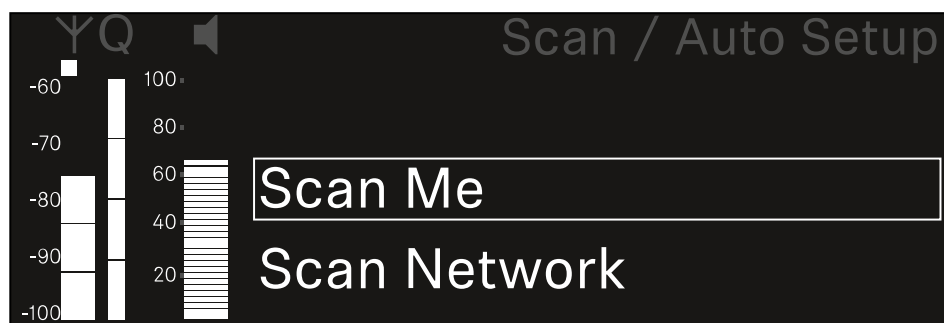

- ▷ Turn the **jog dial** to choose between the **Scan Me** and **Scan Network** options.
 - **Scan Me:** The frequency scan and the frequency setup are performed only for the selected receiving channel.
 - **Scan Network:** The frequency scan and the frequency setup are performed for both channels of the receiver as well as for all other receivers available in the network.
- ▷ Press the **jog dial** to open your selected option.

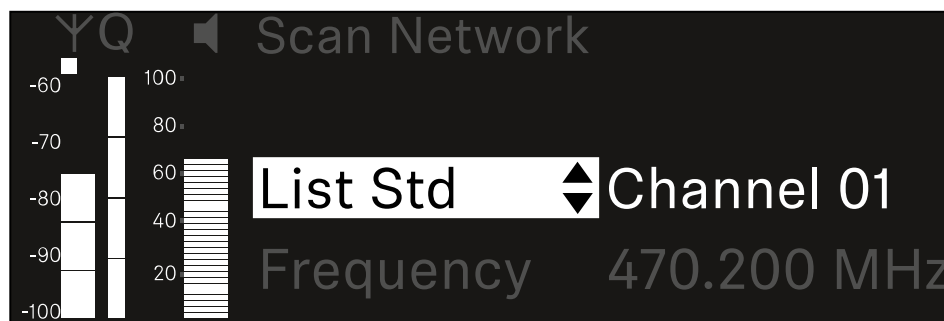

- ▷ Select a frequency from which to start the scan.
- ▷ Press the **jog dial** to start the scan.



➔ The spectrum is scanned for free frequencies above the selected frequency.

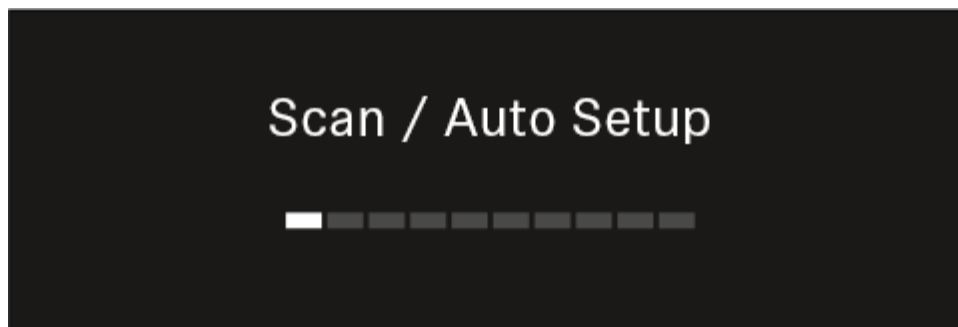

i After the scan free frequencies are displayed, which you can then assign to the channels.

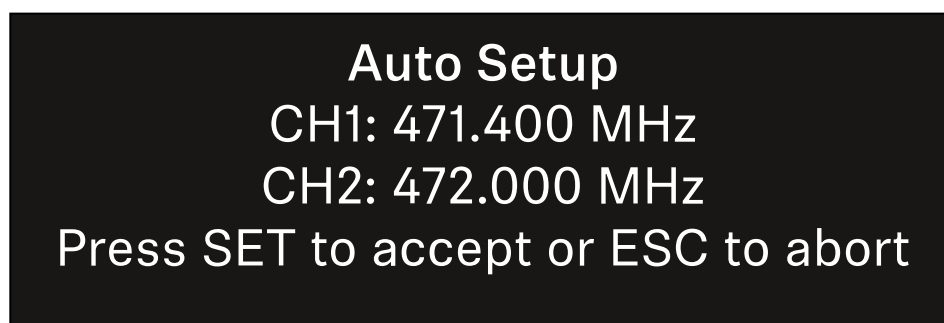

- ▷ Press the **jog dial** to assign the free frequencies to the receiving channels.
Or
- ▷ Press the **ESC** key to cancel and not assign new frequencies.
- ▷ Next, synchronize the receiving channels with the corresponding transmitters to establish the radio link at the new selected frequencies ([Synchronizing the receiver and transmitter](#)).



Ch 1- Ch 4 -> Walktest menu item

The **Walktest** menu item allows the performance of a reception test.

Once you have set up and installed all of the receivers and transmitters for your event, we recommend performing a walk test. This lets you check whether sufficient reception strength is available throughout the entire area used.

Start the walktest function in this menu item and then walk the entire area with one transmitter. The results of the walk test give you information about the reception quality.

Opening the Walktest menu item

- ▷ In the menu, navigate to the **Walktest** menu item for the desired channel.

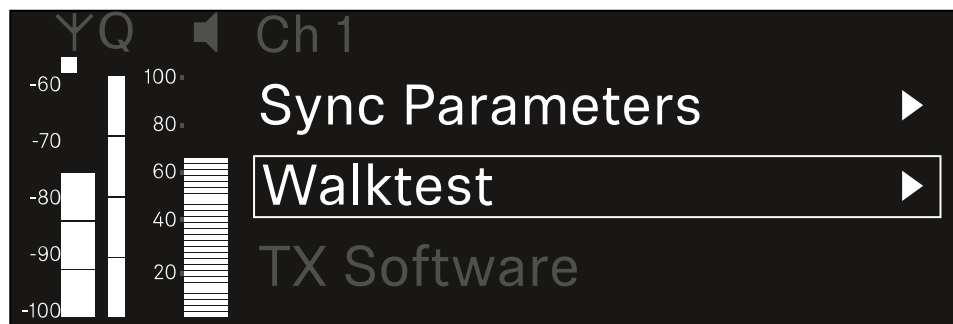

- ▷ Press the **jog dial** to open the menu.

➔ The following view is displayed:



To start the reception test:

- ▷ Press the **jog dial**.
- ▷ Walk the entire area on which you want to operate the system with the transmitter.
 - ➔ The following values are recorded on the display:
 - **RF**: Reception from antenna in dBm
 - **LQI**: Connection quality as a %, see [Meaning of the Link Quality Indicator](#)
 - **AF**: Transmitter audio frequency in dBFS



To end the reception test:

▷ Press the **Jog-Dial** to finish the walk test when you are ready.

YQ	Ch 1	Walktest		
		RF	LQI	AF
•				
•	Max	-92.4	0	-138.5
•	Min	-107.0	0	-138.5

Press SET to stop



Ch 1 - Ch 4 -> TX Software menu item

The **TX Software** menu item displays the software version of the received transmitter.

You cannot open this menu item to make settings.

- ▷ In the menu, navigate to the **TX Software** menu item for the desired channel.

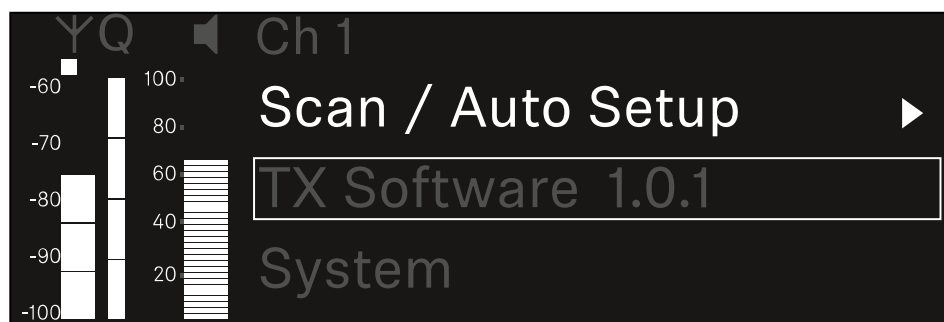

- ➔ The version number of the transmitter software is shown on the display. The transmitter must be switched on for this to be displayed.

i You can find information about updating the transmitter firmware in section [System -> TX Update menu item](#).



System menu item

In the System menu, you can make system-wide settings that will affect the entire device and not only the respective receiving channel.

The following menu items are available:

Encryption

- This menu item lets you secure the radio link with AES 256 encryption.
- [System -> Encryption menu item](#)

Link Density

- In this menu item, you can set the required transmission mode.
- [System -> Link Density menu item](#)

Network

- In this menu item, you can configure the settings for the network connection.
- [System -> Network menu item](#)

TX Update

- This menu item lets you perform a firmware update for the transmitters.
- [System -> TX Update menu item](#)

Auto Setup

- This menu item allows you to activate automatic frequency setup for the receiver.
- [System -> Auto Setup menu item](#)

This Device

- This menu item allows you to enter a device name and display information about the receiver's hardware and software.
- [System -> This Device menu item](#)



System -> Encryption menu item

You can secure the radio link between the transmitter and receiver using AES 256 encryption.

To open the **Encryption** menu item:

- ▷ In the System menu, navigate to the **Encryption** menu item.

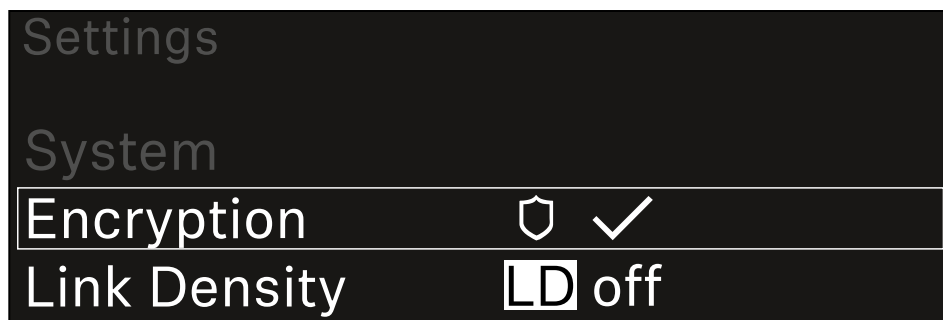

- ▷ Press the **jog dial** to open the menu.

➔ The following view is displayed:

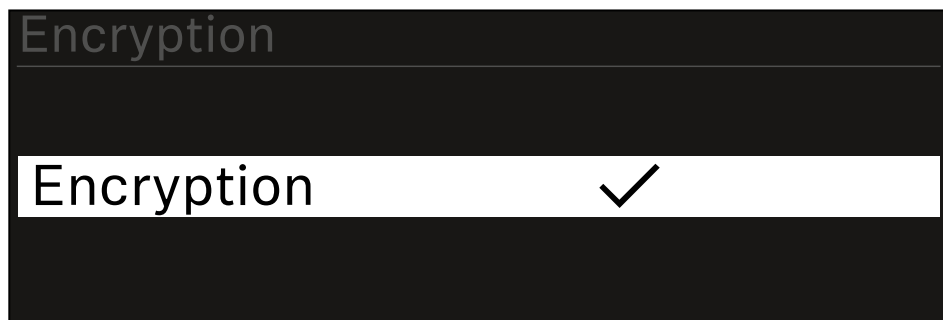

- ▷ Turn the **jog dial** to choose between the **On** and **Off** options.
- ▷ Press the **jog dial** to save your setting.

i After enabling AES 256 encryption, the connected transmitter must be resynchronized with the receiver to enable encryption on the transmitter as well.



System -> Link Density menu item

i Link Density mode (LD mode)

LD mode doubles the number of usable carrier frequencies in the available spectrum, as the minimum distance for the equidistant frequency grid is halved.

This is achieved by reducing the modulation bandwidth of the transmitter. This means that a much smaller frequency spacing between neighboring frequencies can be selected, and therefore more frequencies can be used in the same available spectrum without intermodulation.

LD mode is recommended if the following criteria are met:

- The required number of channels cannot be achieved using the normal mode, as there may be only a small spectrum available.
- The distance between the transmitters and the antennas is not too great.

To open the Link Density menu item:

- ▷ In the System menu, navigate to the **Link Density** menu item.



- ▷ Press the **jog dial** to open the menu.

➔ The following view is displayed:



- ▷ Turn the **jog dial** to choose between the **On** and **Off** options.



- ▷ Press the **jog dial** to save your setting.
 - ➔ If you have enabled LD mode, the receiver must be restarted.

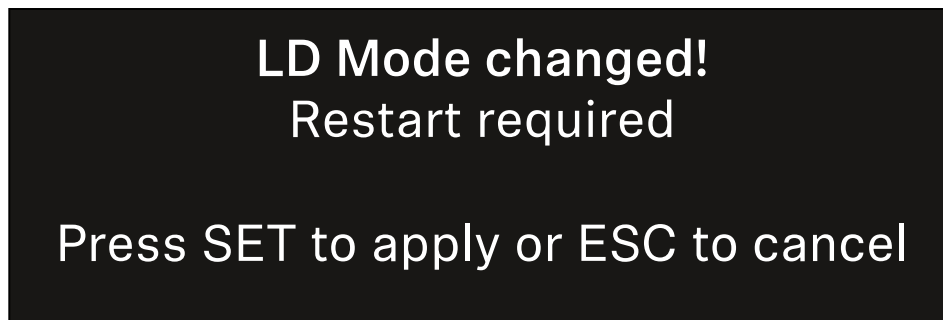

- ▷ Press the **jog dial** to restart the receiver.
 - Or
- ▷ Press the **ESC** button to cancel the mode change.

i After enabling LD mode and restarting the receiver, the connected transmitter must be resynchronized with the receiver to enable LD mode on the transmitter as well.



System -> Network menu item

In this menu item, you can configure the settings for the network connection.

To open the **Network** menu item:

- ▷ In the System menu, navigate to the **Network** menu item.

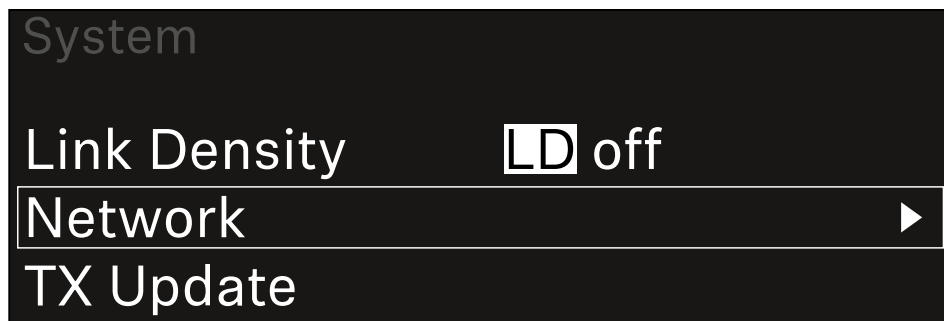

- ▷ Rotate the **jog dial** to navigate through the **Network** menu and select the desired menu item.

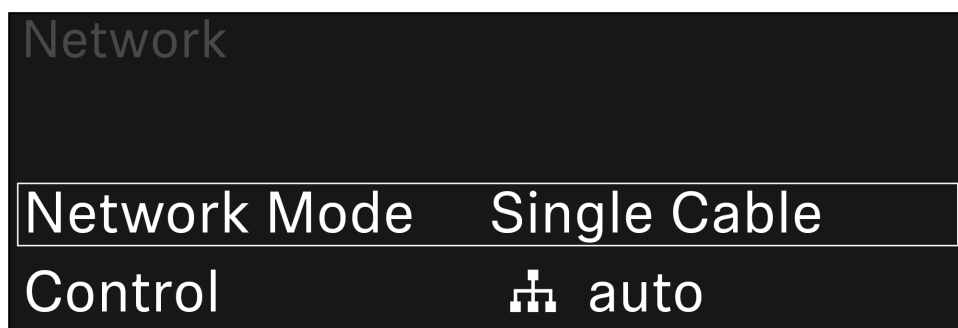



➔ You can make the following settings here:

Network Mode

- Single Cable
- Split
- Redundancy

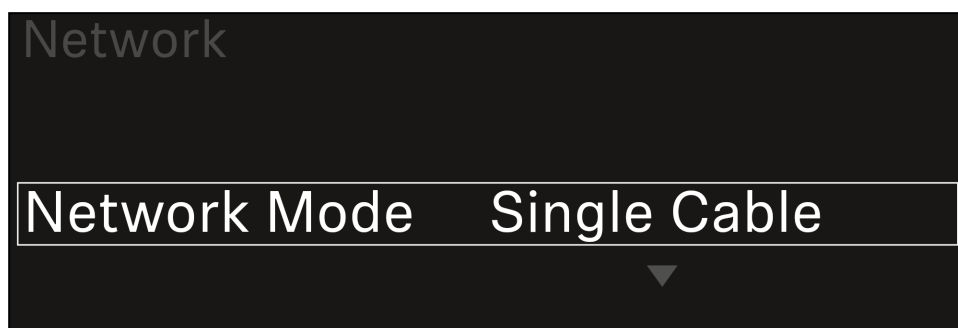

i See [Connecting receivers in a Dante® network.](#)

Control

- Mode
 - **Auto:** The network configuration is performed automatically.
 - **Manual:** The network configuration can be performed manually.
- mDNS
 - You can enable or disable this option if you want to use mDNS for automatic device detection in the network.
- IP
 - If the **Mode** option is set to **Auto**, the automatically assigned IP address is displayed here.
 - If the **Mode** option is set to **Manual**, you can set the IP address here.
- Netmask
 - If the **Mode** option is set to **Auto**, the automatically assigned netmask is displayed here.
 - If the **Mode** option is set to **Manual**, you can set the netmask here.
- Gateway
 - If the **Mode** option is set to **Auto**, the automatically assigned gateway is displayed here.
 - If the **Mode** option is set to **Manual**, you can set the gateway here.



Dante - Dante Primary and Dante Secondary

- Mode
 - **Auto:** The network configuration is performed automatically.
 - **Manual:** The network configuration can be performed manually.
- mDNS
 - You can enable or disable this option if you want to use mDNS for automatic device detection in the network.
- IP
 - If the **Mode** option is set to **Auto**, the automatically assigned IP address is displayed here.
 - If the **Mode** option is set to **Manual**, you can set the IP address here.
- Netmask
 - If the **Mode** option is set to **Auto**, the automatically assigned netmask is displayed here.
 - If the **Mode** option is set to **Manual**, you can set the netmask here.
- Gateway
 - If the **Mode** option is set to **Auto**, the automatically assigned gateway is displayed here.
 - If the **Mode** option is set to **Manual**, you can set the gateway here.

To save the settings you have made:

- ▷ Turn the **jog dial** until **Apply** appears in the selection frame.

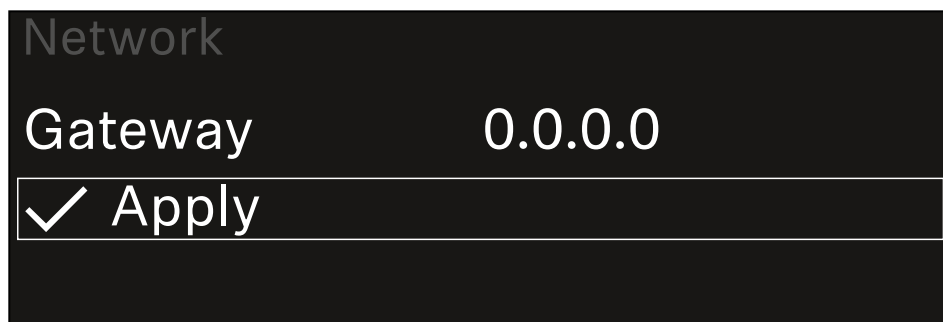

- ▷ Press the **jog dial** to save your settings.



System -> TX Update menu item

This menu item lets you perform a firmware update for the transmitters. This update is recommended after you perform a firmware update for the receiver (see [Updating the firmware of the receiver](#)).

- i** The firmware versions currently installed on the connected transmitter can be viewed under the TX Software menu item for the respective channel (see [Ch 1 - Ch 4 -> TX Software menu item](#)).

To open the TX Update menu item:

- ▷ In the System menu, navigate to the **TX Update** menu item.

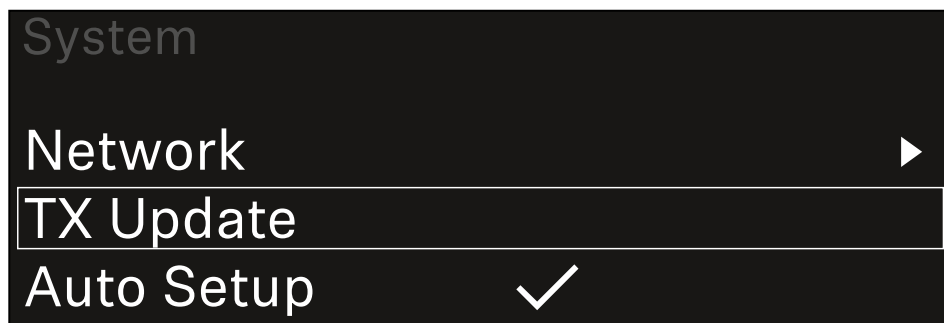

- ▷ Press the **jog dial** to open the menu.
 - ➔ The available sender firmware is displayed:

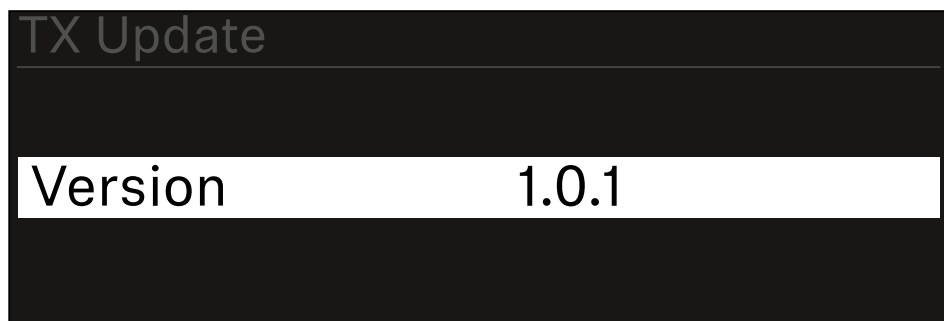



- ▷ Press the **jog dial** to start the firmware update.

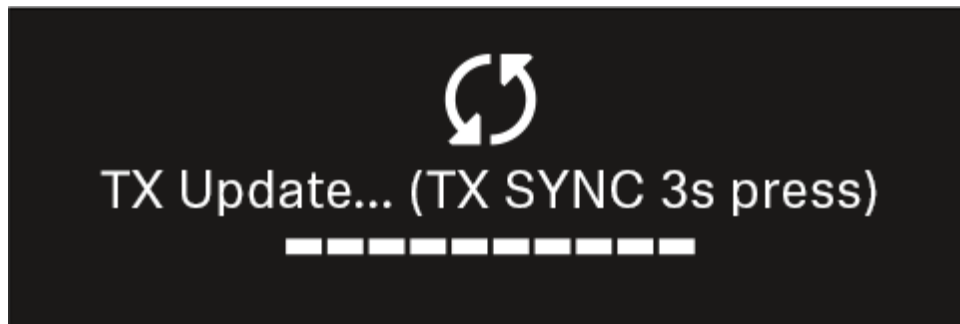

- ▷ Press the **SYNC** button on the connected transmitter for 3 seconds.
 - ➔ You have about 20 seconds to do this. The progress bar shows the remaining time.

The system carries out the firmware update for the transmitter.

The progress of the update is shown on the receiver's display.

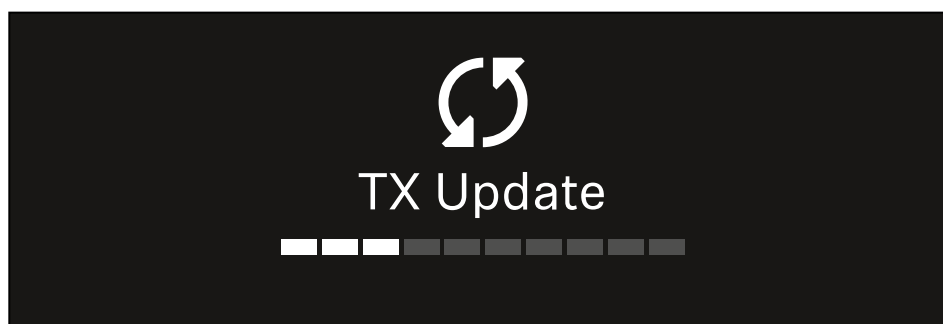

The transmitter's display shows that the firmware update is in progress.

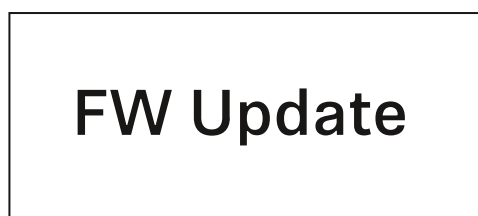



NOTICE



Canceling the update can impair the function of the transmitter

If the transmitter is turned off during the firmware update, the update may fail and the transmitter may cease to function correctly.

- ▷ Do not turn off the transmitter during the update.
- ▷ Do not remove the batteries or rechargeable battery pack during the update.
- ▷ Make sure that the transmitter's (rechargeable) batteries are sufficiently charged before updating.



System -> Auto Setup menu item

In this menu item, you can activate the **Auto Setup** function for the receiver.

If the function is activated here, you can perform an automatic frequency setup for both channels of this receiver via the **Scan / Auto Setup** menu item.

See [Ch 1 - Ch 4 -> Scan/Auto Setup menu item](#).

The receiver will also be enabled for automatic frequency setup in a network consisting of multiple receivers.

If the function is disabled here, you can only assign a frequency to the selected channel of the receiver via the **Scan / Auto Setup** menu item.

To open the Auto Setup menu item:

- ▷ In the System menu, navigate to the **Auto Setup** menu item.

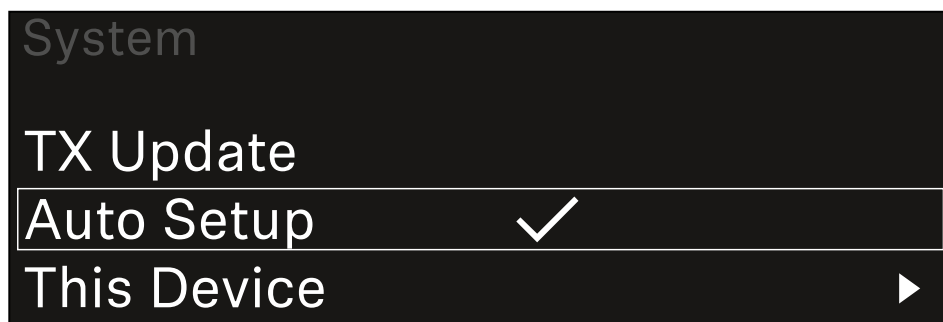

- ▷ Press the **jog dial** to open the menu.

➔ The following view is displayed:

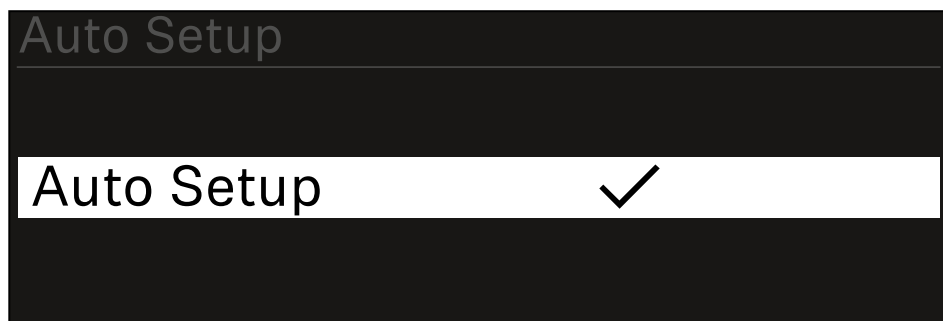

- ▷ Turn the **jog dial** to choose between the **On** and **Off** options.
- ▷ Press the **jog dial** to save your setting.



System -> This Device menu item

This menu item allows you to change the device name, view software and hardware information, or reset the device to factory settings.

To open the **This Device** menu item:

- ▷ In the System menu, navigate to the **This Device** menu item.

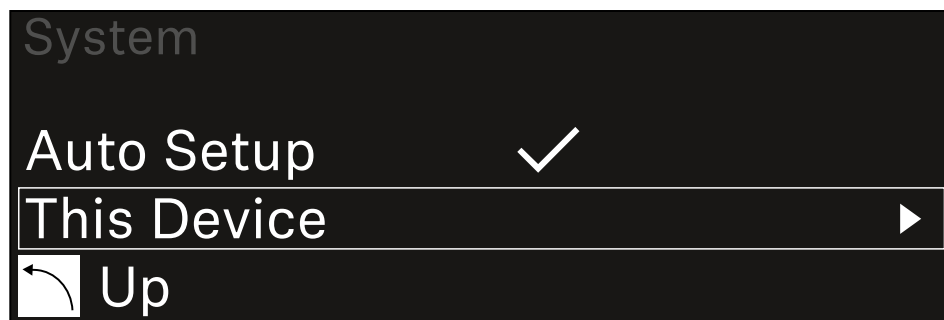

- ▷ Press the **jog dial** to open the menu.

➔ The following view is displayed:



- ▷ Choose from the following:
 - **Booster Feed:** Set the power supply for an external antenna amplifier
 - **Device Lock:** Set the lock-off of the receiver.
 - **Brightness:** Set the brightness of the display.
 - **Device Name:** Open this menu item to change the device name. This receiver will be displayed in the network under this name.
 - **MAC:** Shows the MAC address of the receiver.
 - **Dante Name:** Shows the name of the device in the Dante network.
 - **Dante Pri MAC/Dante Sec MAC:** Shows the primary/secondary Dante MAC address of the receiver
 - **Software:** Shows the software version of the receiver.
 - **HW Main/HW Front/HW Tuner1/HW Tuner 2/HW Interface:** Displays the hardware versions of the boards installed in the receiver.
 - **Reset:** Resets the receiver to factory settings.



Updating the firmware of the receiver

You can update the receiver firmware using the **Sennheiser Control Cockpit** software, the **Wireless Systems Manager** software or the **Smart Assist** app.

Updating with the Sennheiser Control Cockpit or the Wireless Systems Manager:

- ▷ Connect the receiver to a network (see [Connecting receivers in a network](#)) and establish the connection with the software.

i For more information about controlling devices with the **Sennheiser Control Cockpit** or **Wireless Systems Manager** software, refer to the software help.

You can download the software here:

sennheiser.com/control-cockpit-software

sennheiser.com/wsm

i To update the transmitter's firmware, go to System -> TX Update in the menu on the receiver. See [System -> TX Update menu item](#)

Updating with the Smart Assist app:

- ▷ Connect the receiver to a network (see [Connecting receivers in a network](#)).
- ▷ Connect a wireless access point to the network.
- ▷ Connect your smartphone to this network.
- ▷ Start the update process in the **Smart Assist** app:
- ▷ Click on "Update" if the device is on the network.
- ▷ Follow the instructions.
- Or
- ▷ Search for devices that can be updated.
- ▷ Follow the instructions.



EW-DX SKM | EW-DX SKM-S handheld transmitter

Product overview

Inserting and removing the batteries/rechargeable batteries

Replacing the microphone module

Switching the handheld transmitter on and off

Checking the battery status of the transmitter (Check function)

Identifying the paired receiver (Identify function)

Meaning of the LEDs

Establishing a connection to the receiver

Information on the handheld transmitter's display

Buttons for navigating the menu

Opening the menu and navigating the menu items

Name menu item

Frequency menu item

Low Cut menu item

Trim menu item

Test Tone menu item

Mute Button menu item

Auto Lock menu item

Brightness menu item

LED menu item

This Device menu item

Lock-off function

Configuring mute mode and muting the handheld transmitter (EW-DX SKM-S only)

Updating the firmware of the transmitter

Product overview

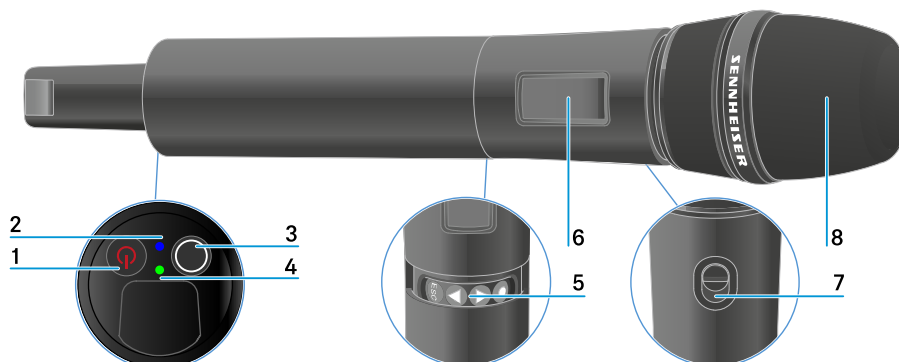



1 ON/OFF button

- See [Switching the handheld transmitter on and off](#)

2 DATA LED

- See [Meaning of the LEDs](#)

3 SYNC button

- See [Establishing a connection to the receiver](#)

4 LINK LED

- See [Meaning of the LEDs](#)

5 Function buttons for navigating the menu

- See [Buttons for navigating the menu](#)

6 Display panel

- See [Information on the handheld transmitter's display](#)

7 Mute switch (EW-DX SKM-S only)

- See [Configuring mute mode and muting the handheld transmitter \(EW-DX SKM-S only\)](#)

8 Microphone module

- See [Replacing the microphone module](#)



Inserting and removing the batteries/rechargeable batteries

You can operate the handheld transmitter either with batteries (AA, 1.5 V) or with the rechargeable Sennheiser BA 70 battery.

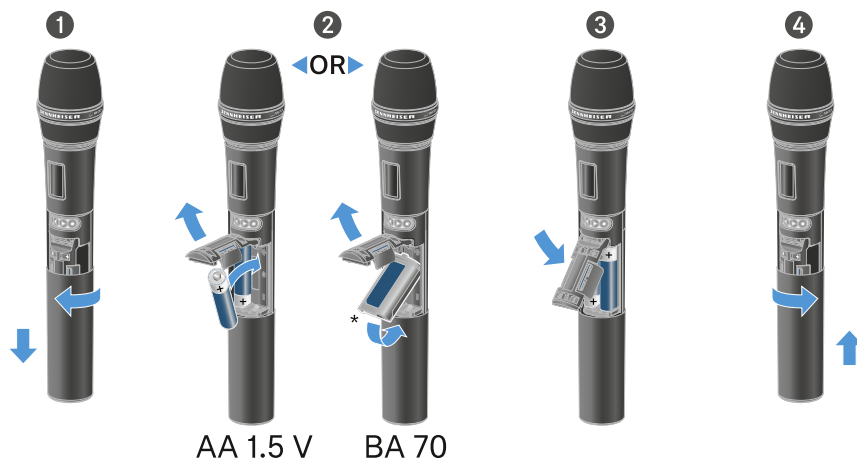

- ▷ Unscrew the microphone housing as shown in the figure and pull it down as far as it will go.
- ▷ Insert the batteries or the BA 70 rechargeable battery as indicated in the battery compartment. Observe correct polarity.
- ▷ Screw the microphone housing back on.



Note about the BA 70 rechargeable battery

- Make sure that the BA 70 rechargeable battery is inserted as follows:

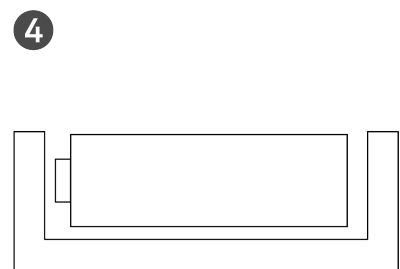
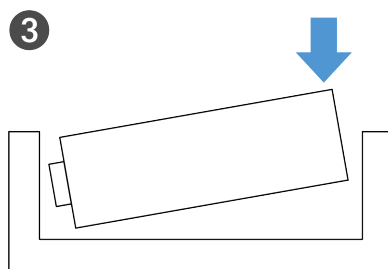
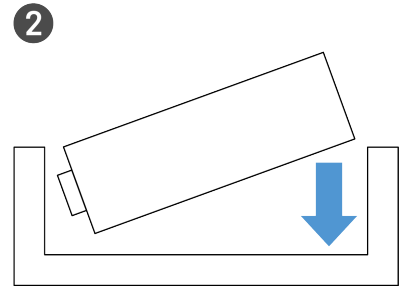
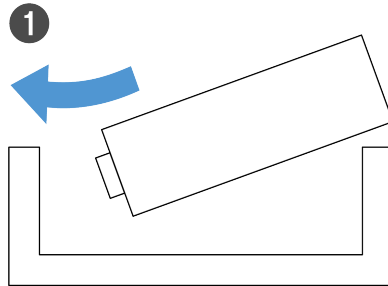



Replacing the microphone module

To replace the microphone module:

- ▷ Unscrew the microphone module.
- ▷ Screw the desired microphone module on.
- ▷ Do not touch the wireless microphone contacts or the microphone module contacts. If you touch the contacts, they may become dirty or bent.



Compatible microphone modules



The following microphone modules are compatible with the handheld transmitter:

- **MMD 835-1** | Dynamic microphone module with cardioid pattern
- **MMD 845-1** | Dynamic microphone module with super-cardioid pick-up pattern
- **MME 865-1** | Condenser microphone module with super-cardioid pick-up pattern
- **MMD 935-1** | Dynamic microphone module with cardioid pattern
- **MMD 945-1** | Dynamic microphone module with super-cardioid pick-up pattern
- **MMK 965-1** | Condenser microphone module with selectable pattern: cardioid and super-cardioid
- **MMD 42-1** | Dynamic microphone module with omni-directional pattern
- **Neumann KK 204** | Condenser microphone module with cardioid pattern
- **Neumann KK 205** | Condenser microphone module with super-cardioid pick-up pattern
- **MM 435** | Dynamic microphone module with cardioid pattern
- **MM 445** | Dynamic microphone module with super-cardioid pick-up pattern
- **ME 9002** | Condenser microphone module with omni-directional pattern
- **ME 9004** | Condenser microphone module with cardioid pattern
- **ME 9005** | Condenser microphone module with super-cardioid pick-up pattern



Switching the handheld transmitter on and off

To switch the handheld transmitter on:

- ▷ Short-press the **ON/OFF** button.
 - ➔ The **LINK** LED lights up and the transmitter switches on.

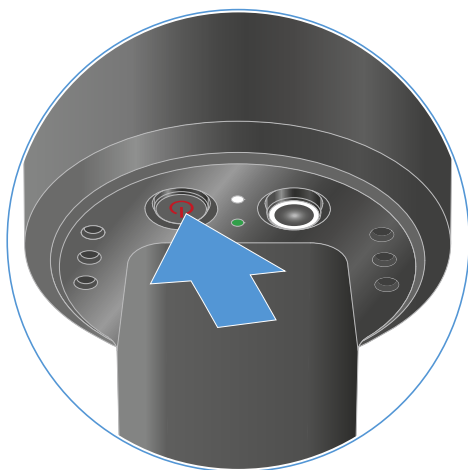

To switch the handheld transmitter off:

- ▷ Hold down the **ON/OFF** button until the LEDs switch off.

- i** Note that the transmitter's permanent E-Ink display still displays the parameters after it is switched off.

Display when transmitter is switched on:

```
EW-DX 1  
510.100
```

Display when transmitter is switched off:

```
EW-DX 1  
510.100  
off
```



Checking the battery status of the transmitter (Check function)

Checking the battery status of the transmitter

- ▷ Short-press the **ON/OFF** button on the transmitter.

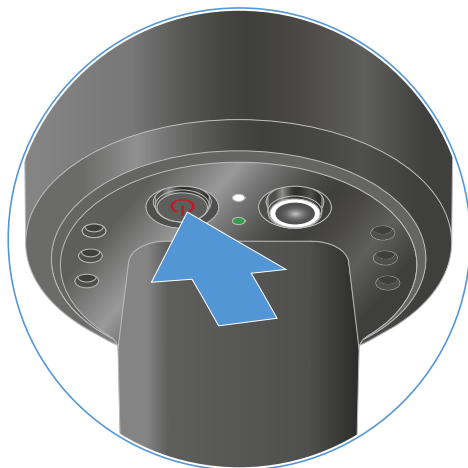

- ➔ The transmitter's **LINK LED** flashes to indicate the current charge level of the battery or the BA 70 rechargeable battery.

LINK LED	
	≤ 100 %
	≤ 60 %
	≤ 20 %

In addition, the battery status is displayed on the transmitter display for approx. 5 seconds.



- i** Pressing the transmitter's **ON/OFF** button will simultaneously trigger the Identify function: [Identifying the paired receiver \(Identify function\)](#).



Identifying the paired receiver (Identify function)

In multi-channel systems, you can use the **Check** function to quickly identify to which receiver the transmitter is paired.

Both the transmitter and receiver must be switched on.

- ▷ Short-press the **ON/OFF** button on the transmitter.

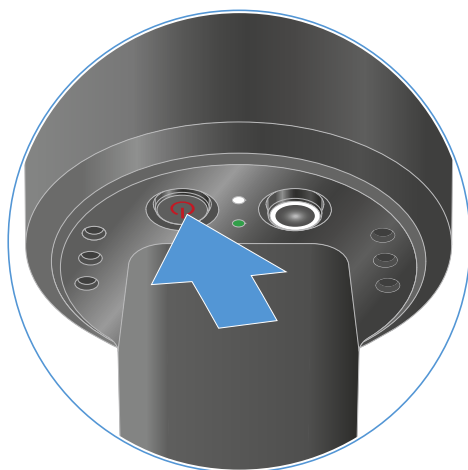

- ➔ An eye flashes next to the respective receiving channel on the coupled receiver's display.

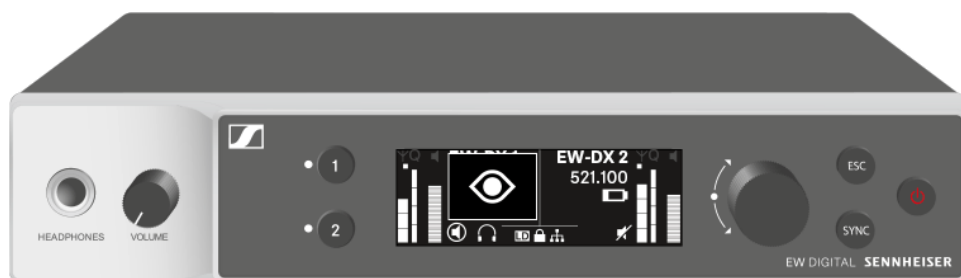

- i** Pressing the transmitter's ON/OFF button will simultaneously trigger the Check function: [Checking the battery status of the transmitter \(Check function\)](#).



Meaning of the LEDs

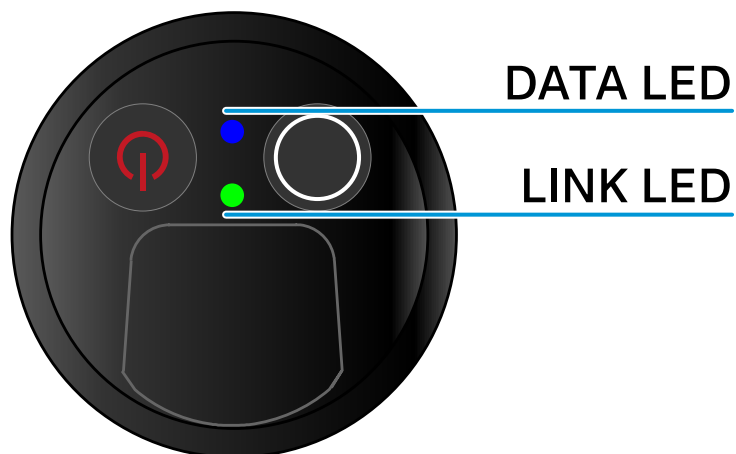

The **LINK** and **DATA** LEDs on the bottom of the transmitter can indicate the following information.

LINK LED

The **LINK** LED provides information about the status of the radio link between the transmitter and receiver, as well as status information for the paired transmitter.



The LED is green:



- The link between the transmitter and receiver is established.
- The transmission frequency is active.

The LED is yellow:



- The link between the transmitter and receiver is established.
- The audio signal is muted or
- No microphone module is mounted on the SKM-S handheld transmitter.

The LED is flashing yellow:



- The link between the transmitter and receiver is established.
- The audio signal is overdriven (clipping).

The LED is continuously red:



- The (rechargeable) battery in the transmitter is dead.

The LED is flashing red:



- The link between the transmitter and receiver is established.
- The battery/rechargeable battery in the transmitter is low.

The LED is off:



- No link between the transmitter and receiver.
- The transmitter is switched off.



DATA LED

The **DATA** LED provides information about the synchronization of transmitters and receivers.

The LED is flashing blue:



- The transmitter is being synchronized with a receiver.

The LED is blue:



- The firmware is being updated.

The LED is off:



- There is currently no active data link.
-



Establishing a connection to the receiver

To establish a radio link between the transmitter and the receiver, the devices must be synchronized.

See [Establishing a radio link | Synchronizing the receiver and transmitter](#)

i Conditions and restrictions for using frequencies

There may be special conditions and restrictions for using frequencies in your country.

Before putting the product into operation, find the information for your country at the following address:

sennheiser.com/sifa



Information on the handheld transmitter's display

You can view the following information on the transmitter display.

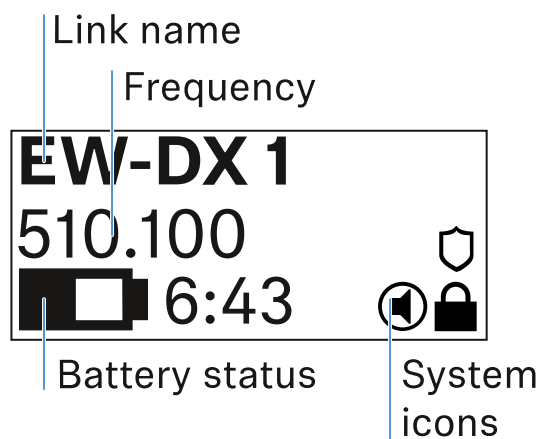

Link name

- You can assign a name to the radio link in the transmitter's menu (see [Name menu item](#)).
- Alternatively, you can assign the name in the receiver's menu and then synchronize it to the transmitter (see [Ch 1 / Ch 2 -> Name menu item](#)).

Frequency

- You can manually set the frequency of the radio link in the transmitter's menu (see [Frequency menu item](#)).
- The frequency of the radio link can also be set manually in the receiver's menu (see [Ch 1 / Ch 2 -> Frequency menu item](#)) or via the **Auto Setup** function (see [Ch 1 / Ch 2 -> Scan / Auto Setup menu item](#)) and then synchronized to the transmitter.



Battery status

- Displays the charging status of the batteries or the BA 70 battery pack.
- When using the BA 70 rechargeable battery, the remaining runtime is also displayed in hours and minutes.
- The battery status is hidden in the display's default state. Short-press the **On/Off** button on the transmitter (Check function, see [Checking the battery status of the transmitter \(Check function\)](#)) to display the battery status for approx. 5 seconds.



System icons



The transmitter's mute switch is deactivated. See [Mute Button menu item](#).



The Auto Lock function is activated. See [Auto Lock menu item](#).



AES 256 encryption is enabled. See [System -> Encryption menu item](#).

i Note that the transmitter's permanent E-Ink display still displays the parameters after it is switched off.

Display when transmitter is switched on:

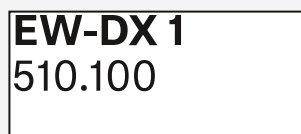

Display when transmitter is switched off:

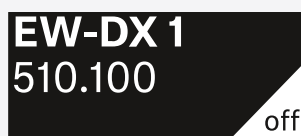



Buttons for navigating the menu

Use the following buttons to navigate through the transmitter's operating menu.

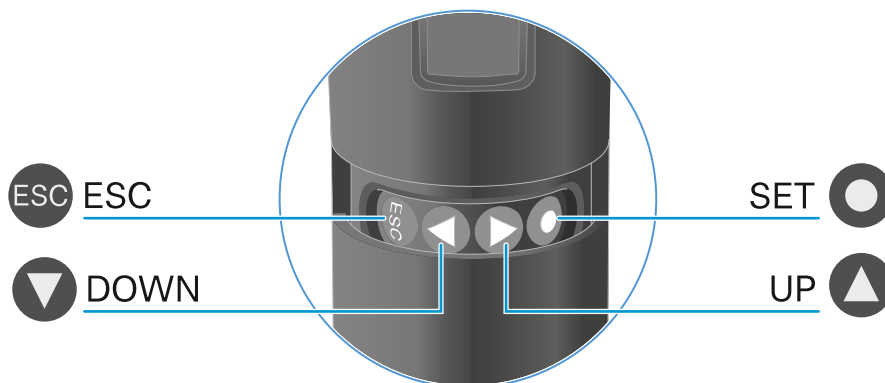

Press the **SET** button



- Jumps from the home screen to the operating menu
- Calls up a menu item
- Saves settings

Press the **UP** or **DOWN** button



- Changes to the previous or next menu item
- Changes the setting of a menu item

Press the **ESC** button



- Cancels the entry and returns to the previous display

i [Opening the menu and navigating the menu items](#)



Opening the menu and navigating the menu items

Navigating through the menu and making changes in a menu item

To open the menu:

- ▷ Press the **SET** button.
 - ➡ The operating menu is shown on the transmitter display panel.

To open a menu item:

- ▷ Press the **UP** or **DOWN** buttons to navigate through the individual menu items.
- ▷ Press the **SET** button to open the selected menu item.

To make changes in a menu item:

- ▷ Press the **UP** or **DOWN** buttons to set the displayed value.
- ▷ Press the **SET** button to save the setting.
- ▷ Press the **ESC** button to leave the menu item without saving the setting.

Related information

[Name menu item](#)
[Frequency menu item](#)
[Low Cut menu item](#)
[Trim menu item](#)
[Test Tone menu item](#)
[Mute Button menu item](#)
[Auto Lock menu item](#)
[Brightness menu item](#)
[LED menu item](#)
[This Device menu item](#)

Name menu item

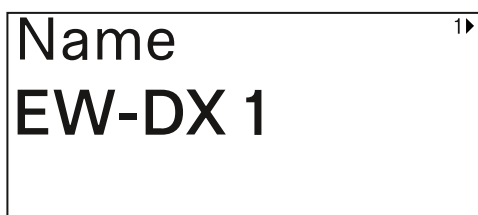



You can enter the name of the link in this menu item.



- ▷ Press the **UP** or **DOWN** buttons to select a character.
- ▷ Press the **SET** button to go to the next position.
- ▷ At the last position, press the **SET** button to save the selected name.

i If you enter a name for the radio link in the **Name** menu item on the receiver and then synchronize the receiving channel with the transmitter, the name entered in the transmitter is overwritten with the name entered in the receiver.



Frequency menu item

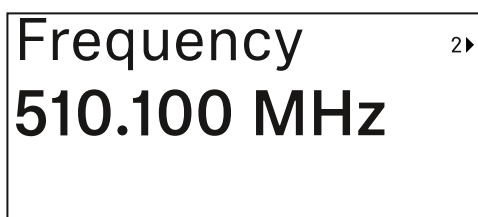

In this menu item, you can set the transmitter's transmission frequency.



- ▷ Press the **UP** or **DOWN** button to set the frequency's MHz range.
- ▷ Press the **SET** button to confirm your selection.

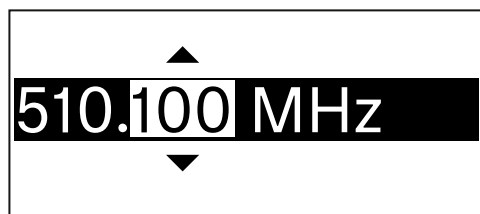

- ▷ Press the **UP** or **DOWN** button to set the frequency's kHz range.
- ▷ Press the **SET** button to save the set frequency.

i If you set a frequency for the channel using the **Frequency** menu item on the receiver or via the **Scan / Auto Setup** function and then synchronize the receiving channel with the transmitter, the frequency entered in the transmitter is overwritten by the frequency set in the receiver.



Low Cut menu item

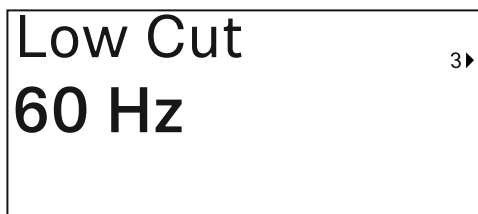

In this menu item, you can adjust the value for the low cut filter.

- Setting range: 60 Hz, 80 Hz, 100 Hz, 120 Hz

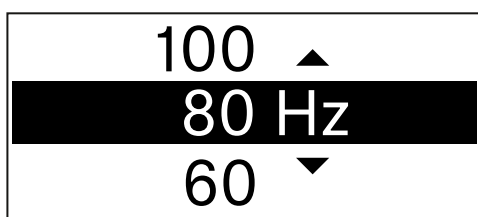

- ▷ Press the **UP** or **DOWN** button to set the desired value.
- ▷ Press the **SET** button to confirm your selection.

i If you set a value for the channel's low cut filter using the **Low Cut** menu item on the receiver and then synchronize the receiving channel with the transmitter, the value entered in the transmitter is overwritten by the value set in the receiver.



Trim menu item

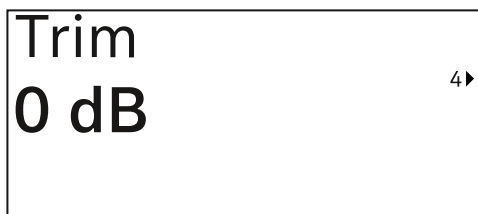

In this menu item, you can adjust the audio level of the transmitter as well as the gain of the wireless link (can be set only on the receiver) to suit input signals of different volumes.

- Setting range: **-12 dB** to **+6 dB** in increments of 1 dB

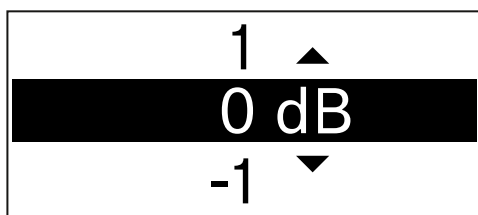

- ▷ Press the **UP** or **DOWN** button to set the desired value.
- ▷ Press the **SET** button to confirm your selection.

i If you set a value for the channel in the **Trim** menu item on the receiver and then synchronize the receiving channel with the transmitter, the value entered in the transmitter is overwritten with the value entered in the receiver.



Test Tone menu item

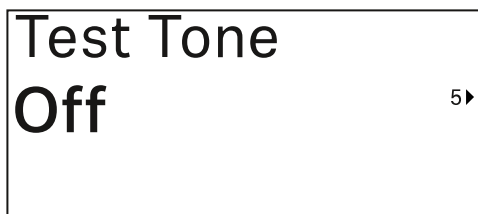

In this menu item, you can activate a test tone that the transmitter transmits instead of the input signal. You can use this feature to level out the system, for example.

- Setting range: **Off**, **-90 dB** to **0 dB** in 6 dB increments



- ▷ Press the **UP** or **DOWN** button to set the desired value.
- ▷ Press the **SET** button to confirm your selection.



Mute Button menu item



- i** This function is only available for the EW-DX SKM-S version, not for the EW-DX SKM version.

In this menu item you can set the function of the transmitter's mute switch.

Setting range:

- **Disabled:** The mute switch has no function.
- **RF Mute:** The RF signal is deactivated when the mute switch is on.
- **AF Mute:** The audio signal is muted when the mute switch is on.



- ▷ Press the **UP** or **DOWN** button to set the desired value.
- ▷ Press the **SET** button to confirm your selection.

- i** If you set a function for the transmitter's mute switch in the **Mute Mode** menu item on the receiver and then synchronize the receiving channel with the transmitter, the value entered in the transmitter is overwritten with the value entered in the receiver.



Auto Lock menu item



In this menu item, you can activate or deactivate the automatic lock-off for the transmitter.

The lock-off prevents the transmitter from being unintentionally switched off and also prevents any changes to the transmitter's menu.

- i** The lock-off prevents the transmitter from being unintentionally switched off and also prevents any changes to the transmitter's menu. See [Lock-off function](#).



- ▷ Press the **UP** or **DOWN** button to set the desired value.
- ▷ Press the **SET** button to confirm your selection.

- i** If you set a value for the transmitter's automatic lock-off in the **Auto Lock** menu item on the receiver and then synchronize the receiving channel with the transmitter, the value entered in the transmitter is overwritten with the value entered in the receiver.



Brightness menu item



In this menu item, you can adjust the brightness of the transmitter's display.

You can turn off the backlight completely or set it to one of five brightness levels.



- ▷ Press the **UP** or **DOWN** button to set the desired value.
- ▷ Press the **SET** button to confirm your selection.



LED menu item



This menu item allows you to set the behavior of the transmitter's LINK LED.

Setting range:

- **ON:** The LINK LED remains continuously lit.
- **OFF:** The LINK LED switches off while the lock-off function is active.

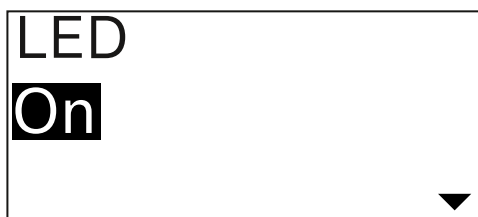

- ▷ Press the **UP** or **DOWN** button to set the desired value.
- ▷ Press the **SET** button to confirm your selection.

i If you set a function for the transmitter's LINK LED in the **LED** menu item on the receiver and then synchronize the receiving channel with the transmitter, the value entered in the transmitter is overwritten with the value entered in the receiver.



This Device menu item



In this menu item you can view information about the transmitter's software and hardware and reset the transmitter to the factory settings.

Show software

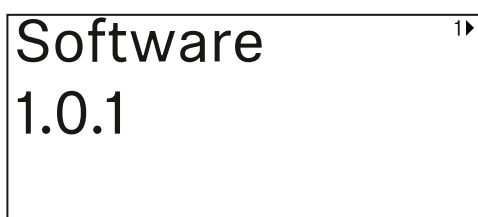

Show hardware

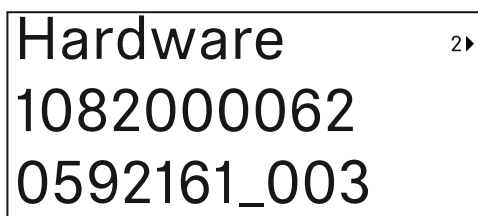

Reset to factory settings

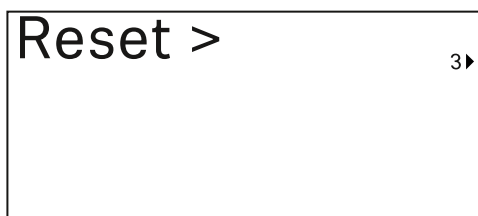



- ▷ Press the **SET** button to open the Reset menu item.



- ▷ Press the **UP** or **DOWN** button to set the desired value.
- ▷ Press the **SET** button to confirm your selection.



Lock-off function

You can enable or disable the automatic lock-off function in the **Auto Lock** menu item (see [Auto Lock menu item](#)).

The lock-off function prevents the transmitter from being unintentionally switched off and also prevents any unintentional changes to the transmitter's configuration.

If you have enabled the **Auto Lock** function, you will have to temporarily deactivate the lock-off function to operate the transmitter.

To temporarily deactivate the lock-off function:

- ▷ Press the **SET** button.
 - ➔ Locked appears in the display panel.
- ▷ Press the **UP** or **DOWN** button.
 - ➔ Unlock? appears in the display panel.
- ▷ Press the **SET** button.
 - ➔ Lock-off function is now temporarily deactivated.

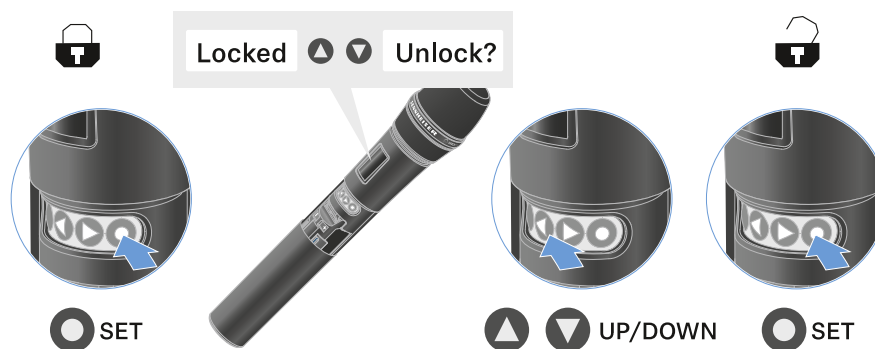

- ✓ The lock-off function remains deactivated while you are actively working in the operating menu.

i After 10 seconds of inactivity, it automatically activates again.



Configuring mute mode and muting the handheld transmitter (EW-DX SKM-S only)

i This function is only available for the EW-DX SKM-S version, not for the EW-DX SKM version.

You can mute the handheld transmitter by using the mute switch to turn off either the audio signal (**AF Mute**) or the RF signal (**RF Mute**).

To do this, you must configure the function of the mute switch in the **Mute Mode** menu item.

- On the receiver: [Ch 1 / Ch 2 -> Mute Mode menu item](#)
- On the transmitter: [Mute Button menu item](#)

AF Mute

▷ Slide the mute switch to the desired position to mute or activate the audio signal.

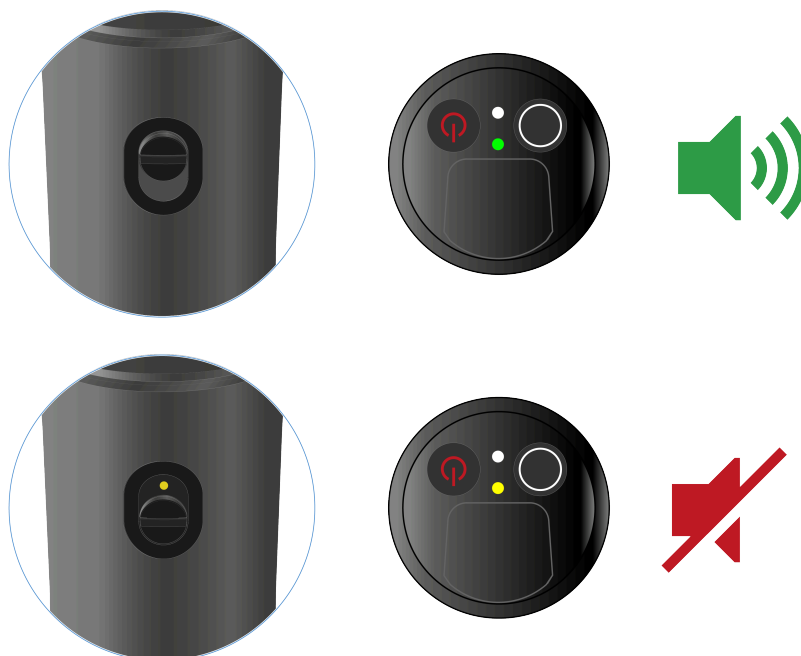



RF Mute

▷ Slide the mute switch to the desired position to activate or deactivate the RF signal.

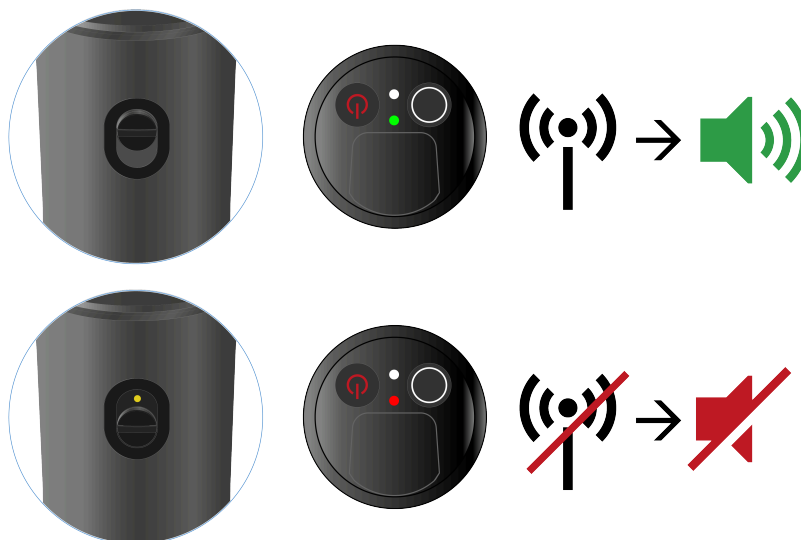



Updating the firmware of the transmitter

The transmitter firmware is updated via the receiver.

- ▷ Update the transmitter firmware using the **TX Update** menu item in the receiver's System menu. See [Ch 1 / Ch 2 -> TX Software menu item](#).



EW-DX SK | EW-DX SK 3-PIN bodypack transmitter

- Product overview
- Inserting and removing the batteries/rechargeable batteries
- Connecting a microphone to the bodypack transmitter
- Connecting an instrument or line source to the bodypack transmitter
- Changing the belt clip
- Switching the bodypack transmitter on and off
- Checking the battery status of the transmitter (Check function)
- Identifying the paired receiver (Identify function)
- Meaning of the LEDs
- Establishing a connection to the receiver
- Information on the bodypack transmitter's display
- Buttons for navigating the menu
- Opening the menu and navigating the menu items
- Name menu item
- Frequency menu item
- Low Cut menu item
- Trim menu item
- Cable Emulation menu item
- Test Tone menu item
- Mute Button menu item
- Auto Lock menu item
- Brightness menu item
- LED menu item
- This Device menu item
- Lock-off function
- Configuring mute mode and muting the bodypack transmitter
- Updating the firmware of the transmitter



Product overview

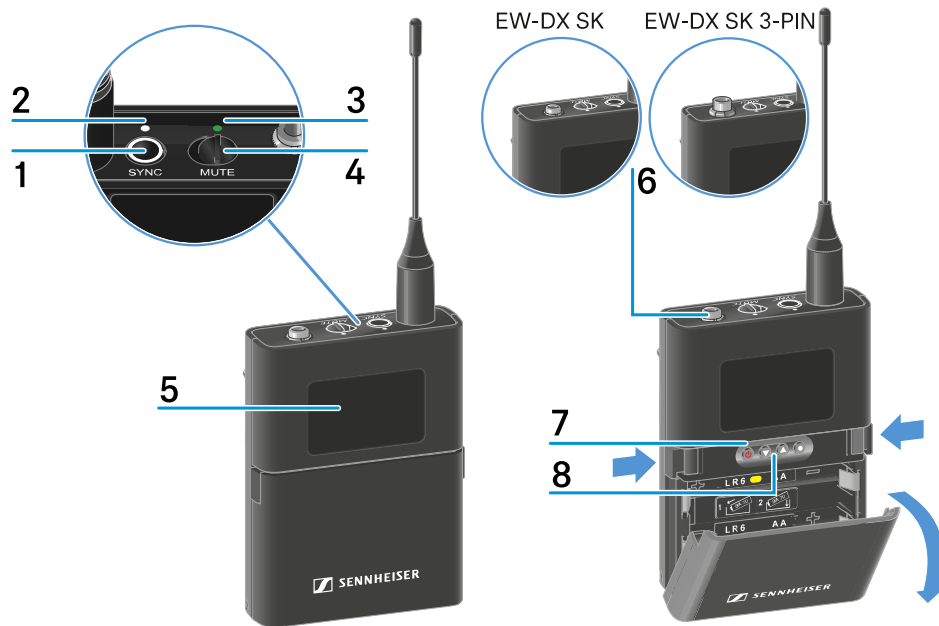

1 SYNC button

- See [Establishing a radio link | Synchronizing the receiver and transmitter](#)

2 DATA LED

- See [Meaning of the LEDs](#)

3 LINK LED

- See [Meaning of the LEDs](#)

4 Mute switch

- See [Configuring mute mode and muting the bodypack transmitter](#)

5 Display panel

- See [Information on the bodypack transmitter's display](#)

6 EW-DX SK: 3.5 mm jack socket



EW-DX SK 3-PIN: 3-pin socket

- See [Connecting a microphone to the bodypack transmitter](#)
- See [Connecting an instrument or line source to the bodypack transmitter](#)

7 ON/OFF button

- See [Switching the bodypack transmitter on and off](#)

8 Function buttons for navigating the menu

- See [Buttons for navigating the menu](#)



Inserting and removing the batteries/rechargeable batteries

You can operate the handheld transmitter either with batteries (AA, 1.5 V) or with the rechargeable Sennheiser BA 70 battery.

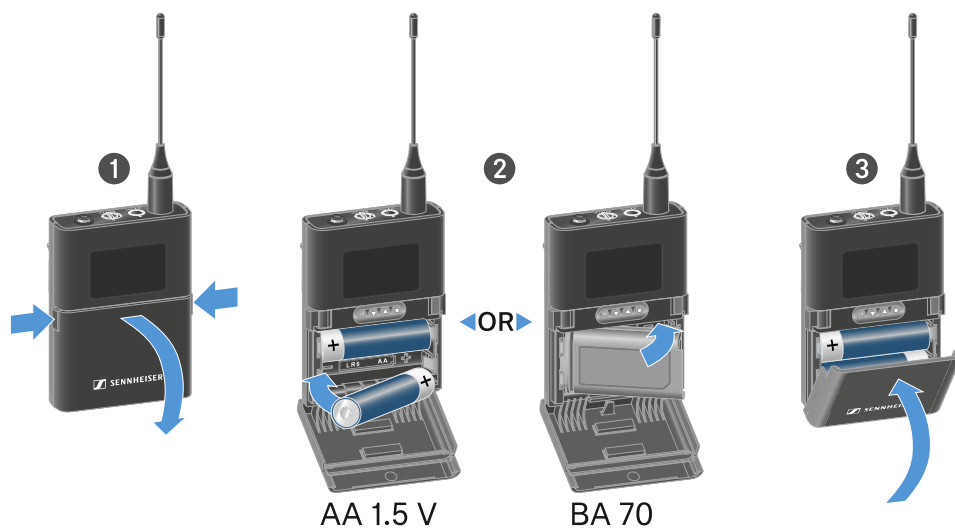

- ▷ Press the two catches and open the battery compartment cover.
- ▷ Insert the batteries or the BA 70 rechargeable battery as indicated in the battery compartment. Observe correct polarity.
- ▷ Close the battery compartment.
 - ➔ The cover locks into place with an audible click.



Note about the BA 70 rechargeable battery

- Make sure that the BA 70 rechargeable battery is inserted as follows:

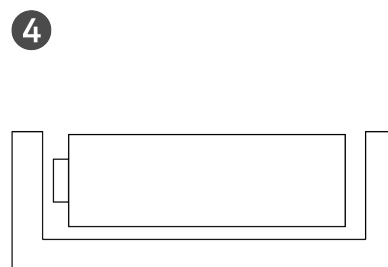
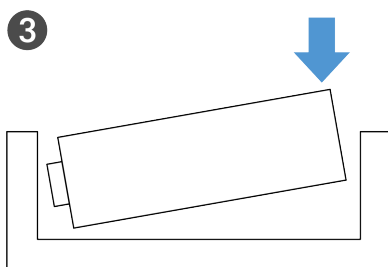
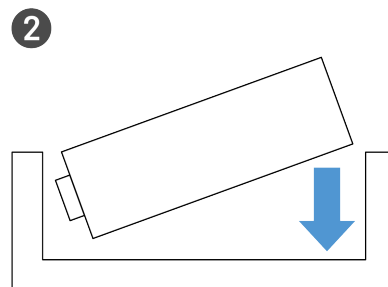
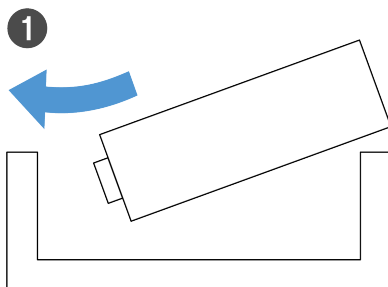



Connecting a microphone to the bodypack transmitter

To connect a microphone to the EW-DX SK bodypack transmitter:

- ▷ Insert the cable's 3.5 mm jack plug into the socket on the bodypack transmitter as shown in the diagram.
- ▷ Screw the plug's coupling ring onto the audio socket thread of the bodypack transmitter.

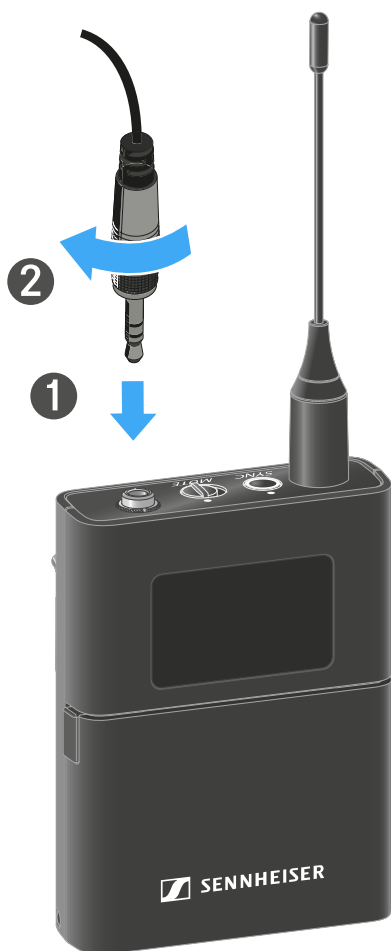

Compatible microphones

The following microphones are compatible with the EW-DX SK bodypack transmitter:



Lavalier microphones:

- **ME 2** | Lavalier microphone with omni-directional pattern (models from 2021 and later with gold-plated plug*)
- **ME 4** | Lavalier microphone with cardioid pattern (models from 2021 and later with gold-plated plug*)
- **MKE Essential Omni** | Lavalier microphone with omni-directional pattern
- **MKE 2 Gold** | Lavalier microphone with omni-directional pattern (models from 2018 and later with blue serial number label)
- **MKE 1** | Lavalier microphone with omni-directional pattern
- **MKE mini** | Lavalier microphone with omni-directional pattern
- **ME 3** | Headset microphone with cardioid pattern (models from 2021 and later with gold-plated plug*)
- **HSP Essential Omni** | Headset microphone with omni-directional pattern
- **HSP 2** | Headset microphone with omni-directional pattern (models from March 2020 and later with code 1090 or higher)
- **SH 2** | Headset microphone with omni-directional pattern (models from 2021 and later with gold-plated plug*)
- **SL Headmic 1** | Headset microphone with omni-directional pattern

*Pre-2021 models with a nickel plug are not recommended. They can pick up noise if they are placed too close to the transmitter.



To connect a microphone to the EW-DX SK 3-PIN bodypack transmitter:

- ▷ Insert the cable's three-pin plug into the socket on the bodypack transmitter as shown in the diagram.
- ▷ Screw the plug's coupling ring onto the audio socket thread of the bodypack transmitter.

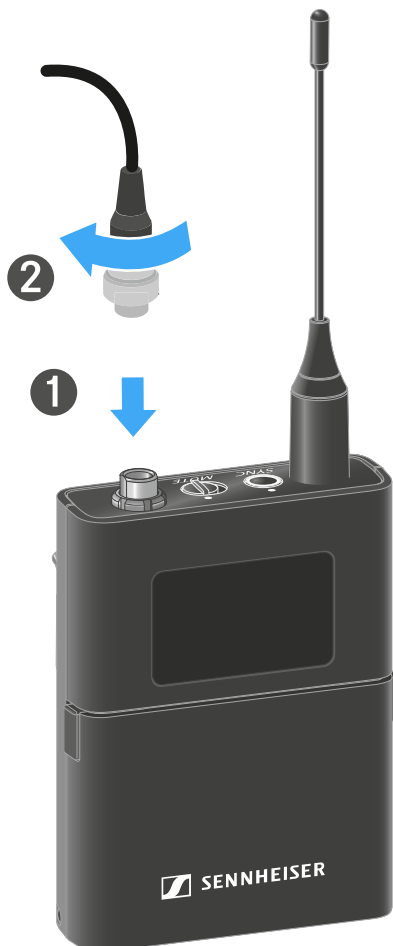

Compatible microphones

The following microphones are compatible with the EW-DX SK 3-PIN bodypack transmitter:



Lavalier microphones:

- **MKE 1-4** | Lavalier microphone with omni-directional pattern
- **MKE 2-4** | Lavalier microphone with omni-directional pattern
- **MKE 40-4** | Lavalier microphone with cardioid pattern
- **MKE Essential Omni Black-3-Pin** | Lavalier microphone with omni-directional pattern
- **MKE Essential Omni Beige-3-Pin** | Lavalier microphone with omni-directional pattern

Headset microphones:

- **HSP Essential Omni Black-3-Pin** | Headset microphone with omni-directional pattern
- **HSP Essential Omni Beige-3-Pin** | Headset microphone with omni-directional pattern
- **HSP 2** | Headset microphone with omni-directional pattern
- **HSP 4** | Headset microphone with cardioid pattern
- **SL Headmic 1-4** | Headset microphone with omni-directional pattern



Connecting an instrument or line source to the bodypack transmitter

To connect a microphone to the **EW-DX SK 3-PIN** bodypack transmitter:

i You can connect instruments or audio sources with a line level to the bodypack transmitter.

To do this, you will need the **CL 1** (6.3 mm jack plug on a lockable 3.5 mm jack plug) or **CL 2** (XLR-3F plug on a lockable 3.5 mm jack plug) Sennheiser cables.

- ▷ Insert the cable's 3.5 mm jack plug into the socket on the bodypack transmitter as shown in the diagram.
- ▷ Screw the plug's coupling ring onto the audio socket thread of the bodypack transmitter.

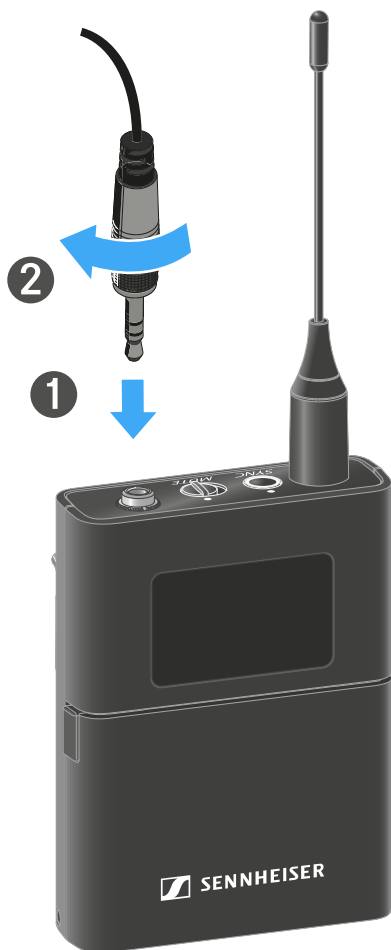



To connect an instrument or line source to bodypack transmitter:

i You can connect instruments or audio sources with a line level to the bodypack transmitter.

To do so, you require the Sennheiser **CI 1-4** cable (6.3 mm (1/4") jack plug to screw-on 3-pin audio connector).

- ▷ Insert the cable's three-pin plug into the socket on the bodypack transmitter as shown in the diagram.
- ▷ Screw the plug's coupling ring onto the audio socket thread of the bodypack transmitter.

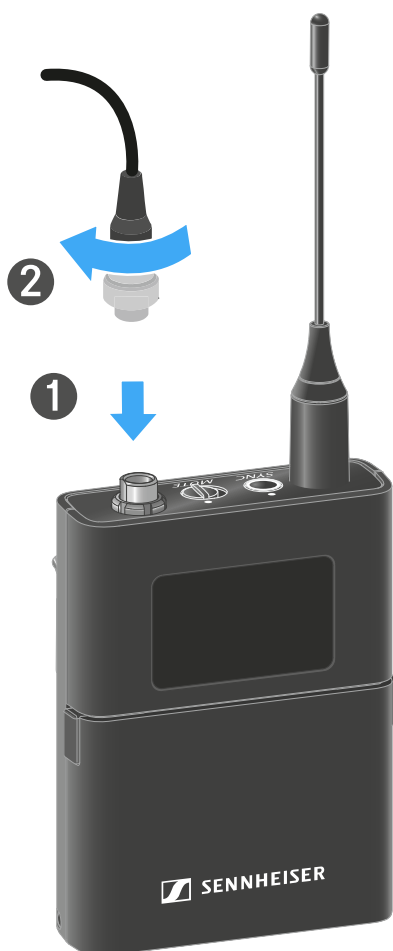



Changing the belt clip

You can change the belt clip on the bodypack transmitter or flip it over depending on how you want to wear it.

To remove the belt clip:

- ▷ Carefully loosen the belt clip with a small screwdriver as shown in the figure.
- ▷ Be very careful not to scratch the housing.

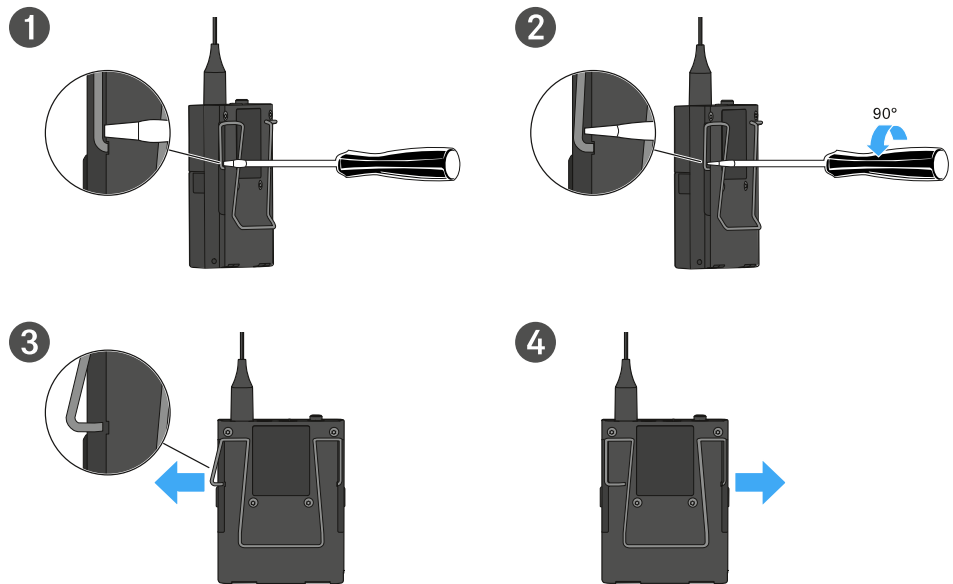

To insert the belt clip:

- ▷ Insert one side of the belt clip first as shown in the figure.
- ▷ Then insert the second side of the belt clip.
- ▷ Gently press the belt clip all the way in on both sides.
- ▷ Always insert one side before the other, not at the same time, as otherwise the belt clip could bend.

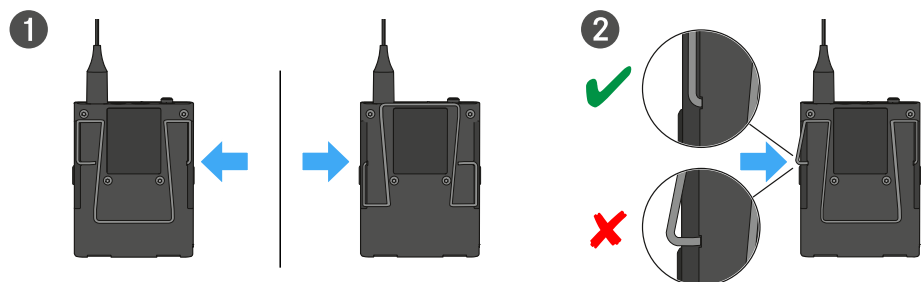



Switching the bodypack transmitter on and off

To switch the bodypack transmitter on:

- ▷ Short-press the **ON/OFF** button.
 - ➔ The **LINK** LED lights up and the transmitter switches on.

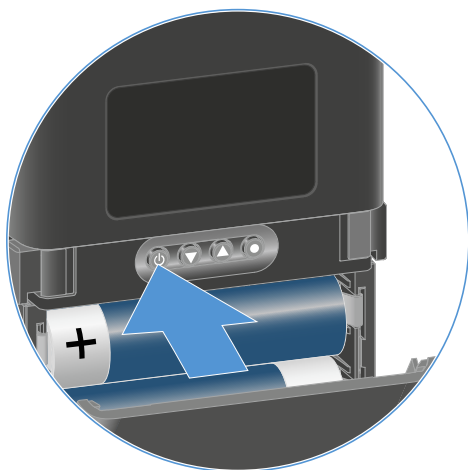

To switch the bodypack transmitter off:

- ▷ Hold down the **ON/OFF** button until the LEDs switch off.

- i** Note that the transmitter's permanent E-Ink display still displays the parameters after it is switched off.

Display when transmitter is switched on:

```
EW-DX 1
510.100
```

Display when transmitter is switched off:

```
EW-DX 1
510.100
off
```





Checking the battery status of the transmitter (Check function)

To check the battery status of the transmitter:

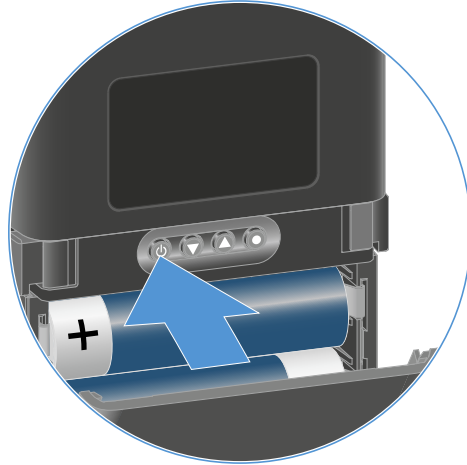
- ▷ Short-press the **ON/OFF** button on the transmitter.



- ➔ The transmitter's **LINK LED** flashes to indicate the current charge level of the battery or the BA 70 rechargeable battery.

LINK LED	
	≤ 100 %
	≤ 60 %
	≤ 20 %

In addition, the battery status is displayed on the transmitter display for approx. 5 seconds.



- i** Pressing the transmitter's **ON/OFF** button will simultaneously trigger the Identify function: [Identifying the paired receiver \(Identify function\)](#).



Identifying the paired receiver (Identify function)

In multi-channel systems, you can use the **Check** function to quickly identify to which receiver the transmitter is paired.

i Both the transmitter and receiver must be switched on.

▷ Short-press the **ON/OFF** button on the transmitter.

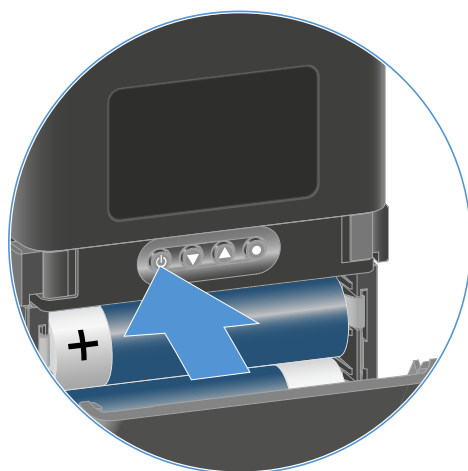

➔ An eye flashes next to the respective receiving channel on the coupled receiver's display.

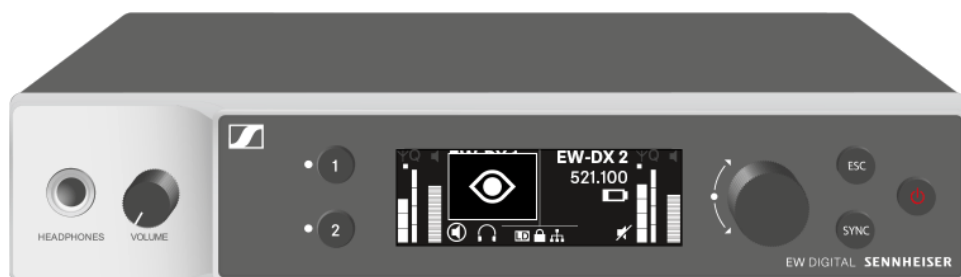

i Pressing the transmitter's ON/OFF button will simultaneously trigger the Check function: [Checking the battery status of the transmitter \(Check function\)](#).



Meaning of the LEDs

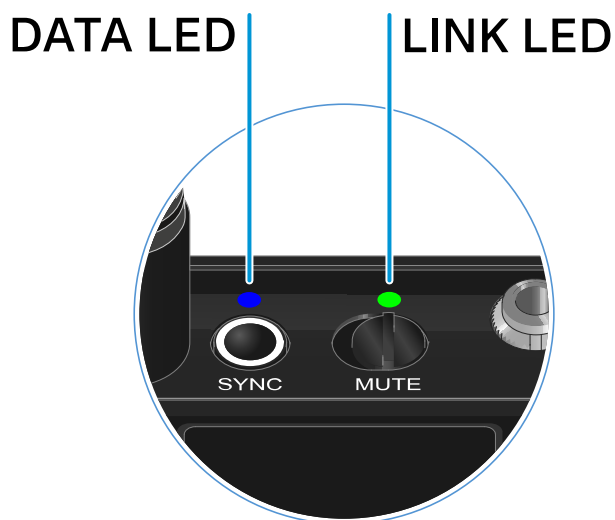

The **LINK** and **DATA** LEDs on the top of the transmitter can indicate the following information.

LINK LED

The **LINK** LED provides information about the status of the radio link between the transmitter and receiver, as well as status information for the paired transmitter.



The LED is green:



- The link between the transmitter and receiver is established.
- The transmission frequency is active.

The LED is yellow:



Or

- The link between the transmitter and receiver is established.
- The audio signal is muted.
- No microphone module is mounted on the SKM-S handheld transmitter.

The LED is flashing yellow:



- The link between the transmitter and receiver is established.
- The audio signal is overdriven (clipping).

The LED is continuously red:



- The (rechargeable) battery in the transmitter is dead.

The LED is flashing red:



- The link between the transmitter and receiver is established.
- The battery/rechargeable battery in the transmitter is low.

The LED is off:



- No link between the transmitter and receiver.
- The transmitter is switched off.



DATA LED

The **DATA** LED provides information about the synchronization of transmitters and receivers.

The LED is flashing blue:



- The transmitter is being synchronized with a receiver.
-

The LED is blue:



- The firmware is being updated.
-

The LED is off:



- There is currently no active data link.
-



Establishing a connection to the receiver

To establish a radio link between the transmitter and the receiver, the devices must be synchronized.

See [Establishing a radio link | Synchronizing the receiver and transmitter](#)

i Conditions and restrictions for using frequencies

There may be special conditions and restrictions for using frequencies in your country.

Before putting the product into operation, find the information for your country at the following address:

[sennheiser.com/sifa](https://www.sennheiser.com/sifa)



Information on the bodypack transmitter's display

You can view the following information on the transmitter display.

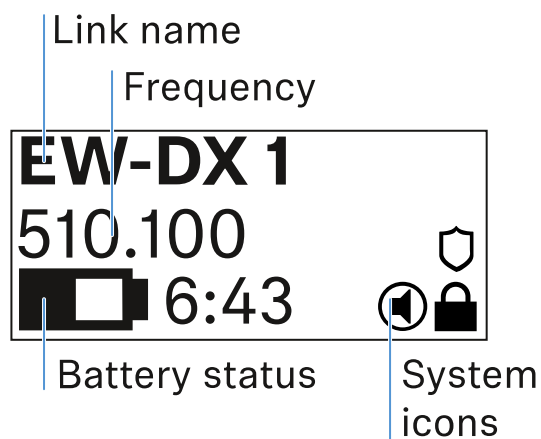

Link name

- You can assign a name to the radio link in the transmitter's menu (see [Name menu item](#)).
- Alternatively, you can assign the name in the receiver's menu and then synchronize it to the transmitter (see [Ch 1 / Ch 2 -> Name menu item](#)).

Frequency

- You can manually set the frequency of the radio link in the transmitter's menu (see [Frequency menu item](#)).
- The frequency of the radio link can also be set manually in the receiver's menu (see [Ch 1 / Ch 2 -> Frequency menu item](#)) or via the **Auto Setup** function (see [Ch 1 / Ch 2 -> Scan / Auto Setup menu item](#)) and then synchronized to the transmitter.



Battery status

- Displays the charging status of the batteries or the BA 70 battery pack.
- When using the BA 70 rechargeable battery, the remaining runtime is also displayed in hours and minutes.
- The battery status is hidden in the display's default state. Short-press the **On/Off** button on the transmitter (Check function, see [Checking the battery status of the transmitter \(Check function\)](#)) to display the battery status for approx. 5 seconds.



System icons



The transmitter's mute switch is deactivated. See [Mute Button menu item](#).



The **Auto Lock** function is activated. See [Auto Lock menu item](#).



AES 256 encryption is enabled. See [System -> Encryption menu item](#).

i Note that the transmitter's permanent E-Ink display still displays the parameters after it is switched off.

Display when transmitter is switched on:

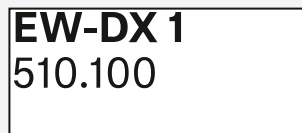

Display when transmitter is switched off:

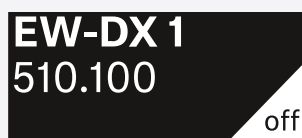



Buttons for navigating the menu

Use the following buttons to navigate through the transmitter's operating menu.

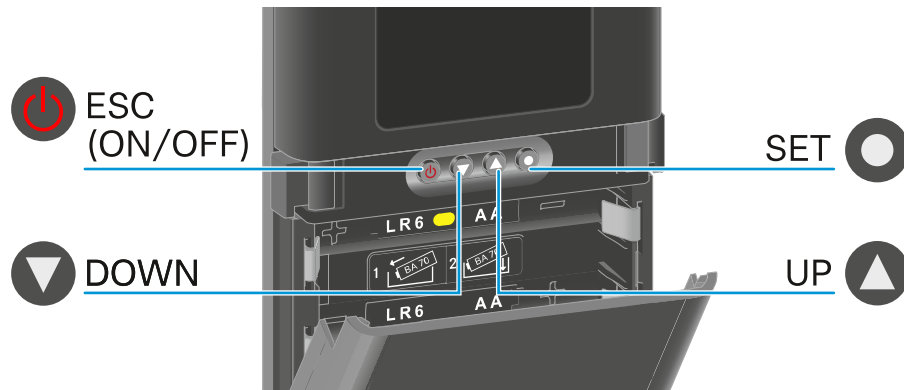

Press the **SET** button

- Jumps from the home screen to the operating menu
- Calls up a menu item
- Saves settings



Press the **UP** or **DOWN** button

- Changes to the previous or next menu item
- Changes the setting of a menu item



Press the **ESC (ON/OFF)** button

- Cancels the entry and returns to the previous display

i [Opening the menu and navigating the menu items](#)



Opening the menu and navigating the menu items

Navigating through the menu and making changes in a menu item

To open the menu:

- ▷ Press the **SET** button.
 - ➡ The operating menu is shown on the transmitter display panel.

To open a menu item:

- ▷ Press the **UP** or **DOWN** buttons to navigate through the individual menu items.
- ▷ Press the **SET** button to open the selected menu item.

To make changes in a menu item:

- ▷ Press the **UP** or **DOWN** buttons to set the displayed value.
- ▷ Press the **SET** button to save the setting.
- ▷ Press the **ESC** button to leave the menu item without saving the setting.

Related information

[Name menu item](#)
[Frequency menu item](#)
[Low Cut menu item](#)
[Trim menu item](#)
[Cable Emulation menu item](#)
[Test Tone menu item](#)
[Mute Button menu item](#)
[Auto Lock menu item](#)
[Brightness menu item](#)
[LED menu item](#)
[This Device menu item](#)

Name menu item

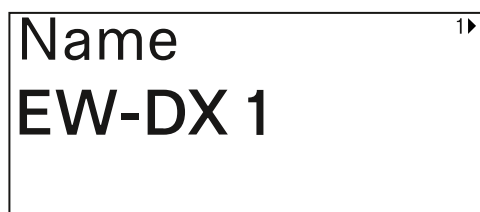



You can enter the name of the link in this menu item.



- ▷ Press the **UP** or **DOWN** buttons to select a character.
- ▷ Press the **SET** button to go to the next position.
- ▷ At the last position, press the **SET** button to save the selected name.

i If you enter a name for the radio link in the **Name** menu item on the receiver and then synchronize the receiving channel with the transmitter, the name entered in the transmitter is overwritten with the name entered in the receiver.



Frequency menu item

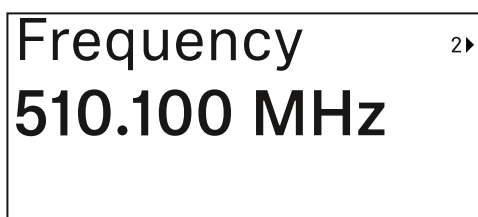

In this menu item, you can set the transmitter's transmission frequency.



- ▷ Press the **UP** or **DOWN** button to set the frequency's MHz range.
- ▷ Press the **SET** button to confirm your selection.

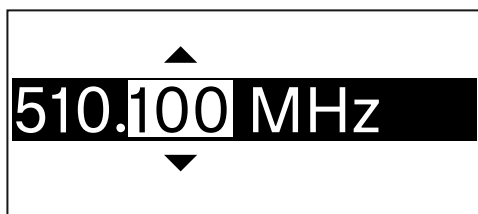

- ▷ Press the **UP** or **DOWN** button to set the frequency's kHz range.
- ▷ Press the **SET** button to save the set frequency.

i If you set a frequency for the channel using the **Frequency** menu item on the receiver or via the **Scan / Auto Setup** function and then synchronize the receiving channel with the transmitter, the frequency entered in the transmitter is overwritten by the frequency set in the receiver.



Low Cut menu item

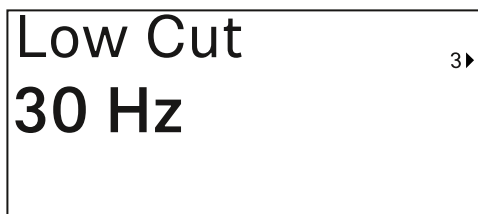

In this menu item, you can adjust the value for the low cut filter.

- Setting range: Off, 30 Hz, 60 Hz, 80 Hz, 100 Hz, 120 Hz

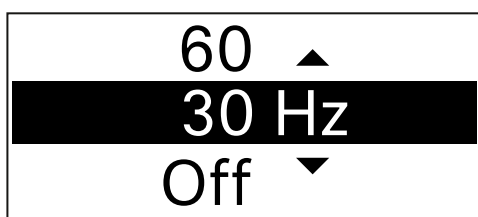

- ▷ Press the **UP** or **DOWN** button to set the desired value.
- ▷ Press the **SET** button to confirm your selection.

i If you set a value for the channel's low cut filter using the **Low Cut** menu item on the receiver and then synchronize the receiving channel with the transmitter, the value entered in the transmitter is overwritten by the value set in the receiver.



Trim menu item

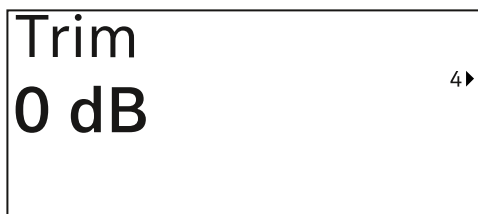

In this menu item, you can adjust the audio level of the transmitter as well as the gain of the wireless link (can be set only on the receiver) to suit input signals of different volumes.

- Setting range: **-12 dB** to **+6 dB** in increments of 1 dB

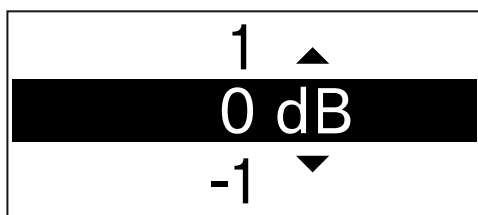

- ▷ Press the **UP** or **DOWN** button to set the desired value.
- ▷ Press the **SET** button to confirm your selection.

i If you set a value for the channel in the **Trim** menu item on the receiver and then synchronize the receiving channel with the transmitter, the value entered in the transmitter is overwritten with the value entered in the receiver.



Cable Emulation menu item

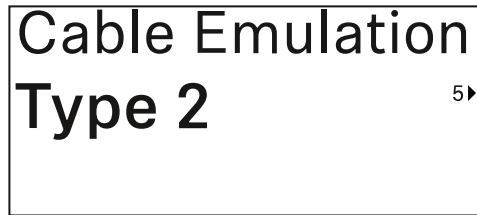

In this menu item, you can emulate instrument cable lengths

- Setting range: Off, Type 1, Type 2, Type 3

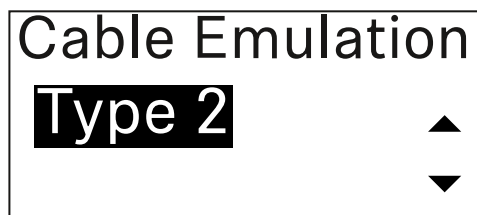

- ▷ Press the **UP** or **DOWN** button to set the desired value.
- ▷ Press the **SET** button to confirm your selection.

i If you set a value for the channel in the **Cable Emul.** menu item on the receiver and then synchronize the receiving channel with the transmitter, the value entered in the transmitter is overwritten with the value entered in the receiver.



Test Tone menu item

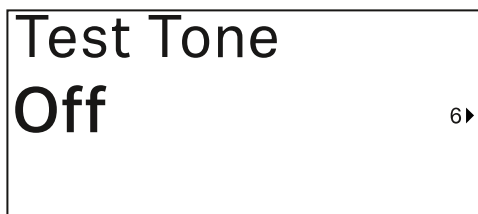

In this menu item, you can activate a test tone that the transmitter transmits instead of the input signal. You can use this feature to level out the system, for example.

- Setting range: **Off, -90 dB to 0 dB** in 6 dB increments



- ▷ Press the **UP** or **DOWN** button to set the desired value.
- ▷ Press the **SET** button to confirm your selection.



Mute Button menu item



In this menu item you can set the function of the transmitter's mute switch.

Setting range:

- **Disabled:** The mute switch has no function.
- **RF Mute:** The RF signal is deactivated when the mute switch is on.
- **AF Mute:** The audio signal is muted when the mute switch is on.



- ▷ Press the **UP** or **DOWN** button to set the desired value.
- ▷ Press the **SET** button to confirm your selection.

i If you set a function for the transmitter's mute switch in the **Mute Mode** menu item on the receiver and then synchronize the receiving channel with the transmitter, the value entered in the transmitter is overwritten with the value entered in the receiver.



Auto Lock menu item



In this menu item, you can activate or deactivate the automatic lock-off for the transmitter.

The lock-off prevents the transmitter from being unintentionally switched off and also prevents any changes to the transmitter's menu.

- i** The lock-off prevents the transmitter from being unintentionally switched off and also prevents any changes to the transmitter's menu. See [Lock-off function](#).



- ▷ Press the **UP** or **DOWN** button to set the desired value.
- ▷ Press the **SET** button to confirm your selection.

- i** If you set a value for the transmitter's automatic lock-off in the **Auto Lock** menu item on the receiver and then synchronize the receiving channel with the transmitter, the value entered in the transmitter is overwritten with the value entered in the receiver.



Brightness menu item



In this menu item, you can adjust the brightness of the transmitter's display.

You can turn off the backlight completely or set it to one of five brightness levels.



- ▷ Press the **UP** or **DOWN** button to set the desired value.
- ▷ Press the **SET** button to confirm your selection.



LED menu item



This menu item allows you to set the behavior of the transmitter's LINK LED.

Setting range:

- **ON:** The LINK LED remains continuously lit.
- **OFF:** The LINK LED switches off while the lock-off function is active.

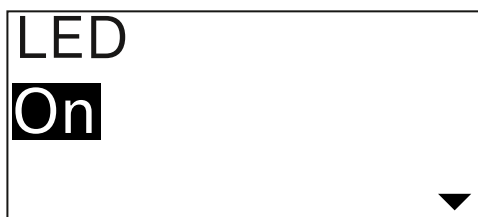

- ▷ Press the **UP** or **DOWN** button to set the desired value.
- ▷ Press the **SET** button to confirm your selection.

i If you set a function for the transmitter's LINK LED in the **LED** menu item on the receiver and then synchronize the receiving channel with the transmitter, the value entered in the transmitter is overwritten with the value entered in the receiver.



This Device menu item



In this menu item you can view information about the transmitter's software and hardware and reset the transmitter to the factory settings.

Show software

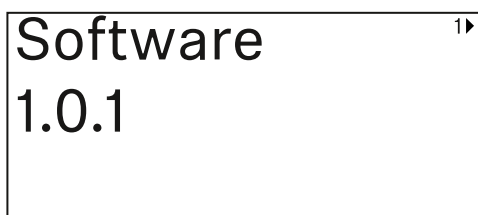

Show hardware

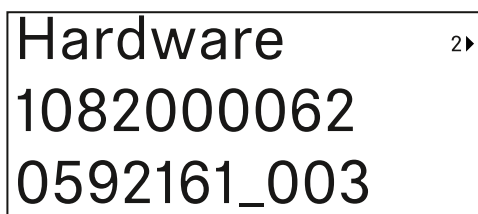

Reset to factory settings

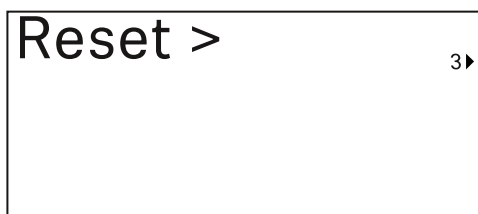



- ▷ Press the **SET** button to open the Reset menu item.



- ▷ Press the **UP** or **DOWN** button to set the desired value.
- ▷ Press the **SET** button to confirm your selection.



Lock-off function

You can enable or disable the automatic lock-off function in the **Auto Lock** menu item (see [Auto Lock menu item](#)).

The lock-off function prevents the transmitter from being unintentionally switched off and also prevents any unintentional changes to the transmitter's configuration.

If you have enabled the **Auto Lock** function, you will have to temporarily deactivate the lock-off function to operate the transmitter.

To temporarily deactivate the lock-off function:

- ▷ Press the **SET** button.
 - ➔ Locked appears in the display panel.
- ▷ Press the **UP** or **DOWN** button.
 - ➔ Unlock? appears in the display panel.
- ▷ Press the **SET** button.
 - ➔ Lock-off function is now temporarily deactivated.

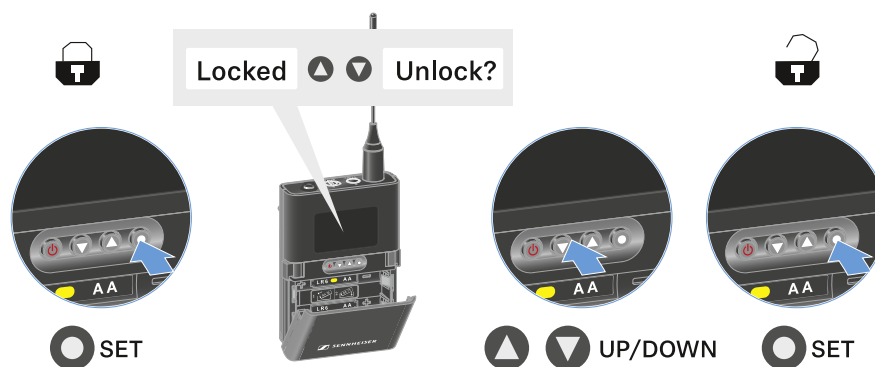

- ✓ The lock-off function remains deactivated while you are actively working in the operating menu.

i After 10 seconds of inactivity, it automatically activates again.



Configuring mute mode and muting the bodypack transmitter

You can mute the handheld transmitter by using the mute switch to turn off either the audio signal (**AF Mute**) or the RF signal (**RF Mute**).

To do this, you must configure the function of the mute switch in the **Mute Mode** menu item.

- On the receiver: [Ch 1 / Ch 2 -> Mute Mode menu item](#)
- On the transmitter: [Mute Button menu item](#)

AF Mute

▷ Slide the mute switch to the desired position to mute or activate the audio signal.



RF Mute

▷ Slide the mute switch to the desired position to activate or deactivate the RF signal.

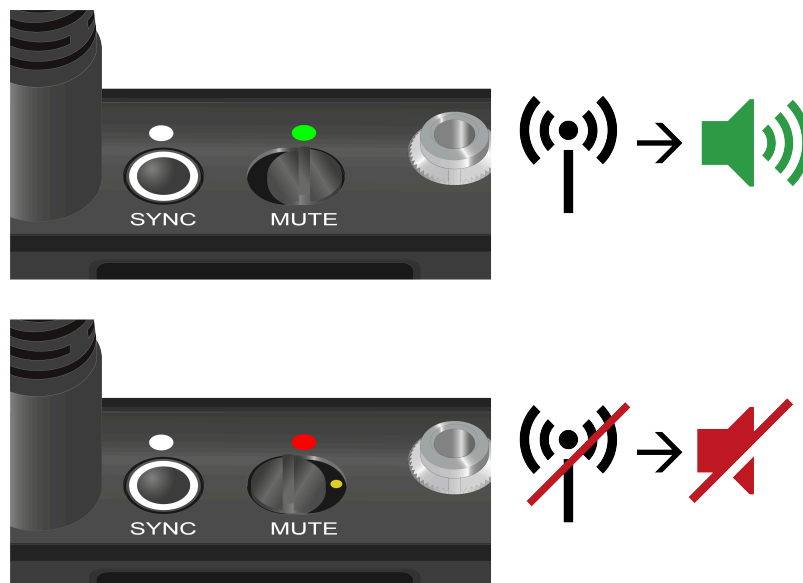



Updating the firmware of the transmitter

The transmitter firmware is updated via the receiver.

- ▷ Update the transmitter firmware using the **TX Update** menu item in the receiver's System menu. See [Ch 1 / Ch 2 -> TX Software menu item](#).



Table stand EW-DX TS 3-pin | EW-DX TS 5-pin

- [Product overview](#)
- [Inserting and removing the BA 40 rechargeable battery](#)
- [Charging the table stand](#)
- [Meaning of the LEDs](#)
- [Connecting a gooseneck microphone](#)
- [Switching the table stand on/off](#)
- [Establishing a connection to the receiver](#)
- [Muting the table stand](#)

Product overview

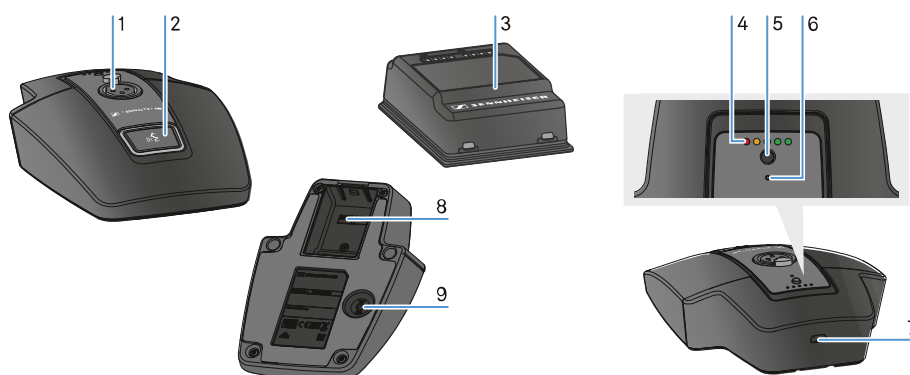

1 XLR socket for connecting a gooseneck microphone

- See [Connecting a gooseneck microphone](#)

2 **MUTE** button with LED

- See [Muting the table stand](#)

3 BA 40 rechargeable battery

- See [Inserting and removing the BA 40 rechargeable battery](#)



4 Charge level LEDs

- See [Meaning of the LEDs](#)

5 ON/OFF button with charge level display

- See [Switching the table stand on/off](#)

6 Bluetooth LED

- See [Meaning of the LEDs](#)

7 USB-C socket

8 Battery compartment for BA 40 rechargeable battery

- See [Inserting and removing the BA 40 rechargeable battery](#)

9 SYNC button

- See [Establishing a connection to the receiver](#)



Inserting and removing the BA 40 rechargeable battery

The included BA 40 rechargeable battery is used to power the table stand. The battery must be charged before first use, either with the optional CHG 2W charging base or in the table stand with a USB cable.

To remove the battery:

- ▷ Pull the unlock button away from the battery and pull the battery out of the compartment.

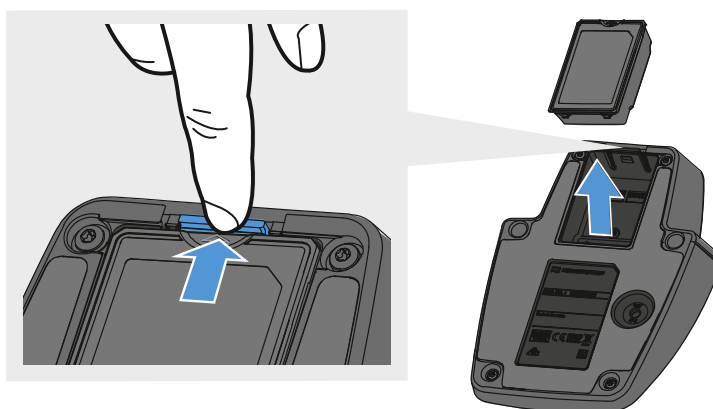

To insert the battery:

- ▷ Slide the battery into the compartment with the correct orientation until the unlock button locks into place.
 - ➔ The charge level LEDs light up briefly and indicate the charge level.

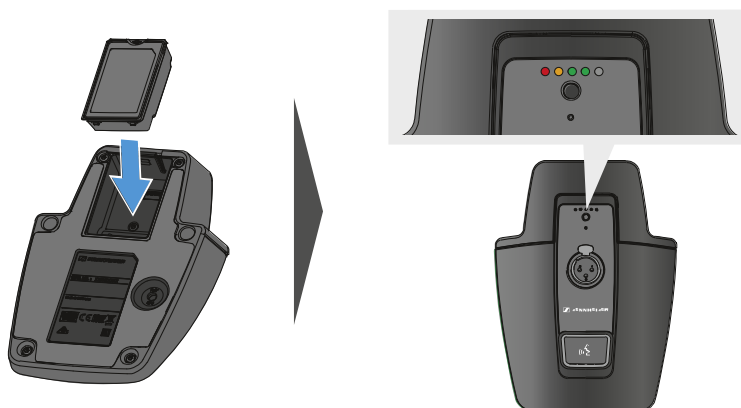



Charging the table stand

To charge the table stand via USB:

- ▷ Connect the USB cable's USB-C plug to the USB-C socket of the table stand.
- ▷ Plug the other end of the USB cable into a USB power supply unit.

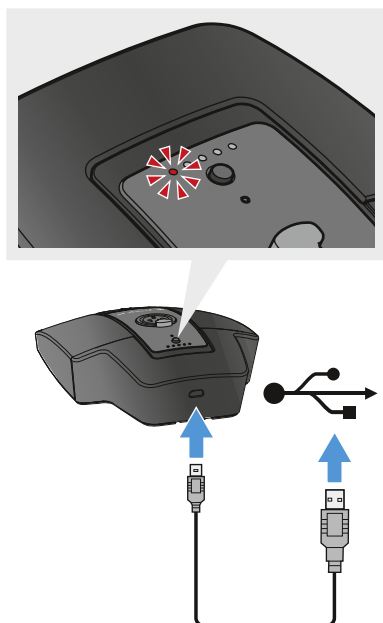

➔ The charge level LEDs indicate the charge level.

- i** Time until fully charged:
- EW-DX TS 3-pin: 7 hours when on, 5.5 hours when off
 - EW-DX TS 5-pin: 7.5 hours when on, 5.5 hours when off



To charge the table stand using the wireless CHG 2W charging base:

- ▷ Place the table stand on marked area of the CHG 2W charging base.

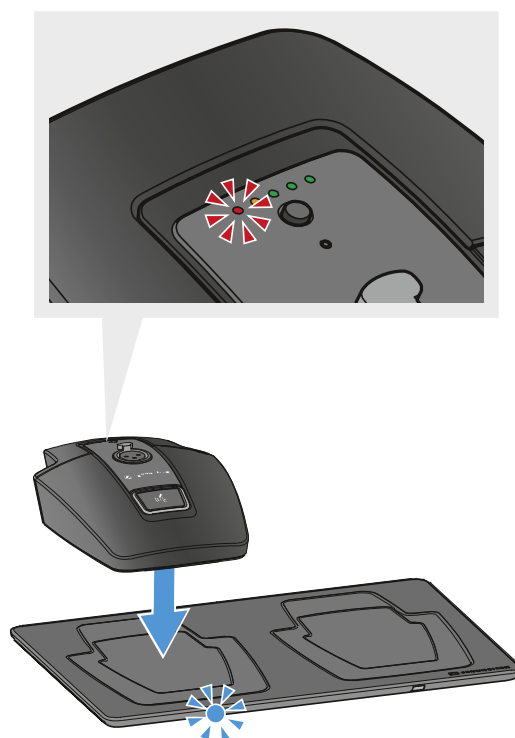

- ➔ When the table stand is positioned correctly on the charging surface, the charge level LEDs indicate the charge level.

The LEDs on the CHG 2W charging base flash blue during charging.

- i** Time until fully charged:
- EW-DX TS 3-pin: 5 hours when on, 4.5 hours when off
 - EW-DX TS 5-pin: 5.5 hours when on, 4.5 hours when off

To charge the table stand with a wireless Qi charging base from a third-party manufacturer:

- i** You can charge the table stand with any charging base that uses the wireless Qi charging standard. Place the table stand on the third-party Qi charging base. The charge level LED lights up once the table stand is correctly positioned.

- ▷ You can find more information about third-party Qi charging bases in the documentation from the respective manufacturers.



Meaning of the LEDs

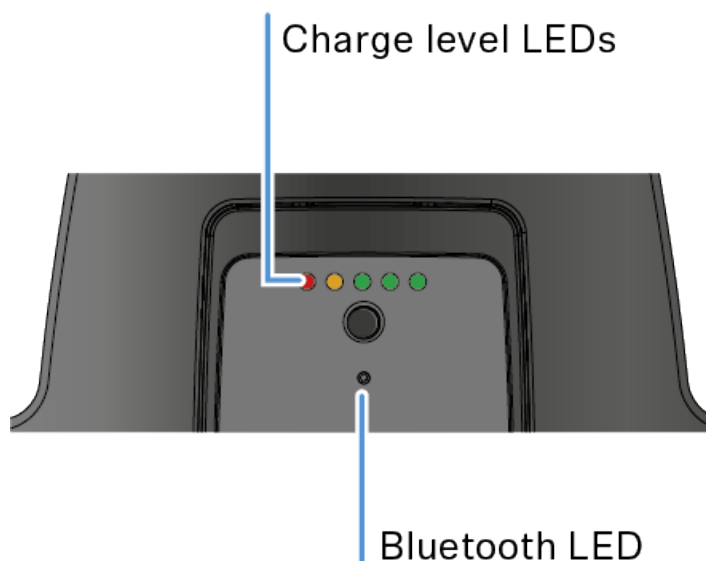

The **charge level** and **Bluetooth** LEDs on the top of the transmitter can indicate the following information.

Charge level LEDs

The charge level is indicated on the table stand via the charge level LEDs. At 100% charge, the EW-DX TS 3-pin and EW-DX TS 5-pin have an approximate operating time of 11 and 10 hours respectively.

The operating time with the BA 40 rechargeable battery is as follows:

	100 %
	80 %
	60 %
	40 %
	20 %



Low battery

Bluetooth LED

The Bluetooth LED provides information about the synchronization of transmitters and receivers.

The LED is flashing blue:

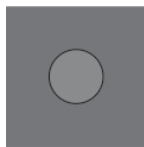

- The transmitter is being synchronized with a receiver.

The LED is blue:

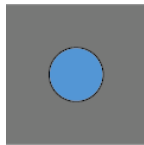

- The firmware is being updated.

The LED is off:

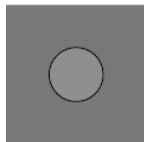

- There is currently no active data link.
-



Connecting a gooseneck microphone

The following gooseneck microphone is compatible with the EW-DX TS 5-pin table stand:

- **MEG 14-40-L-II B** | Gooseneck microphone, 40 cm

The following gooseneck microphones are compatible with the EW-DX TS 3-pin table stand:

- **MEG 14-40 B** | Gooseneck microphone, 40 cm
- **MZH 3015** | Gooseneck, 15 cm
- **MZH 3040** | Gooseneck, 40 cm
- **MZH 3042** | Gooseneck, 40 cm
- **ME 34** | Condenser microphone head
- **ME 35** | Condenser microphone head
- **ME 36** | Condenser microphone head

- ▷ Plug the gooseneck microphone into the XLR socket until it locks into place.

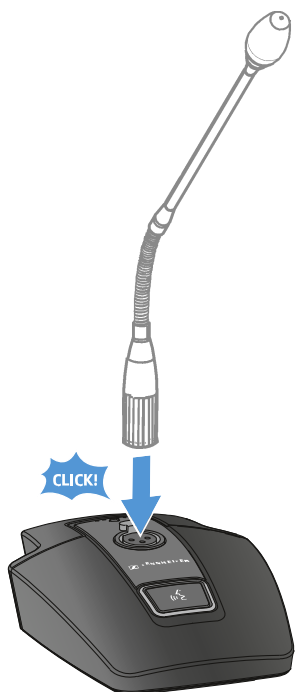



Switching the table stand on/off

To switch the table stand on:

- ▷ Briefly press the **ON/OFF** button.



- ➔ The **MUTE** button lights up green when a gooseneck microphone is connected.

To switch the table stand off:

- ▷ Press and hold the **ON/OFF** button.
- ➔ The **MUTE** button LED goes out.



Establishing a connection to the receiver

To establish a radio link between the transmitter and the receiver, the devices must be synchronized.

See [Establishing a radio link | Synchronizing the receiver and transmitter](#)

i Conditions and restrictions for using frequencies

There may be special conditions and restrictions for using frequencies in your country.

Before putting the product into operation, find the information for your country at the following address:

sennheiser.com/sifa



Muting the table stand

The **MUTE** button can have different functions:

- **Disabled:** The **MUTE** button has no function.
- **AF Mute:** The audio signal is muted when the **MUTE** button is pressed. Pressing the button again activates the audio signal.
- **PTT (Push to talk):** Press and hold the **MUTE** button to activate the audio signal.
- **PTM (Push to mute):** Press and hold the **MUTE** button to mute the audio signal.

The function of the **MUTE** button can be configured in the Mute Mode menu item of the receiver (see [Ch 1 / Ch 2 -> Mute Mode menu item](#)).

To activate muting:

- ▷ Briefly press the **MUTE** button while the table stand is switched on and a gooseneck microphone is connected.

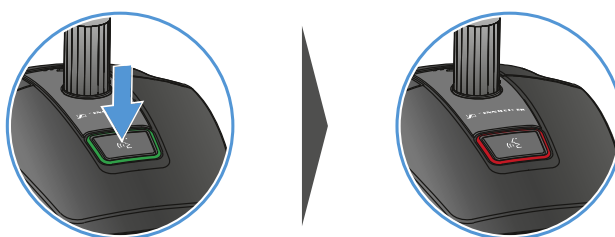

- ➔ The button lights up red.

To cancel the muting:

- ▷ Briefly press the **MUTE** button again.
 - ➔ The button lights up green. The audio signal is activated.



EW-DP EK portable receiver

- Product overview
- Power supply
- Outputting audio signals
- Mounting the receiver / mounting options
- Switching the receiver on and off
- Meaning of the LEDs
- Displays on the receiver's display panel
- Buttons for navigating the menu
- Opening the menu and navigating the menu items
- GAIN menu item
- OUTPUT LEVEL menu item
- HEADPHONE menu item
- MUTE SWITCH menu item
- AUTO SCAN menu item
- CHANNEL menu item
- FREQUENCY menu item
- BRIGHTNESS menu item
- RESET menu item



Product overview

Front

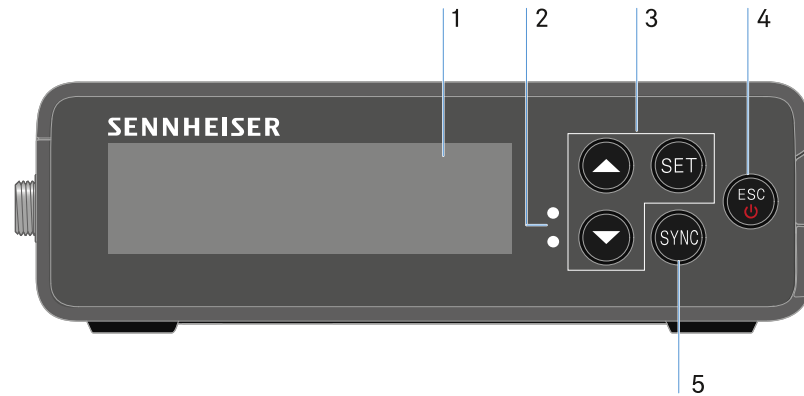

1 Display for status information and operating menu

- See [Meaning of the LEDs](#)

2 **LINK** and **DATA** LEDs to indicate connection status and Bluetooth status

- See [Meaning of the LEDs](#)

3 **UP/DOWN/SET** menu buttons for navigating the operating menu

- See [Buttons for navigating the menu](#)

4 **ESC/ON/OFF** button for canceling an action in the menu or switching the device on and off

- See [Buttons for navigating the menu](#)
- See [Buttons for navigating the menu](#)

5 **SYNC** button for synchronizing the transmitter and receiver

- See [Establishing a radio link | Synchronizing the receiver and transmitter](#)



page

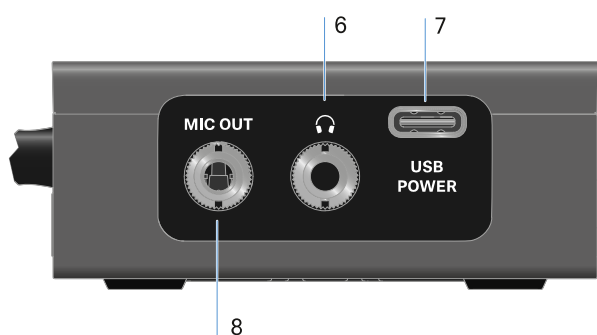

6 3.5 mm jack socket for headphones

- See [Outputting audio signals](#)

7 USB-C connection socket for power supply

- See [Power supply](#)

8 3.5 mm jack socket for connecting cable

- See [Outputting audio signals](#)



Power supply

The EW-DP EK can be powered in two different ways:

Power supply via USB-C from a camera or power bank

- ▶ Connect the receiver to a camera or other power supply using a USB-C cable.

USB-C Power



- i** Power supply via USB-C cable: 5 V/min. 1 A (for max. charging speed of the inserted BA 70)



Power supply via (rechargeable) batteries

- ▷ Open the EW-DP EK unit's battery compartment by pressing in the two release buttons on the sides.

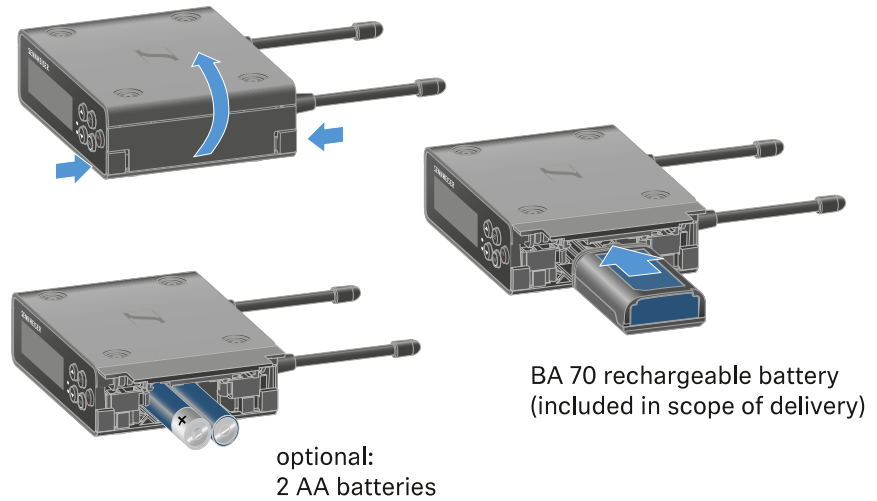

- ▷ Insert either a BA 70 rechargeable battery or 2 AA batteries.
- ▷ Close the battery compartment.

i Primary batteries and USB can be used in parallel without restrictions, as this is controlled by the EK unit.

i The EW-DP EK supports the USB Power Delivery Protocol for smart USB-C power supply units (USB-C PD).



Outputting audio signals

The EW-DP EK has an unbalanced 3.5 mm audio output and an unbalanced 3.5 mm headphone output.

CAUTION



Hearing damage due to high volumes

The product is capable of producing high sound pressure levels. Higher volumes or longer durations can damage your hearing.

- ▷ Set the volume to a medium level.
- ▷ Reduce the volume level before changing a transmitter or a frequency.

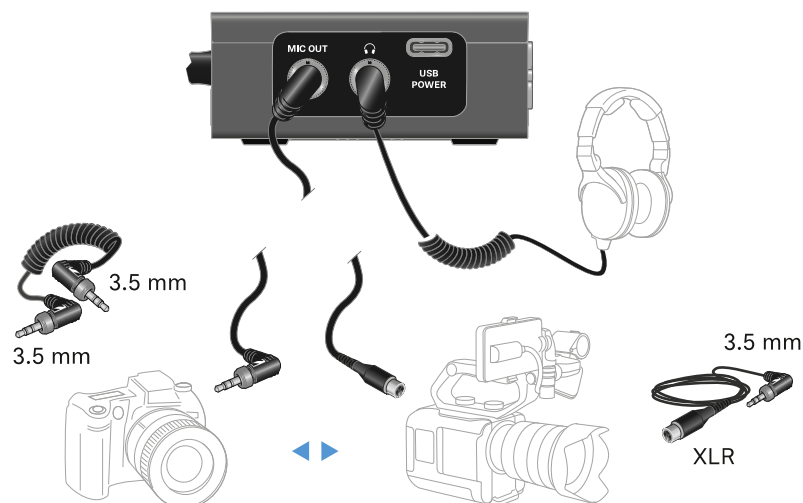

To connect a 3.5 mm jack cable:

- ▷ Plug the jack cable into the MIC OUT socket on the EW-DP EK.



Mounting the receiver / mounting options

EW-DP EK mounting accessories

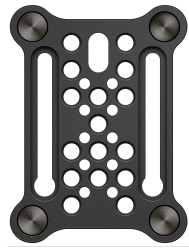

Mounting plate



Hot shoe adapter



Clip



Hex key



Screws

Related information

[Combining the mounting plate and hot shoe adapter](#)

[Mounting plate and clip](#)

[Mounting/stacking receivers on the mounting plate](#)

[Mounting with or without the mounting plate in a rotated position](#)

[Example for mounting on a DSLR or video camera](#)

[Example for mounting on camera cages](#)

[Example for attaching to pockets and belts](#)

[Example for mounting on tripods](#)



Combining the mounting plate and hot shoe adapter

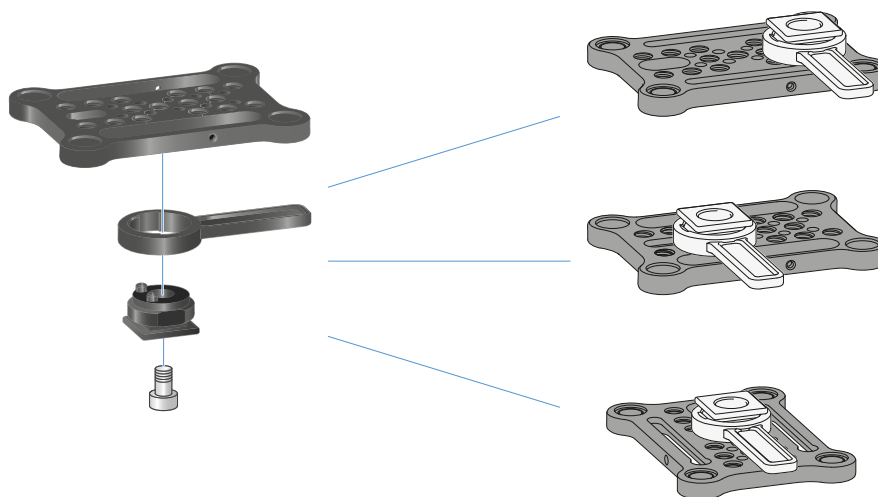

The hot shoe adapter can be fitted to the mounting plate in different positions according to the mounting situation.

To mount the hot shoe adapter on the mounting plate:

- ▷ Pre-assemble the hot shoe adapter by connecting the adapter and lever using the supplied screw.
- ▷ Then screw the hot shoe adapter to the mounting plate at the desired location.



Mounting plate and clip

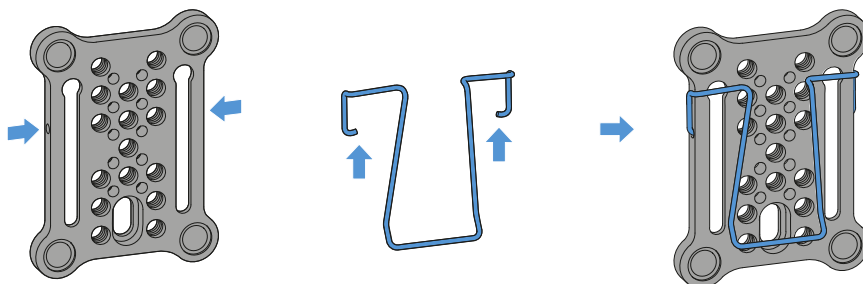

As an alternative to the hot shoe adapter, a metal clip can be attached to the side of the mounting plate.

To mount the clip on the mounting plate:

- ▷ Insert the clip into the side of the mounting plate as shown.
 - ➔ This enables you to attach the receiver to belts or pockets using the mounting plate.



Mounting/stacking receivers on the mounting plate

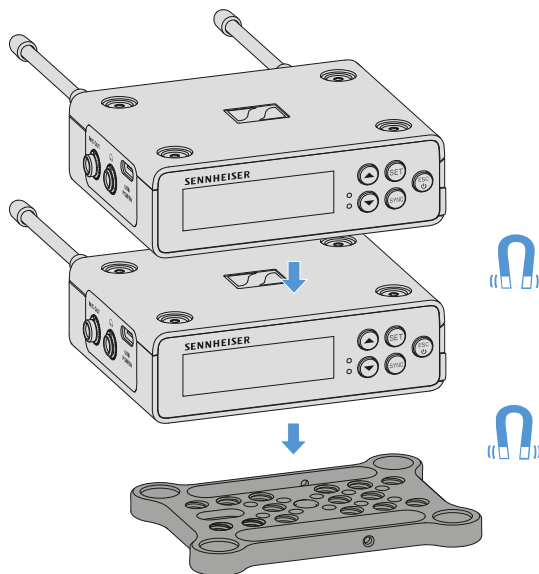

The receiver has magnets on the bottom, which means you can simply place it on the mounting plate without the need for an additional screw connection. This allows you to stack two receivers on top of one another.

To mount the receiver on the mounting plate:

- ▷ Insert the receiver's four magnetic feet into the recesses on the mounting plate.

i Two stacked receivers can be connected to one another using a Y-cable. See [“Cables for EW-DP EK”](#)



Mounting with or without the mounting plate in a rotated position

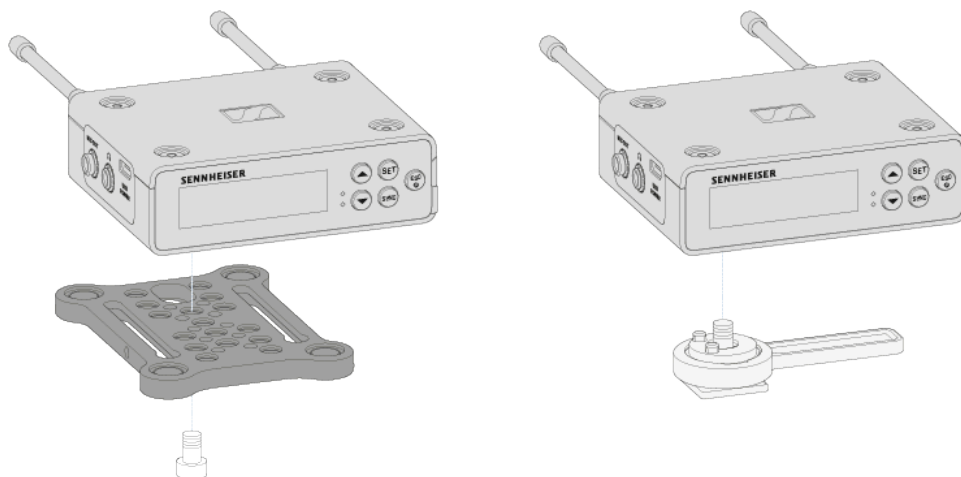

To mount the receiver with the mounting plate rotated by 90°:

- ▷ Turn the mounting plate by 90° and screw it to the bottom of the receiver in the desired position.
 - ➔ This mounting variant is particularly suitable for attaching with a clip.

To mount the receiver without a mounting plate:

- ▷ Screw the hot shoe adapter directly to the bottom of the receiver.
 - ➔ It can now be attached to a camera's hot shoe.



Example for mounting on a DSLR or video camera

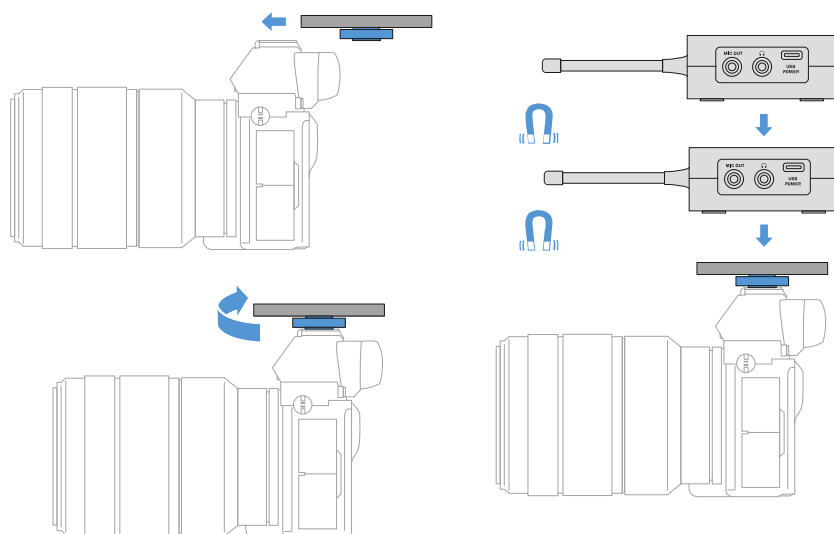

To mount the mounting plate with hot shoe adapter on a DSLR or video camera:

- ▷ Slide the adapter into the camera's hot shoe.
- ▷ Rotate the lever on the hot shoe adapter until the adapter is tightly attached.
 - ➔ Now you can attach one or two receivers to the mounting plate.



Example for mounting on camera cages

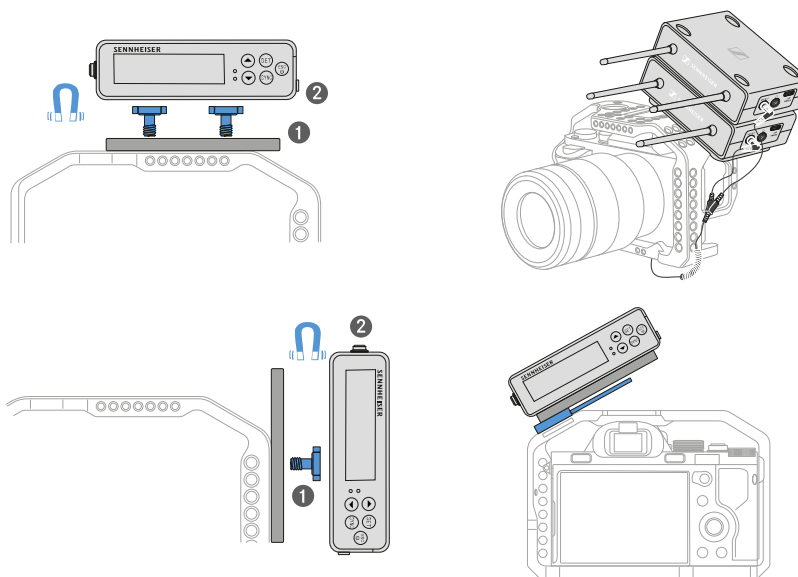

To attach the mounting plate to a camera cage:

- ▷ Screw the mounting plate to the camera cage using one or two screws, depending on the mounting situation and position.
- ▷ Attach the receiver to the mounting plate.



Example for attaching to pockets and belts

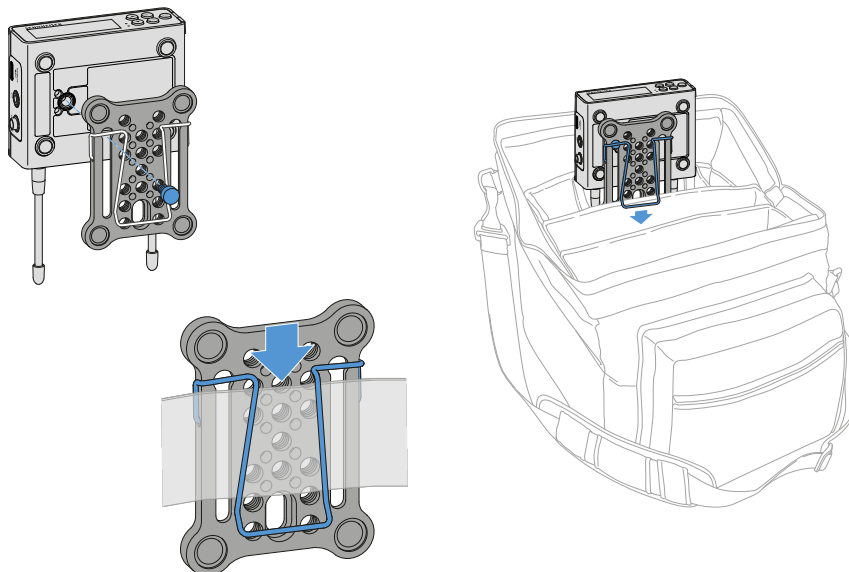

To fasten the receiver with mounting plate to pockets or belts:

- ▷ Attach the clip to the mounting plate.
- ▷ Attach the mounting plate to the receiver by inserting a screw through the slot.
 - ➔ You can now clip the receiver to belts or pockets.



Example for mounting on tripods

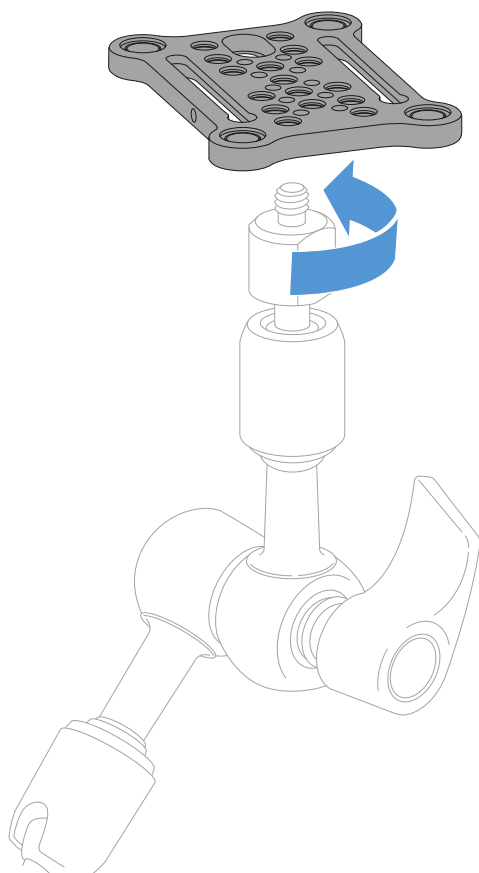

To fasten the mounting plate to a tripod:

- ▷ Screw the mounting plate onto the tripod thread at the desired position.
 - ➔ Now you can attach one or two receivers to the mounting plate.



Switching the receiver on and off

To switch the receiver on:

- ▷ Short-press the **ON/OFF** button.
 - ➔ The receiver switches on.

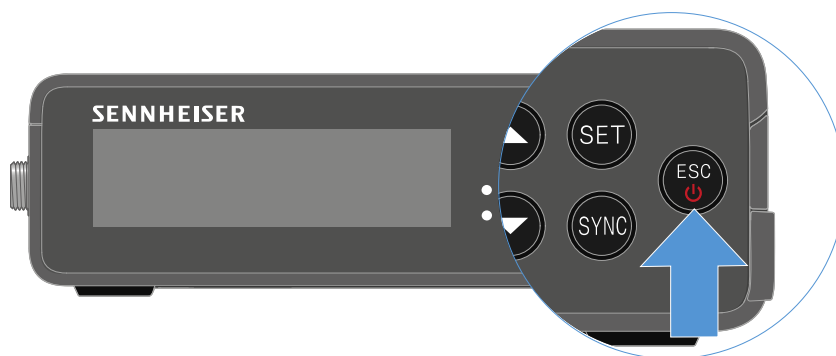

To switch the receiver off:

- ▷ Press the **ON/OFF** button.
 - ➔ The receiver switches off.



Meaning of the LEDs

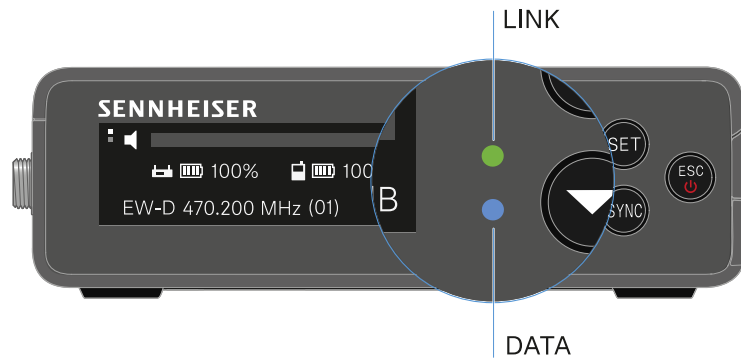

The **LINK** and **DATA** LEDs on the front of the receiver can indicate the following information.

LINK LED

The **LINK** LED provides information about the status of the radio link between the transmitter and receiver, as well as status information for the paired transmitter.

The LED is green:



- The link between the transmitter and receiver is established.
- The audio signal is active.

The LED is yellow:



- The link between the transmitter and receiver is established.
- The audio signal is muted.



or

- No microphone module is mounted on the SKM-S handheld transmitter.

The LED is flashing yellow:



- The link between the transmitter and receiver is established.
- The audio signal is overdriven (clipping).

The LED is continuously red:



- No link between the transmitter and receiver.

The LED is flashing red:



- The battery/rechargeable battery in the paired transmitter is low.

DATA LED

The **DATA** LED provides information on the receiver's **Bluetooth Low Energy** link to the **Smart Assist** app and on the synchronization of transmitters and receivers.

The LED is flashing blue:



- The **Bluetooth Low Energy** link is being established between the receiver and a smartphone or tablet with the **Smart Assist** app.

or

- The receiver is being synchronized with a transmitter.

The LED is blue:



- The firmware is being updated.

The LED is off:



- Normal operation
- There is currently no active data link.



Displays on the receiver's display panel

Status information such as frequency, reception quality, battery status and audio level is shown on the display.

The display also shows the operating menu, which you can use to configure all of the settings (see [Buttons for navigating the menu](#)).

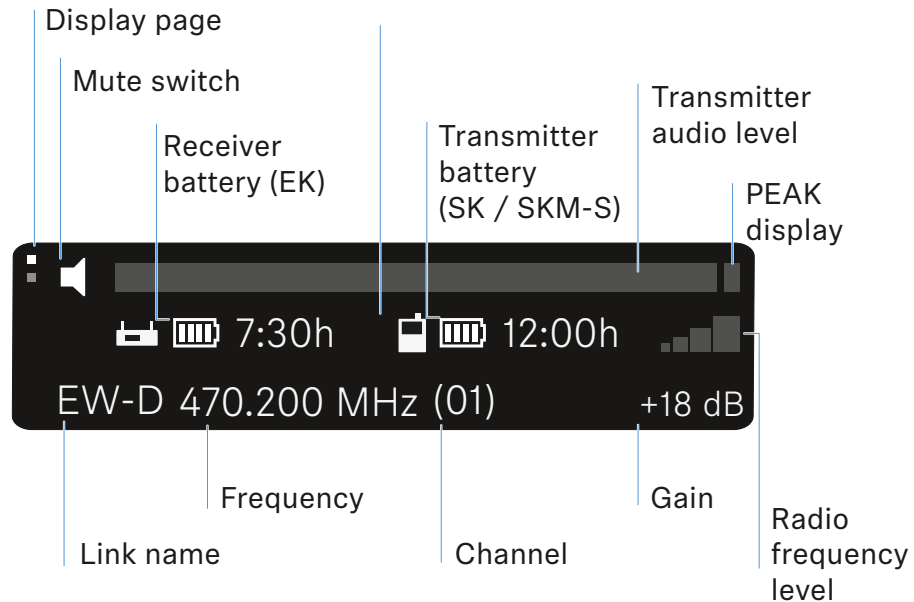

Further information

Display page:

- [Main view and advanced view](#)

Mute / mute switch:

- [MUTE SWITCH menu item](#) | [Muting the handheld transmitter](#) | [Muting the bodypack transmitter](#)

Link name:

- Can be changed in the Smart Assist app.
- Connecting to the app:
- [Smart Assist app](#)

Receiver battery:

- [Power supply](#)



Transmitter battery

- SKM-S: [Inserting and removing the batteries/rechargeable batteries](#) | SK: [Inserting and removing the batteries/rechargeable batteries](#)

Frequency/channel:

- [CHANNEL menu item](#)

Gain/transmitter audio level/PEAK indicator

- [AF OUT menu item](#)

Signal level:

- [GAIN menu item](#)

Main view and advanced view

i After the device switches on, the display shows the main view.



▷ Press the **UP** button to access the advanced view.

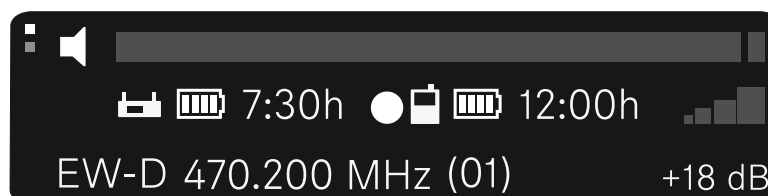



Buttons for navigating the menu

Use the following buttons to navigate through the receiver's operating menu.



Press the **SET** button

- Open the menu
- Save settings in a menu item

Press the **UP** or **DOWN** button

- Changes to the previous or next menu item
- Changes the setting of a menu item

Press the **ESC** button

- Cancel input

i [Opening the menu and navigating the menu items](#)



Opening the menu and navigating the menu items

To open the main menu:

- ▷ Press the **SET** button.
- ➔ The first menu item **GAIN** flashes.

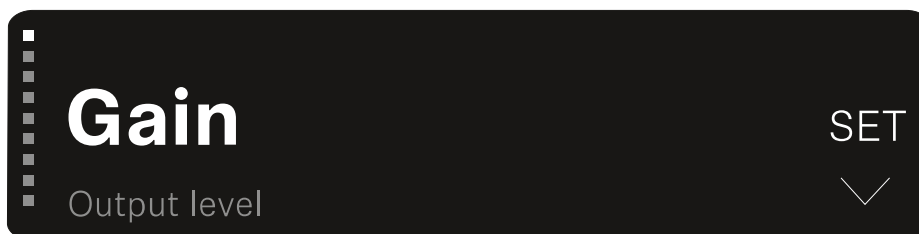

To navigate the menu items:

- ▷ Press the **UP** and **DOWN** buttons.
- ➔ The currently active menu item appears in the display.

To open a menu item:

- ▷ Navigate to the desired menu item until it flashes.
- ▷ Press the **SET** button to open the selected menu item.

Related information

- [GAIN menu item](#)
- [OUTPUT LEVEL menu item](#)
- [HEADPHONE menu item](#)
- [MUTE SWITCH menu item](#)
- [AUTO SCAN menu item](#)
- [CHANNEL menu item](#)
- [FREQUENCY menu item](#)
- [BRIGHTNESS menu item](#)
- [RESET menu item](#)

GAIN menu item

Under the **GAIN** menu item, you can set the level of the audio signal coming from the paired transmitter.



- ▷ Open the **GAIN** menu item.
 - ➔ The display looks as follows.

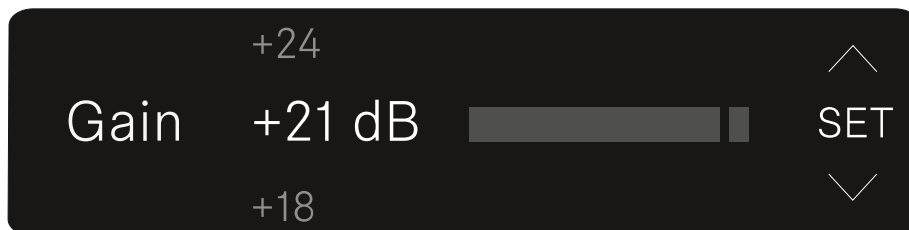

- ▷ Press the **UP** or **DOWN** button to adjust the value.
- ▷ Press the **SET** button to save the set value.
 - ➔ You will then be returned to the main view or advanced view.



OUTPUT LEVEL menu item

Under the **OUTPUT LEVEL** menu item, you can set the level of the audio signal coming from the receiver's audio outputs. This audio signal can be output to a camera input or a mixing console, for example.

▷ Open the **OUTPUT LEVEL** menu item.

➔ The display looks as follows.

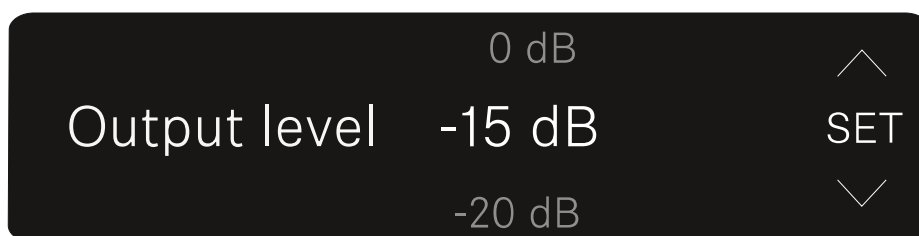

▷ Press the **UP** or **DOWN** button to adjust the value.

▷ Press the **SET** button to save the set value.

➔ You will then be returned to the main view or advanced view.



HEADPHONE menu item

Under the **HEADPHONE** menu item, you can set the volume of the audio signal coming from the receiver's headphone output.

CAUTION



Hearing damage due to high volumes

The product is capable of producing high sound pressure levels. Higher volumes or longer durations can damage your hearing.

- ▷ Set the volume to a medium level.
- ▷ Reduce the volume level before changing a transmitter or a frequency.

- ▷ Open the **HEADPHONE** menu item.
 - ➔ The display looks as follows.

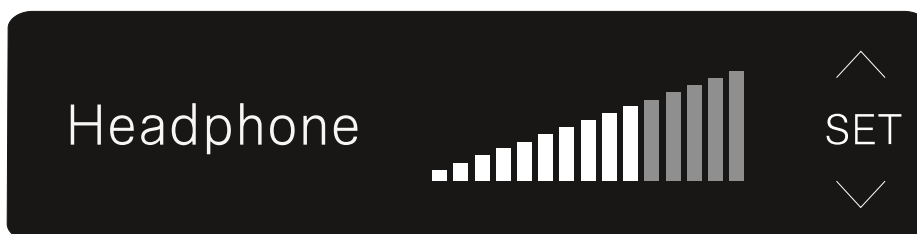

- ▷ Press the **UP** or **DOWN** button to adjust the value.
- ▷ Press the **SET** button to save the set value.
 - ➔ You will then be returned to the main view or advanced view.



MUTE SWITCH menu item

Under the **MUTE SWITCH** menu item, you can disable the mute switch on the paired transmitter.

The transmitter can then no longer be muted.

- ▷ Open the **MUTE SWITCH** menu item.
 - ➔ The display looks as follows.

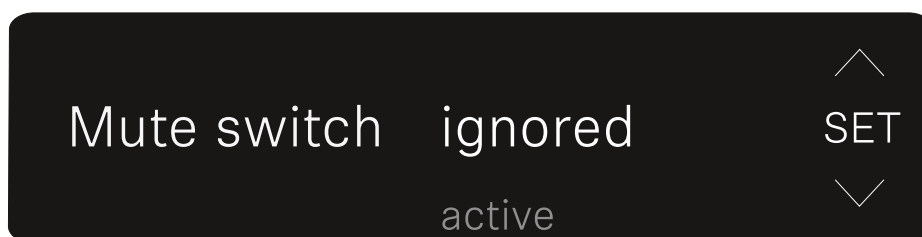

- ▷ Press the **UP** or **DOWN** button to enable (active) or disable (ignored) the function.
- ▷ Press the **SET** button to save the set value. You will then be returned to the main view or advanced view.
 - ➔ You will then be returned to the main view or advanced view.

If a loudspeaker icon within a border appears on the upper left of the display, the transmitter's mute switch is activated.

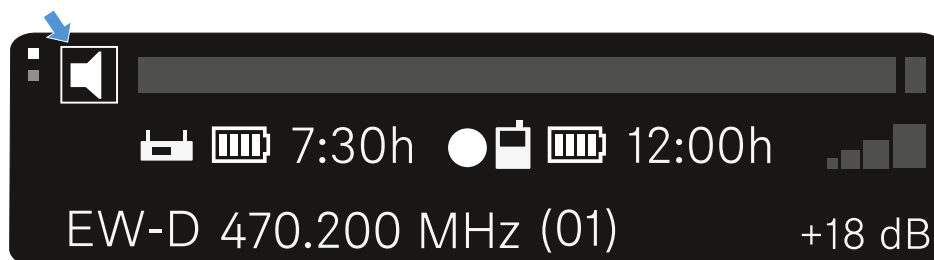



AUTO SCAN menu item

Under the **AUTO SCAN** menu item, you can perform an automatic frequency scan of your area. This enables you to easily find and assign free radio frequencies.

The scan starts at the lowest frequency in the device's frequency range.

- ▷ Open the **AUTO SCAN** menu item.
 - ➔ The scan starts automatically. The next free frequency is shown on the display.

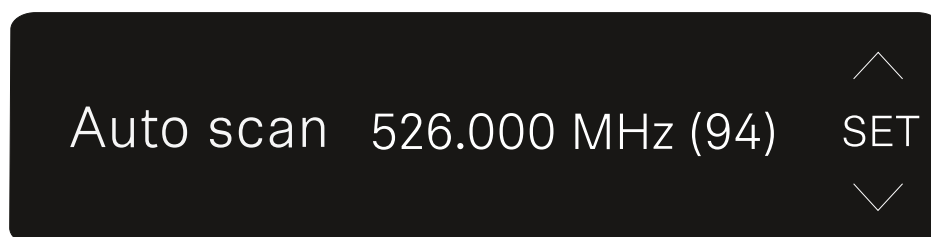

- ▷ Press the **SET** button to accept the displayed frequency.
 - Or
- ▷ Press the **UP** or **DOWN** button to display the next free frequency.
 - Or
- ▷ Press the **ESC** button to cancel the scan. The previous frequency remains unchanged.

i If you have set a new frequency, you must still synchronize the **receiver** with the **transmitter** to establish the radio link (see [Establishing a radio link | Synchronizing the receiver and transmitter](#)).



CHANNEL menu item

Under the **CHANNEL** menu item, you can set the radio frequency by selecting a preset channel.

i If you are not sure whether the selected frequency is free, we recommend performing a scan to detect all free frequencies: [AUTO SCAN menu item](#).

▷ Open the **CHANNEL** menu item.

➔ The display looks as follows.

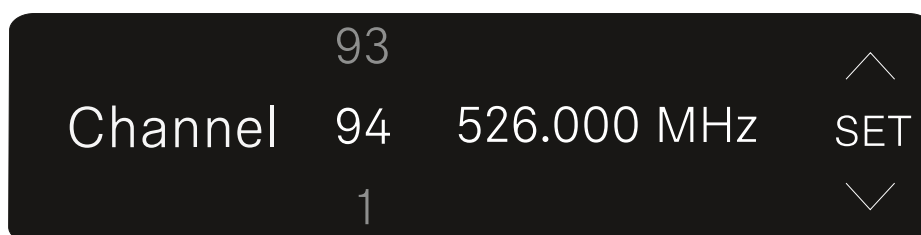

▷ Press the **UP** or **DOWN** button to select a preset channel.

▷ Press the **SET** button to accept the displayed frequency.

▷ Press the **ESC** button to cancel the scan. The previous frequency remains unchanged.

i If you have set a new frequency, you must still **synchronize the receiver with the transmitter** to establish the radio link (see [Establishing a radio link | Synchronizing the receiver and transmitter](#)).



FREQUENCY menu item

Under the **FREQUENCY** menu item, you can manually set the radio frequency independently of the preset channels.

i If you are not sure whether the selected frequency is free, we recommend performing a scan to detect all free frequencies: [AUTO SCAN menu item](#).

▷ Open the **FREQUENCY** menu item.

➔ The display looks as follows.

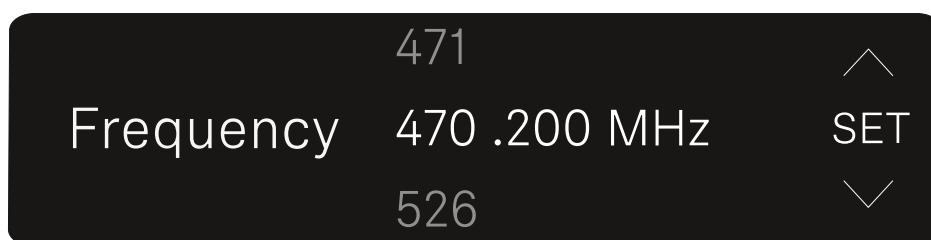

▷ Press the **UP** or **DOWN** button to set the frequency in the megahertz range.

▷ Press the **SET** button to select the value and activate fine-tuning of the frequency in the kilohertz range.

▷ Press the **UP** or **DOWN** buttons to finely adjust the frequency in the kilohertz range.

▷ Press the **SET** button to accept the displayed frequency. You will then be returned to the main view or advanced view.

Or

▷ Press the **ESC** button to cancel the scan. The previous frequency remains unchanged.

i If you have set a new frequency, you must still **synchronize the receiver with the transmitter** to establish the radio link (see [Establishing a radio link | Synchronizing the receiver and transmitter](#)).



BRIGHTNESS menu item

Under the **BRIGHTNESS** menu item, you can set the brightness of the display.

▷ Open the **BRIGHTNESS** menu item.

➔ The display looks as follows.

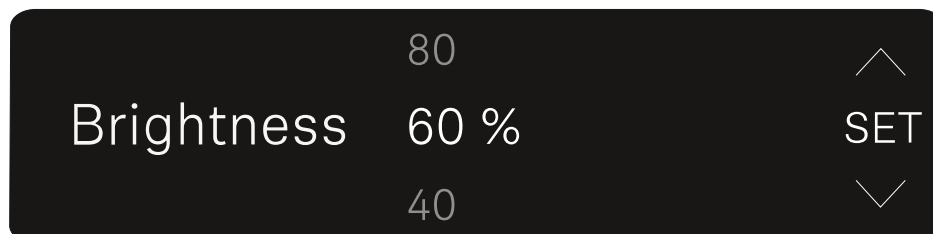

▷ Press the **UP** or **DOWN** button to set the desired brightness.

▷ Press the **SET** button to save the set value.

➔ You will then be returned to the main view or advanced view.



RESET menu item

Under the **RESET** menu item, you can reset the receiver to its factory settings.

- ▷ Open the **RESET** menu item.
 - ➔ The display looks as follows.

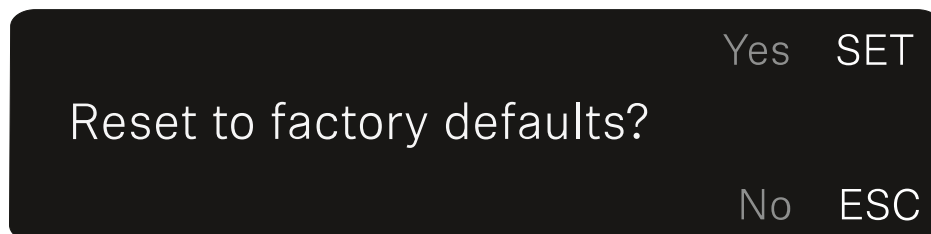

- ▷ Press the **SET** or **ESC** button to switch between the options YES and NO.
 - **YES:** The receiver is reset to its factory settings.
 - **NO:** The receiver is not reset.
- ➔ You will then be returned to the main view or advanced view.



EW-DP SKP plug-on transmitter

- Product overview
- Power supply
- Using a microSD card
- Attaching an XLR microphone
- Connecting a lavalier microphone
- Switching the plug-on transmitter on and off
- Starting/stopping recording
- MUTE mode
- Meaning of the LEDs

Product overview

Front

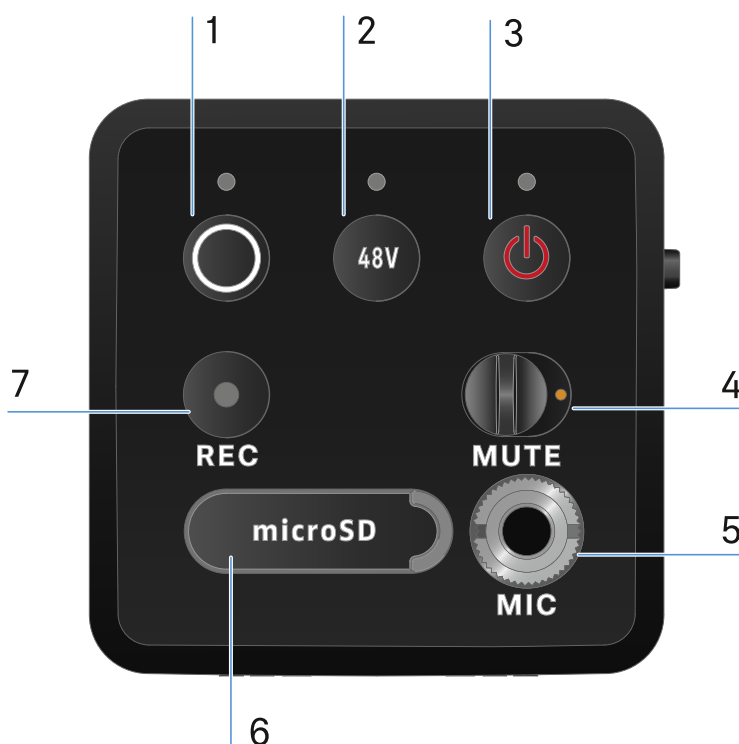



- 1 **SYNC** button for synchronizing the transmitter and receiver
 - See [Establishing a radio link | Synchronizing the receiver and transmitter](#)
 - See [Meaning of the LEDs](#)

- 2 **PHANTOM POWER** button to turn phantom power **P48** on/off
 - See [Meaning of the LEDs](#)

- 3 **ESC/ON/OFF** button for canceling an action in the menu or switching the device on and off
 - See [Switching the plug-on transmitter on and off](#)

- 4 **MUTE** switch to mute or activate the audio signal
 - See [MUTE mode](#)

- 5 3.5 mm jack input for clip-on microphones
 - See [Connecting a lavalier microphone](#)

- 6 Slot for microSD cards
 - See [Using a microSD card](#)

- 7 **REC** button
 - See [Starting/stopping recording](#)



page

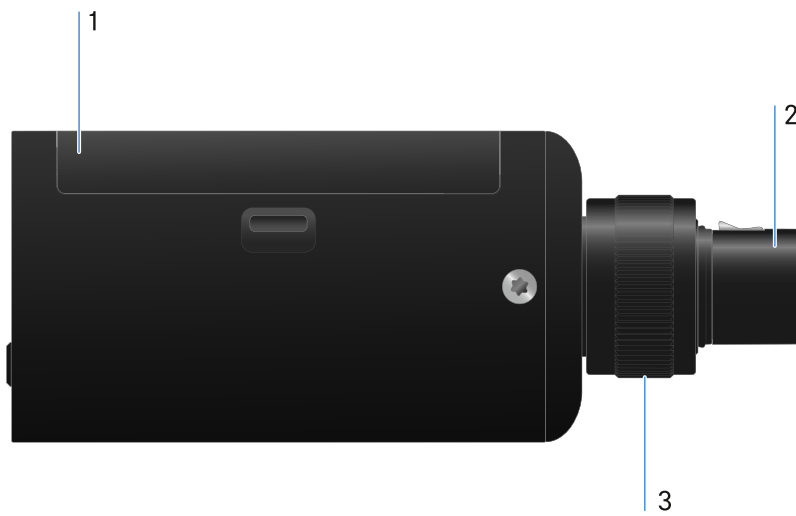

1 Battery compartment

- See [Power supply](#)

2 3-pin XLR plug

- See [Attaching an XLR microphone](#)

3 Knurled screw for fixing an XLR microphone

- See [Attaching an XLR microphone](#)



Power supply

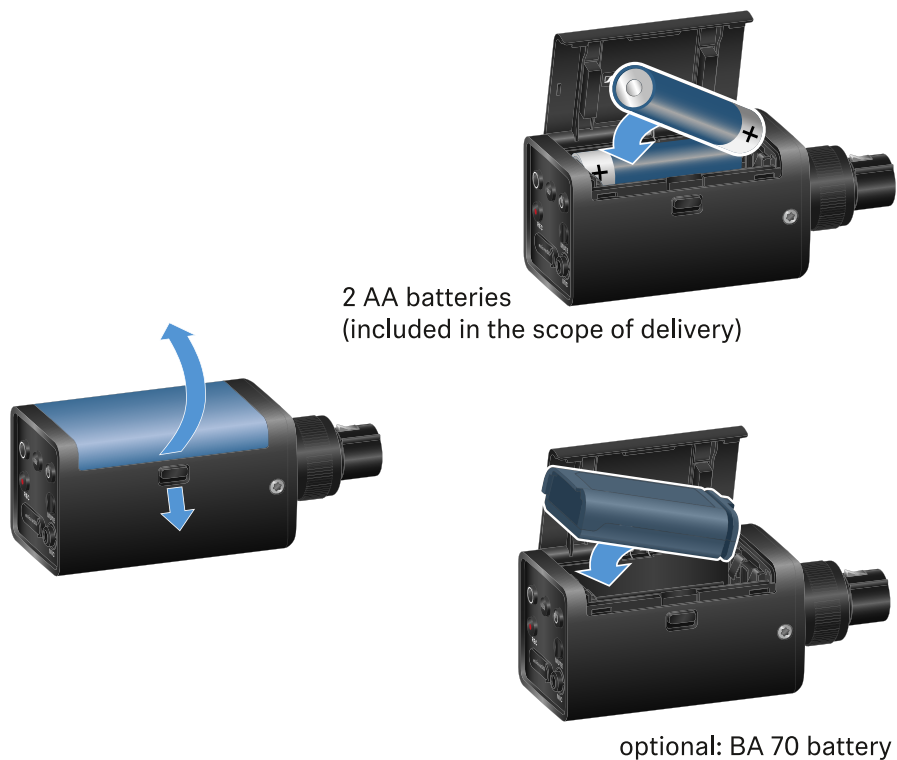

- ▷ Open the battery compartment of the EW-DP SKP by pulling down the release button and gently pulling the lid toward the release button.
 - ➔ You can now open the battery compartment.
- ▷ Insert either 2 AA batteries or a BA 70 rechargeable battery.
- ▷ Close the battery compartment.

i Removing the batteries or rechargeable battery while recording may result in a corrupted recording file.



i If stored for a long time without recharging or trickle charging, the BA 70 battery may become deep-discharged. We therefore recommend recharging the BA 70 battery after use and using trickle charging if stored for a long time.

i A deep-discharged BA 70 battery can be restored using the L 70 USB charger (article no. 508861, available separately) and then used again normally.



Using a microSD card

To insert a microSD card:

- ▷ Open the rubber lip above the card slot.
- ▷ Insert the microSD card.
- ▷ Close the rubber lip again.



- i** Removing the microSD card while recording is ongoing can result in a destroyed recording file.
- i** The EW-DP SKP supports the exFAT format.
- i** Only microSD cards with a capacity of $\leq 1\text{TB}$ are supported.
- i** We recommend formatting microSD cards in SKP before using them (for the first time).



To format the microSD card:

- ▷ Press the **REC** button for approx. 10 seconds.
- ➔ The **REC** LED flashes slowly during formatting.

i Ejecting the microSD card during an audio recording can destroy the current recording file, all existing recording files, the file system or even the entire microSD card.

- i** Recommended microSD cards:
- SanDisk Ultra 128GB Class 10 U1 (and other GBs/speeds)
 - SanDisk Extreme 128GB A2, C10, V30, U3 (and other GBs/speeds)
 - SanDisk Extreme Pro 64GB A2, U3 V30
 - SanDisk Extreme Pro 128GB A2, U3 V30
 - Samsung 128GB evo select UHS-I U3
 - Samsung 256GB evo select U3
 - Intenso 64GB 10
 - Lexar 128GB U3, A1, V30
 - Lexar 64GB U3, A1, V30
 - Lexar 32GB 633x V10b
 - Verbatim per 64GB V30 U3 C10
 - Transcend 64GB A1 U1 C10



Attaching an XLR microphone

To attach an XLR microphone to the EW-DP SKP:

- ▷ Connect the XLR microphone to the XLR connector of the plug-on transmitter.
- ▷ Secure the microphone using the knurled screw.

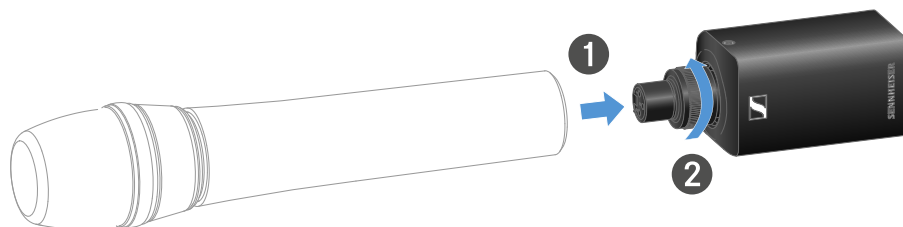



Connecting a lavalier microphone

To connect a lavalier microphone to the EW-DP SKP plug-on transmitter:

- ▷ Insert the cable's 3.5 mm jack plug into the socket on the plug-on transmitter as shown in the diagram.
- ▷ Screw the plug's coupling ring onto the audio socket thread of the plug-on transmitter.

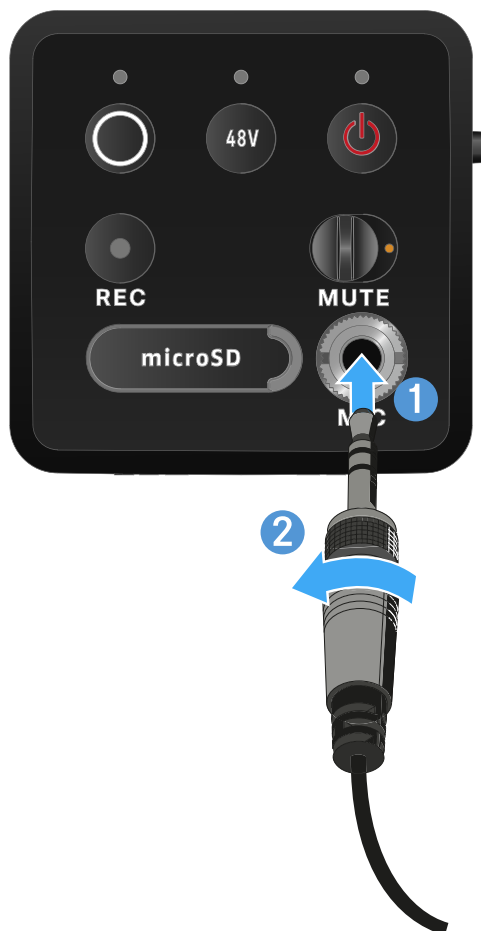



Switching the plug-on transmitter on and off

To switch the plug-on transmitter on:

- ▷ Short-press the **ON/OFF** button.
 - ➔ The plug-on transmitter switches on.



To switch the plug-on transmitter off:

- ▷ Press the **ON/OFF** button.
 - ➔ The plug-on transmitter switches off.



Starting/stopping recording

To switch the plug-on transmitter off:

- ▷ Press the **REC** button briefly for one second.
 - ➔ Recording starts.



To stop recording:

- ▷ Press the **REC** button briefly for one second.
 - ➔ Recording stops.

- i** Due to the large 134 dB dynamic range of the EW-DP SKP, the *.wav audio file recorded on the microSD card is very quiet.
- It may therefore be necessary to “normalize” the recording file with an appropriate software tool before using it.
 - We recommend increasing the audio level of the entire audio recording to the maximum peak within the recording file.
 - Instructions on how to do this are usually provided by the manufacturers of these software tools (e.g. the free software “Audacity”).



MUTE mode

You can mute the plug-on transmitter by turning off the audio signal using the MUTE switch.

i Note: If you activate the **MUTE** switch while recording, the recording continues and is not muted, even though the **MUTE** switch was activated.

▷ Slide the **MUTE** switch to the desired position to mute or activate the audio signal.





Meaning of the LEDs

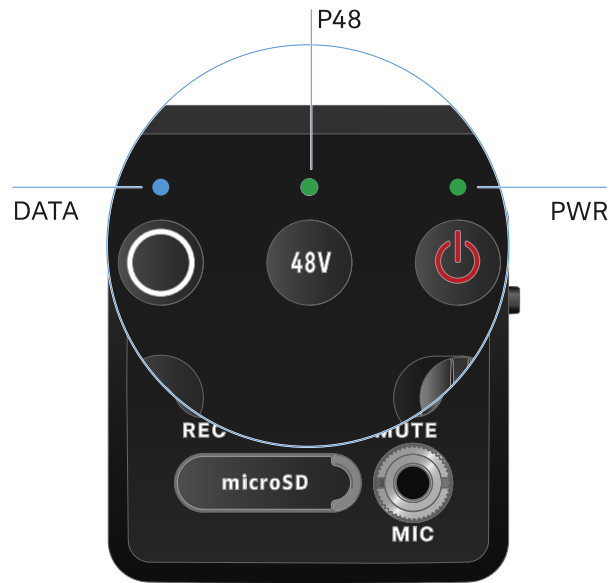

The **LINK**, **DATA** and **POWER** LEDs on the front of the receiver can indicate the following information.

PWR LED

The **PWR** LED provides information about the status of the radio link between the transmitter and receiver, as well as status information about the battery charge.



The LED is green:



- The link between the transmitter and receiver is established.
- The audio signal is active.

The LED is yellow:



- The link between the transmitter and receiver is established.
- The audio signal is muted.

The LED is flashing yellow:



- The link between the transmitter and receiver is established.
- The audio signal is overdriven (clipping).

The LED is continuously red:



- No link between the transmitter and receiver.

The LED is flashing red:



- The battery/rechargeable battery is low.

DATA LED

The **DATA** LED provides information on the receiver's **Bluetooth Low Energy** link to the **Smart Assist** app and on the synchronization of transmitters and receivers.

The LED is flashing blue:



- The **Bluetooth Low Energy** link is being established between the receiver and a smartphone or tablet with the **Smart Assist** app.



or

- The receiver is being synchronized with a transmitter.

The LED is blue:



- The firmware is being updated.

The LED is off:



- Normal operation
- There is currently no active data link.

P48 LED

The **P48** LED indicates whether phantom power P48 is activated.

The LED is green:



- phantom power P48 is active.

RECORDING LED

The **RECORDING** LED indicates the status of the recording or a possible malfunction.



The LED remains lit:



- Recording is active.

The LED flashes slowly:



- Action is in progress, such as formatting the memory card.

The LED flashes rapidly:



- Error. There are several possible reasons why an error would be displayed:
 - Memory card not inserted or faulty
 - A current recording has less than 10 minutes (= ~81 MB of disk space) of time remaining
 - Less than 3 minutes (= ~24 MB of disk space) of recording time remaining when starting a new recording (recording stops)
 - Write error
 - Buffer exceeded

i We recommend fully formatting the memory card using your PC (do not select “Quick format”).



Establishing a radio link | Synchronizing the receiver and transmitter

Information on compatibility between EW-D, EW-DX and EW-DP

	 EW-D EM	 EW-DX EM 2 EW-DX EM 2 Dante EW-DX EM 4 Dante	 EW-DP EK
 EW-D SKM-S  EW-D SK			
 EW-DX SKM EW-DX SKM-S  EW-DX SK EW-DX SK 3-PIN			
 EW-DX TS 3-pin EW-DX TS 5-pin			
 EW-DP SKP			

 The transmitter and the receiver are fully compatible with each other.

 The transmitter and the receiver are compatible with each other. Some features may not be available.



i **Conditions and restrictions for using frequencies**

There may be special conditions and restrictions for using frequencies in your country.

Before putting the product into operation, find the information for your country at the following address:

sennheiser.com/sifa

Related information

[Connecting to the EW-D EM receiver / synchronizing the EW-D EM](#)

[Connecting to the EW-DX EM receivers / synchronizing the EW-DX EM](#)

[Connecting to the EW-DP EK receiver / synchronizing the EW-DP EK](#)

Connecting to the EW-D EM receiver / synchronizing the EW-D EM

To establish a radio link between the transmitter and receiver, we recommend the following procedure.

In order to establish a connection between a receiver and transmitters of the EW-D series, the devices must always be synchronized with each other.

i To successfully connect a receiver and a transmitter, both devices must have the same frequency range.

Step 1: Set a free frequency

- ▷ We recommend using the **AUTO SCAN** function, as this is the most reliable way to identify free frequencies (see [AUTO SCAN menu item](#)).
- ▷ If you know free frequencies in your area, you can also set the frequency manually (see [CHANNEL menu item](#) or [TUNE menu item](#)).



Step 2: Pairing a receiver with a transmitter

- ▷ Short-press the **SYNC** button on the receiver.
 - ➔ The blue **DATA** LED flashes.



- ▷ Short-press the **SYNC** button on the transmitter.
 - ➔ The blue **DATA** LED flashes.

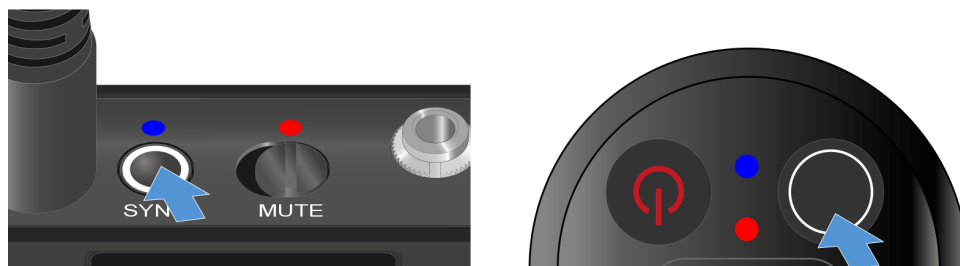

- ✓ The transmitter and receiver will be paired. Once the link is established, the **LINK** LED on both units will light up green.

i Be sure to press the **SYNC** button on all devices only briefly (less than 2 seconds). Holding the **SYNC** button longer than this will start the firmware update mode and cancel the synchronization process.



Connecting to the EW-DX EM receivers / synchronizing the EW-DX EM

Receiver: EW-DX EM 2 | EW-DX EM 2 Dante | EW-DX EM 4 Dante

To establish a radio link between the transmitter and receiver, we recommend the following procedure.

In order to establish a connection between a receiver and transmitters of the EW-D series, the devices do not necessarily have to be synchronized with each other.

i To successfully connect a receiver and a transmitter, both devices must have the same frequency range.

Step 1: Set a free frequency

- ▷ We recommend using the AUTO SCAN function, as this is the most reliable way to identify free frequencies (see [Ch 1 / Ch 2 -> Scan / Auto Setup menu item](#)).
- ▷ If you know free frequencies in your area, you can also set the frequency manually.
 - EW-DX EM 2: [Ch 1 / Ch 2 -> Frequency menu item](#)
 - EW-DX EM 2 Dante: [Ch 1 / Ch 2 -> Frequency menu item](#)
 - EW-DX EM 4 Dante: [Ch 1 - Ch 4 -> Frequency menu item](#)
 - EW-DX SKM(-S): [Opening the menu and navigating the menu items](#)
 - EW-DX SK (3-PIN): [Opening the menu and navigating the menu items](#)

Once you have set the same frequency for the desired receiving channel on the receiver and for the transmitter you want to connect, the radio link is established.

To ensure that all settings are transmitted to the transmitter, we recommend synchronizing the transmitter with the receiving channel.

Step 2: Synchronizing the receiver and transmitter

- ▷ On the EW-DX EM 2 and EW-DX EM 2 Dante receivers, press the **CH 1** or **CH 2** button, and on the EW-DX EM 4 Dante receiver, press the **CH 1**, **CH 2**, **CH 3** or **CH 4** button to select the channel for synchronization.

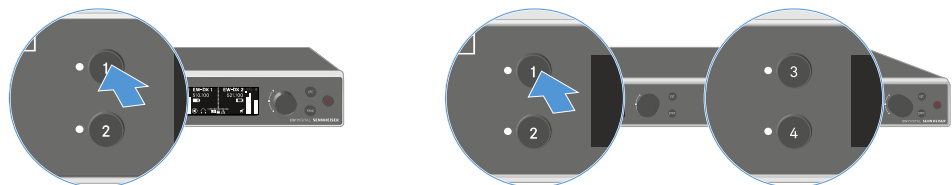



▷ Press the **SYNC** button on the receiver.



➔ The receiver's display shows that the synchronization process has started.

The blue DATA LED flashes.



▷ Short-press the **SYNC** button on the transmitter.

➔ The blue **DATA** LED flashes.



✓ The transmitter and receiver will be synchronized.



Connecting to the EW-DP EK receiver / synchronizing the EW-DP EK

To establish a radio link between the transmitter and receiver, we recommend the following procedure.

In order to establish a connection between a receiver and transmitters of the EW-DP EK series, the devices must always be synchronized with each other.

i To successfully connect receivers and transmitters, both devices must have the same frequency range.

Step 1: Set a free frequency

- ▷ We recommend using the **AUTO SCAN** function, as this is the most reliable way to identify free frequencies (see [AUTO SCAN menu item](#)).
- ▷ If you know free frequencies in your area, you can also set the frequency manually (see [CHANNEL menu item](#) or [FREQUENCY menu item](#)).

Step 2: Pairing a receiver with a transmitter

- ▷ Short-press the **SYNC** button on the receiver.
 - ➔ The blue **DATA** LED flashes.

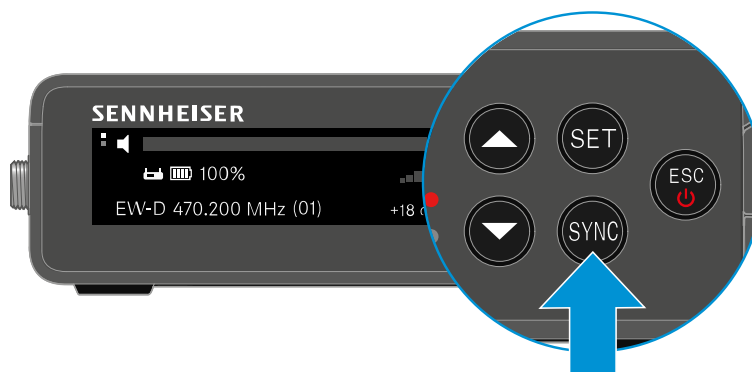

- ▷ Short-press the **SYNC** button on the transmitter.
 - ➔ The blue **DATA** LED flashes.





- ✓ The transmitter and receiver will be paired. Once the link is established, the **LINK** LED on both units will light up green.

i Be sure to press the **SYNC** button on all devices only briefly (less than 2 seconds). Holding the **SYNC** button longer than this will start the firmware update mode and cancel the synchronization process.



L 70 USB charger

Connecting/disconnecting the charger to/from the power supply system
Charging the rechargeable battery

Connecting/disconnecting the charger to/from the power supply system

To connect the charger to the power supply system:

- ▷ Use only the **NT 5-20 UCW** power supply unit from Sennheiser.
- ▷ Connect the USB-C plug on the charging cable to the USB-C port on the side of the charger.
- ▷ Plug the power supply unit with the correct country adapter into a suitable power outlet.

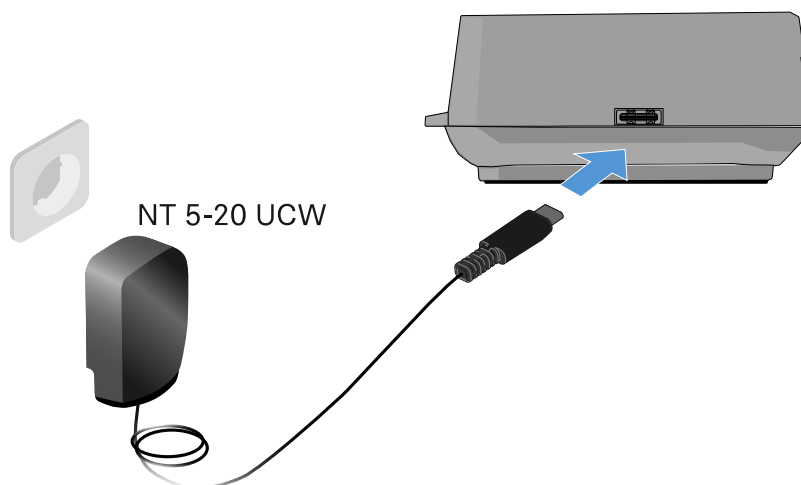

To disconnect the charger from the power supply system:

- ▷ Unplug the power supply unit from the wall socket.
- ▷ Remove the USB-C plug on the charging cable from the USB-C port on the side of the charger.



Charging the rechargeable battery

To charge the BA 70 rechargeable battery in the L 70 USB charger:



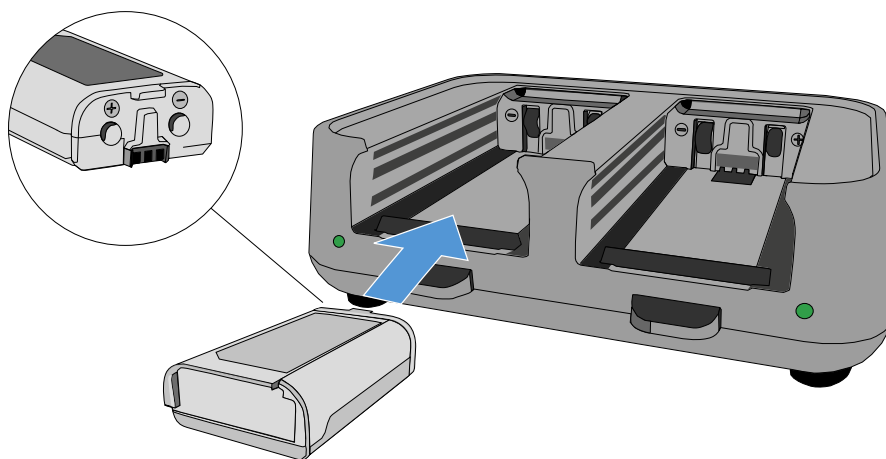



- ▷ Slide the rechargeable battery completely into the charging slot as shown in the figure.



- ➔ The rechargeable battery will begin charging.

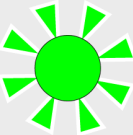

The LED on the charging slot shows the battery's charge level:

LEDs	
	100 %
	> 60 %
	> 20 %
	> 0 %
	Error



CHG 70N-C charger

Charge the EW-DX SKM/EW-DX SKM-S handheld transmitter, the EW-DX SK/EW-DX SK 3-PIN bodypack transmitter or the BA 70 rechargeable battery in the CHG 70N-C charger.

- [Product overview](#)
- [Connecting/disconnecting the charger to/from the power supply system](#)
- [Connecting a charger in a network](#)
- [Cascading chargers](#)
- [Charging the rechargeable battery](#)
- [Power saving mode](#)

Product overview

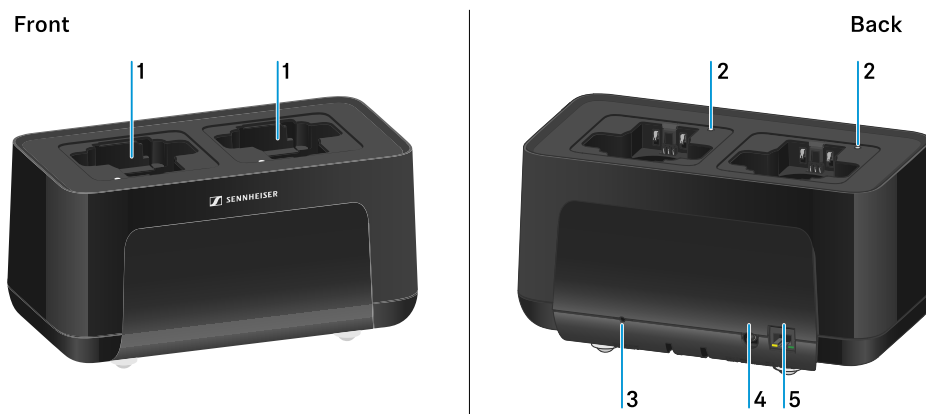

1 Charging slots

- See [Charging the rechargeable battery](#)

2 Status LED of the charging slots

- See [Charging the rechargeable battery](#)

3 Reset button

- Press and hold for 10 seconds to reset the device's network settings, see [Connecting a charger in a network](#)
- Press and hold for 4 seconds to enable power saving mode, see [Power saving mode](#)



4 DC in connection socket for the **NT 12-35 CS** power supply unit

- See [Connecting/disconnecting the charger to/from the power supply system](#)

5 PoE/Ethernet RJ-45 socket for controlling the device over the network and for Power over Ethernet power supply

- See [Connecting a charger in a network](#)
- See [Connecting/disconnecting the charger to/from the power supply system](#)

i You can cascade up to 5 devices with only one power supply and one network connection. See [Cascading chargers](#).



Connecting/disconnecting the charger to/from the power supply system

You can operate the charger either with the Sennheiser NT 12-35 CS power supply unit or with Power over Ethernet (PoE IEEE 802.3af Class 0). Please refer to the following information.

Power from the NT 12-35 CS power supply unit

- ▷ Use only the **NT 12-35 CS** power supply unit from Sennheiser. It is designed for your charger and ensures safe operation.

i The power supply unit is available either separately (Sennheiser article number 508995) or together with the charger as a kit (see [CHG 70N-C network-enabled charger](#)).

Power from the NT 12-35 CS power supply unit

i Use only the **NT 12-35 CS** power supply unit from Sennheiser. It is designed for your charger and ensures safe operation. The power supply unit is available either separately (Sennheiser article number 508995) or together with the charger as a kit (see [CHG 70N-C network-enabled charger](#)).

- ▷ Connect the hollow jack plug of the power supply unit to the **DC in** socket on the charger.
- ▷ Pass the cable through the strain relief.
- ▷ Plug the power supply unit into the wall outlet using the correct power cable for your country.

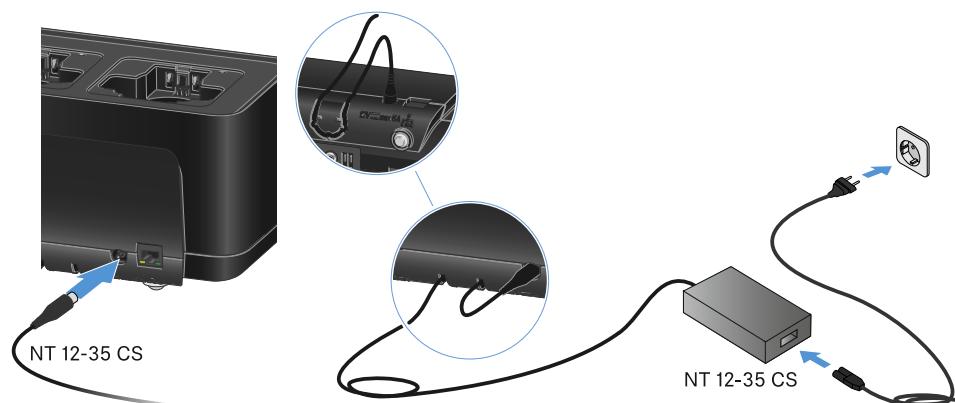



Disconnecting the charger completely from the power supply system

- ▷ Unplug the mains cable from the wall socket.
- ▷ Unplug the hollow jack plug of the power supply unit from the **DC in** socket on the charger.

Power over Ethernet (PoE)

i The charger can be powered via **Power over Ethernet** (PoE IEEE 802.3af Class 0).

- ▷ Connect the charger to a **PoE**-enabled network switch.

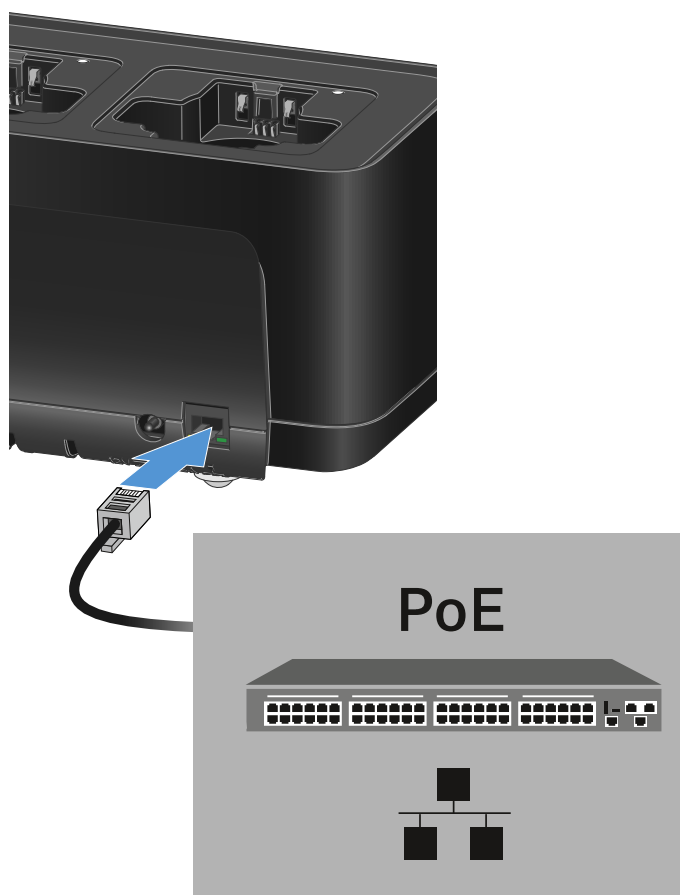



Connecting a charger in a network

You can monitor and control one or more chargers via a network connection using the **Sennheiser Wireless Systems Manager (WSM)** or **Sennheiser Control Cockpit (SCC)** software.

- i** The network does not have to be a homogeneous network including only chargers. You can integrate the charger into your existing network infrastructure with any other types of devices.

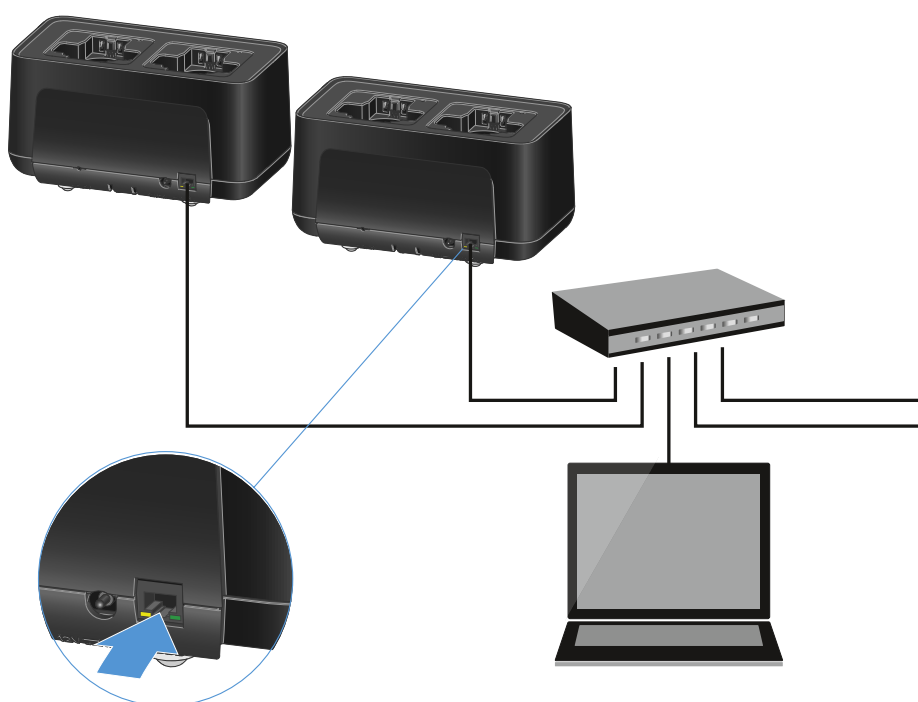

You can integrate the devices into the network individually or cascade up to 5 chargers (see [Cascading chargers](#)).

To reset the network settings to their factory defaults:

- ▷ Hold the **Reset** button for 4 seconds.



i For more information about controlling devices via the Sennheiser Wireless Systems Manager or Sennheiser Control Cockpit software, refer to the instruction manual for the software. You can download the software here:

sennheiser.com/wsm

sennheiser.com/control-cockpit-software



Cascading chargers

You can cascade up to five CHG 70N-C chargers and operate them with a single power supply and a single network connection. This minimizes the cabling required for larger systems.

- i** The power must be supplied via the NT 12-35 CS power supply unit. Power over Ethernet (PoE) is not possible when cascading.

To cascade the chargers:

- ▷ Make sure that no chargers are connected to the power before you start.
- ▷ Plug the chargers into each other as shown in the figure.

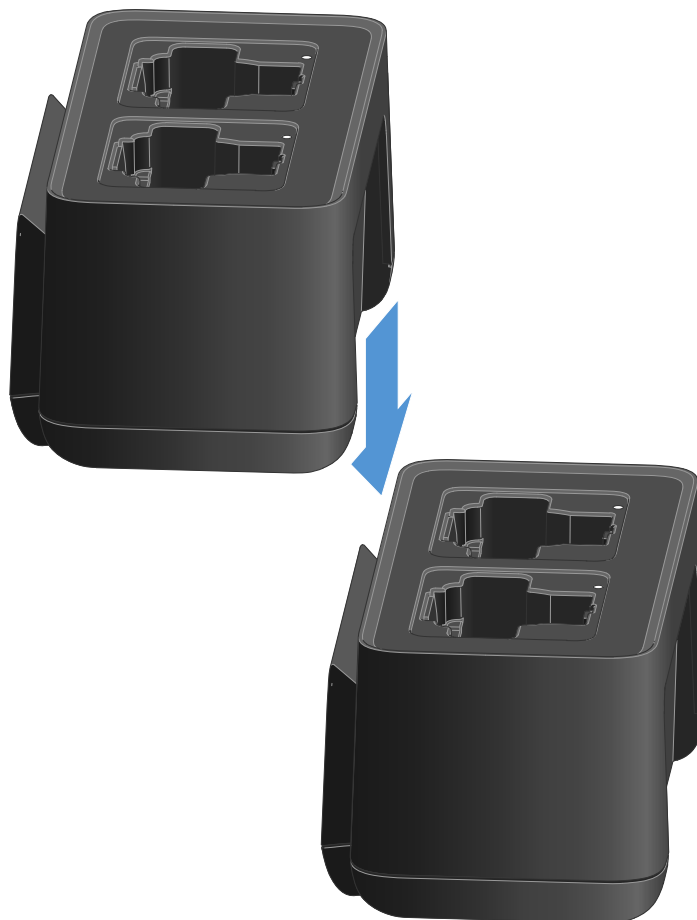

- ▷ Detach the connecting rail on the bottom of the charger.
- ▷ Fasten the connecting rail beneath two chargers as shown in the figure.



➔ The power and the network connection are passed on to all devices via the connecting rails.

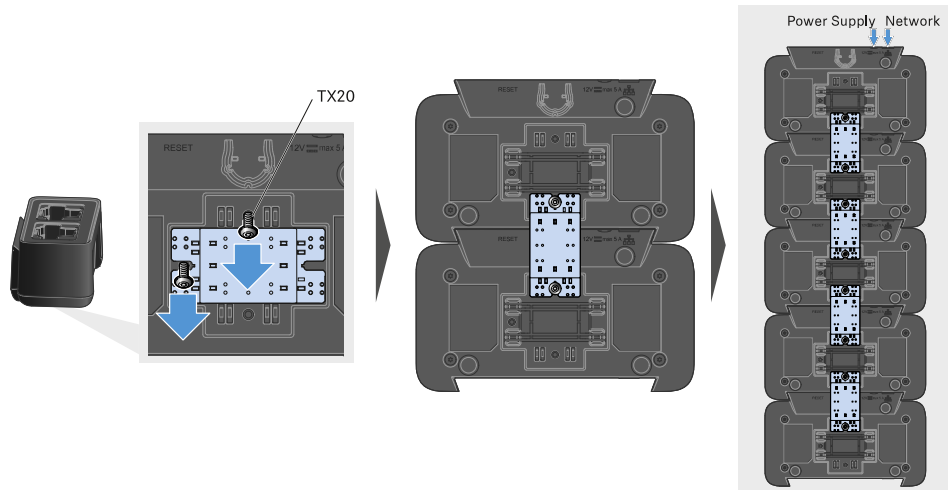

- ▷ Connect the first charger in the cascade to the network (see [Connecting a charger in a network](#)).
- ▷ Finally, connect the NT 12-35 CS power supply unit to the first charger in the cascade (see [Connecting/disconnecting the charger to/from the power supply system](#)).

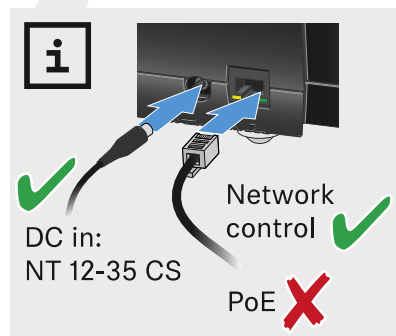



Charging the rechargeable battery

You can use the CHG 70N-C charger to charge individual BA 70 rechargeable batteries, or to charge EW-DX SKM, EW-DX SKM-S, EW-DX SK or EW-DX SK 3-PIN transmitters with the BA 70 rechargeable battery already inserted.

To charge the battery:



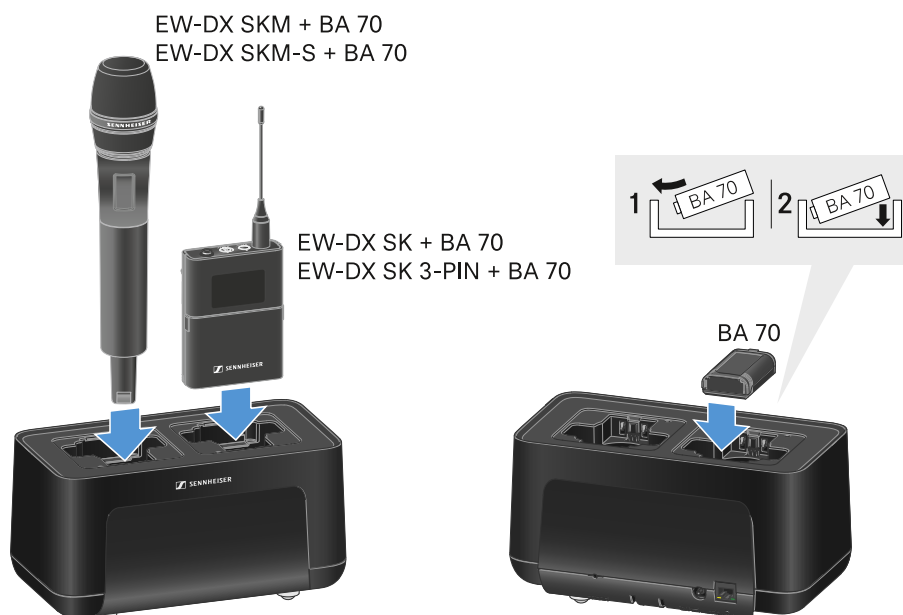



- ▷ Insert the individual rechargeable battery or the transmitter with battery already inserted into the charging slot as shown in the figure.



➔ The rechargeable battery will begin charging.

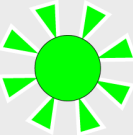

The LED on the charging slot shows the battery's charge level.

LEDs	
	100 %
	> 60 %
	> 20 %
	> 0 %
	Error



Power saving mode

In power saving mode, the transmitters are charged only once. The charger also does not provide any trickle charge.

To activate power saving mode:

i In power saving mode, the CHG 70N-C cannot be controlled over the network.

- ▷ Remove all transmitters and/or rechargeable batteries from the charging slots.
- ▷ Hold the **Reset** button for 4 seconds.
 - ➔ The charging slot LEDs light up purple.
- ▷ Insert the rechargeable battery/transmitter for charging.
 - ➔ The rechargeable battery will begin charging. The charging slot LED turns green once it reaches full charge.

To deactivate power saving mode:

- ▷ Disconnect the charger from the power supply system.
- ▷ Then reconnect it to the power supply system.
 - ➔ The charger will start up in the configuration that was set before you activated power saving mode.



EW-D ASA antenna splitter

Product overview

- Connecting/disconnecting the EW-D ASA to/from the power supply system
- Connecting receivers to the EW-D ASA
- Connecting antennas
- Information on antenna amplifiers and cable lengths
- Configuring multi-channel systems
- Installing the EW-D ASA in a rack
- Switching the EW-D ASA on and off

Product overview

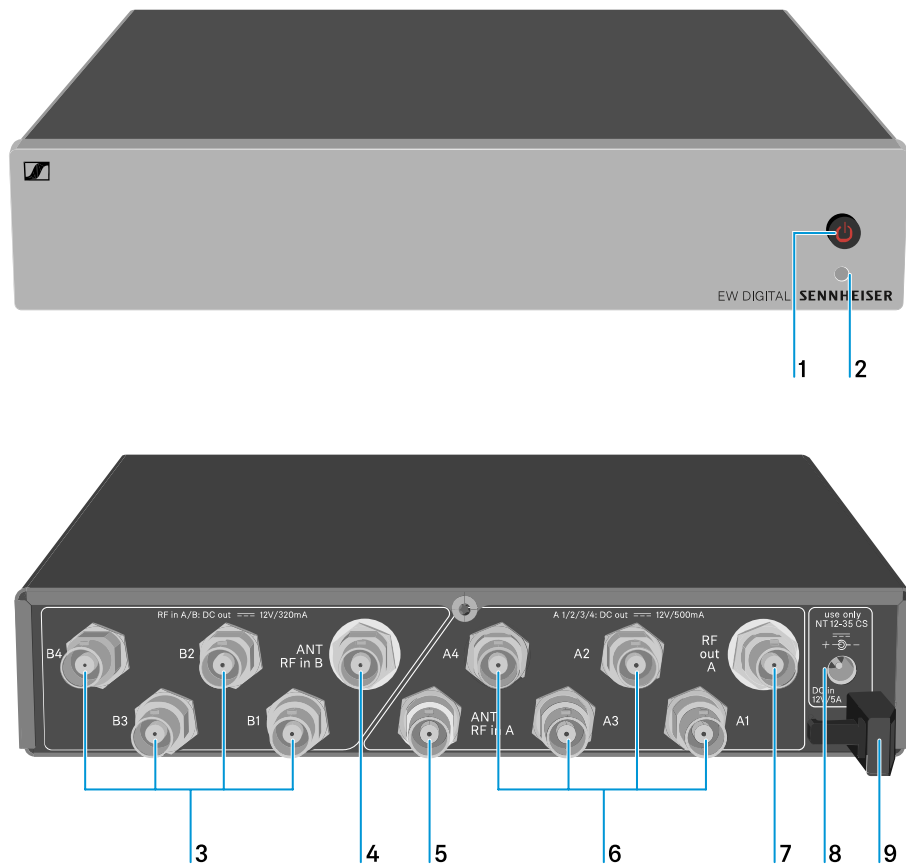

1 **STANDBY** button

- See [Switching the EW-D ASA on and off](#)



2 LED: Operation indicator

- See [Switching the EW-D ASA on and off](#)

3 4 BNC sockets **B1** to **B4**

- RF outputs of diversity branch B for connection to the receiver
- See [Connecting receivers to the EW-D ASA](#)

4 **ANT RF IN B** BNC socket

- Antenna input of diversity branch B
- See [Connecting antennas](#)

5 **ANT RF IN A** BNC socket

- Antenna input of diversity branch A
- See [Connecting antennas](#)

6 4 BNC sockets **A1** to **A4**

- RF outputs of diversity branch A for connection to the receiver
- Each one of these RF outputs can also provide power to an EW-D EM receiver
- See [Connecting receivers to the EW-D ASA](#)

7 **RF OUT A** BNC socket

- RF output only for connecting an additional ASA 214 to build an 8-channel diversity system
- See [Configuring multi-channel systems](#)

8 **DC in** socket

- To connect the NT 12-35 CS power supply unit
- See [Connecting/disconnecting the EW-D ASA to/from the power supply system](#)

9 Strain relief for the connection cable of the power supply unit

- See [Connecting/disconnecting the EW-D ASA to/from the power supply system](#)



Connecting/disconnecting the EW-D ASA to/from the power supply system

To supply power to the EW-D ASA, the connected receivers (EW-D EM only) and any antenna amplifiers used, you will need the NT 12-35 CS power supply unit.

Use only the supplied NT 12-35 CS power supply unit. It is designed for your antenna splitter and ensures safe operation.

To connect the EW-D ASA antenna splitter to the power supply system:

- ▷ Plug the hollow jack plug of the power supply unit into the **DC in** socket of the antenna splitter.
- ▷ Pass the cable of the power supply unit through the strain relief.
- ▷ Connect one end of the power cord to the power supply unit and the other end to the wall socket.

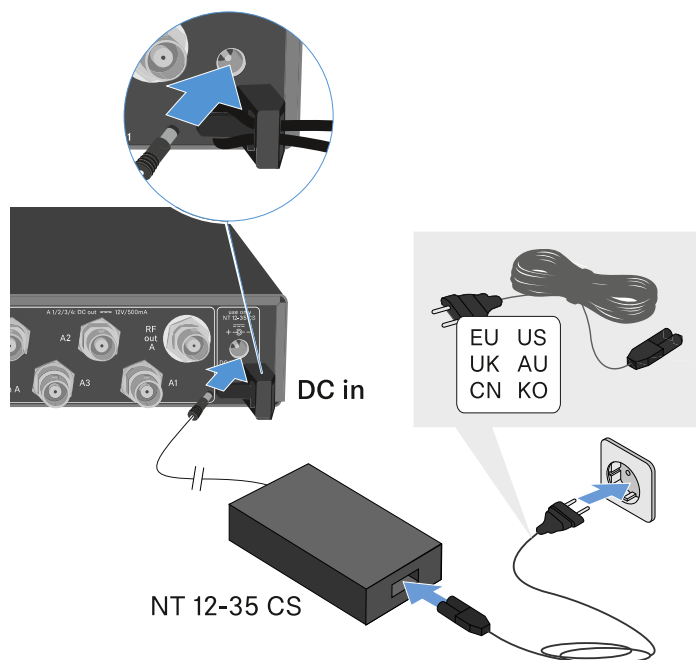

To completely disconnect the EW-D ASA antenna splitter from the power supply system:

- ▷ Unplug the power cable from the wall socket.
- ▷ Unplug the hollow jack plug of the power supply unit from the **DC in** socket of the antenna splitter.



Connecting receivers to the EW-D ASA

You can connect and operate up to four EW-D EM or EW-DX EM 2 rack receivers with the EW-D ASA.

To connect the receivers to the EW-D ASA antenna splitter:

▷ Connect one of the receiver's antenna inputs to one of the BNC sockets **A1** to **A4** using one of the supplied BNC cables.

➔ The **EW-D EM** receivers do not require their own power supply. They are powered via the BNC sockets **A1** to **A4**.

i The **EW-DX EM 2** receivers cannot be supplied with power via the BNC sockets. They need to be powered by the included power supply unit or by PoE.

▷ Connect the receiver's other antenna input to one of the BNC sockets **B1** to **B4** using one of the supplied BNC cables.

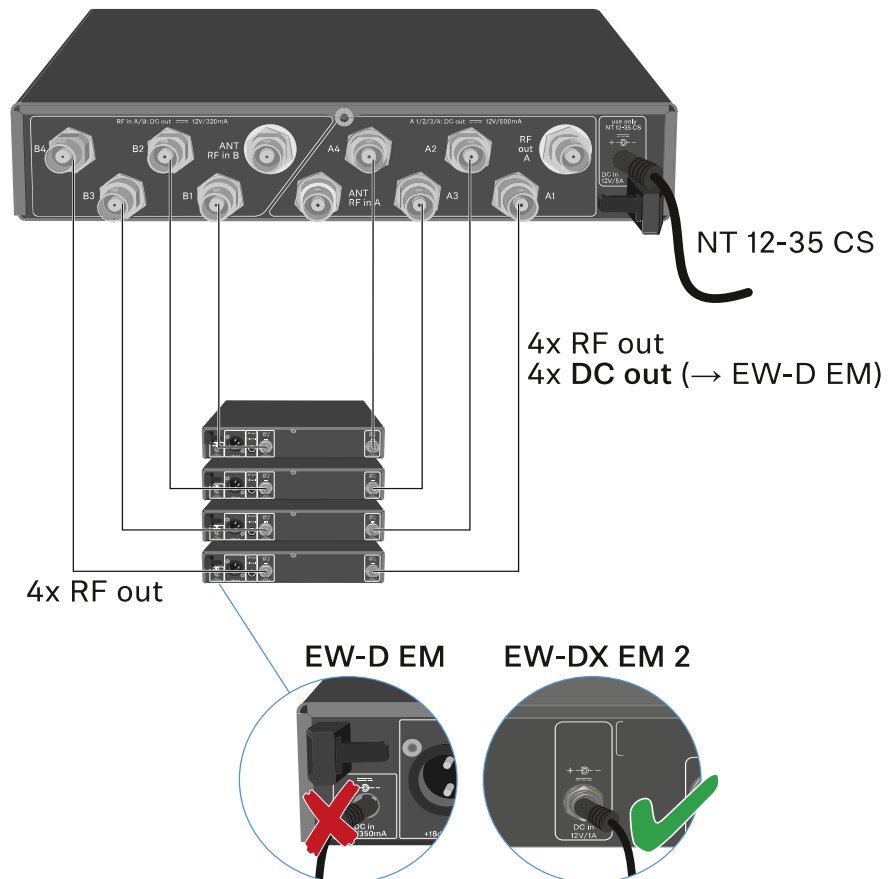



Connecting antennas

- i** To ensure optimal reception even in the case of poor reception conditions, we recommend using remote antennas.

Connecting remote antennas

- ▷ Mount an antenna each or a combination of an antenna and an antenna amplifier to the BNC sockets **ANT RF IN A** and **ANT RF IN B**.
- ▷ Refer to the instructions under [Information on antenna amplifiers and cable lengths](#).

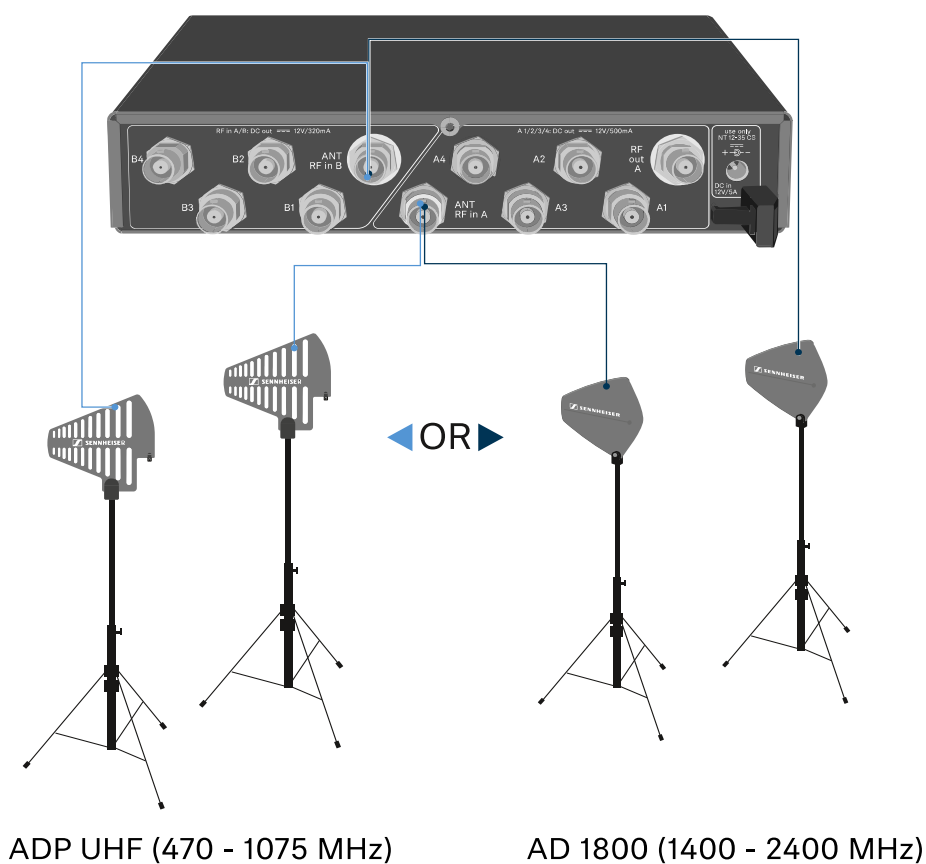

Connecting rod antennas

- ▷ Mount the antennas to the BNC sockets **ANT RF IN A** and **ANT RF IN B**.
- ▷ Align the antennas in a V-shape in order to ensure the best possible reception.



Information on antenna amplifiers and cable lengths

The following table shows which cable lengths require the use of the **EW-D AB** antenna amplifier as well as the maximum recommended cable lengths.

Frequency range around	Number of EW-D AB	Max. cable length RG 58	Max. cable length GZK 5000
500 MHz	0	8 m	16 m
	1	36 m	72 m
	2	64 m	128 m
700 MHz	0	7 m	14 m
	1	30 m	60 m
	2	53 m	106 m
900 MHz	0	6 m	12 m
	1	26 m	52 m
	2	46 m	92 m
1800 MHz	0	4 m	8 m
	1	16 m	36 m
	2	28 m	64 m

i For frequency variants of the EW-D AB, see [EW-D AB antenna splitter](#).



Configuring multi-channel systems

The following options for connecting multi-channel systems are possible:

Option 1: Two antennas supply a 4-channel system

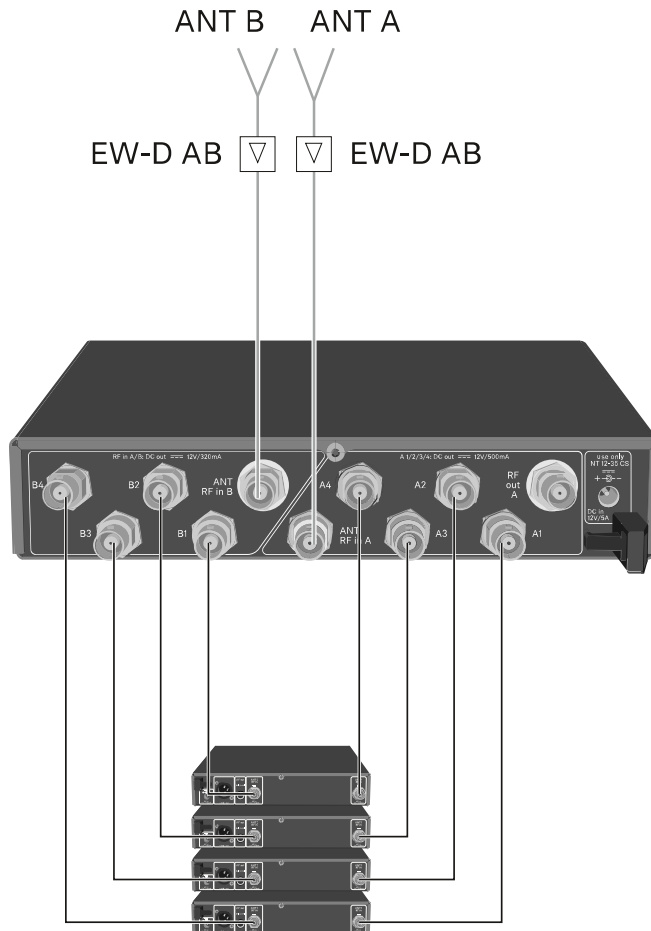



Option 2: Two 4-channel systems are interconnected

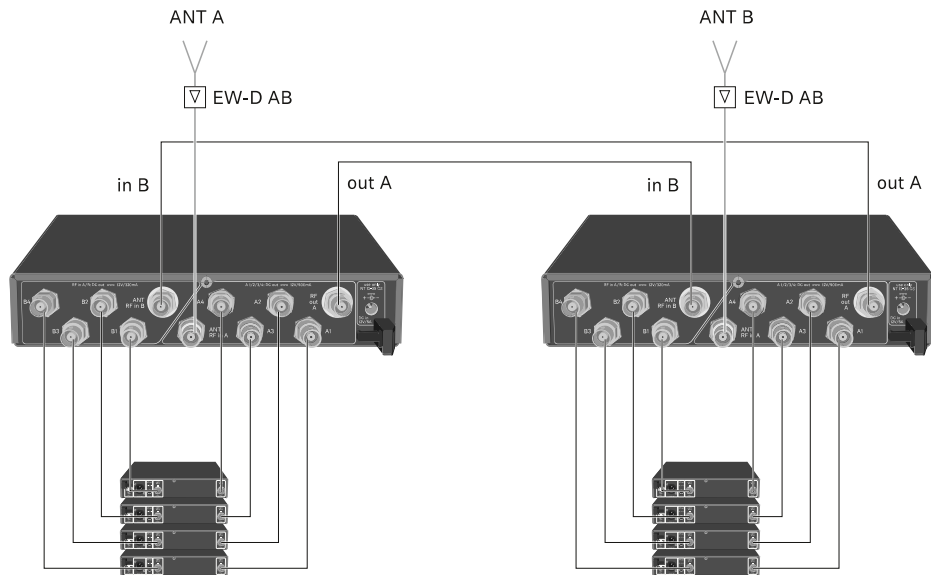

Option 3: Two antennas supply a 8-channel system

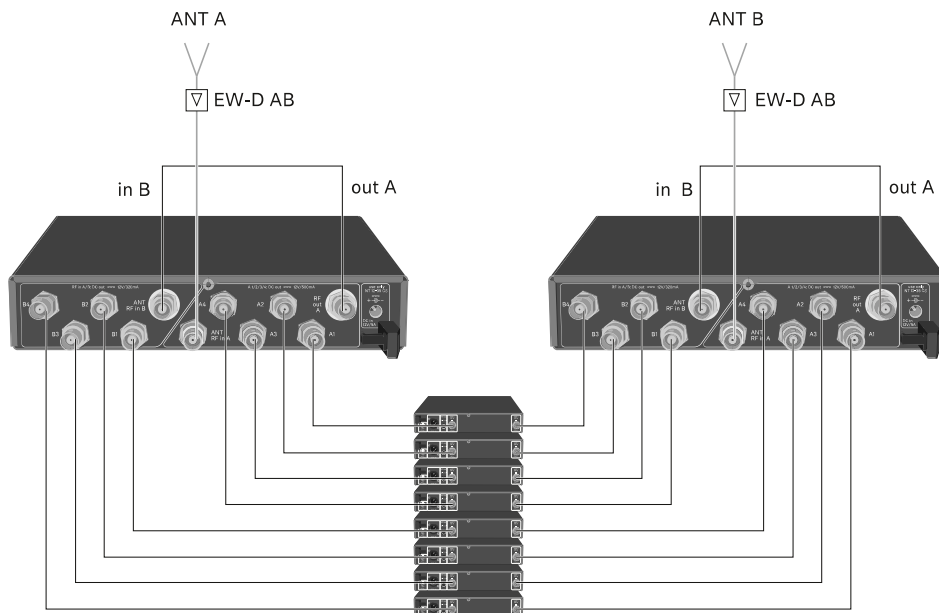



Installing the EW-D ASA in a rack

NOTICE



Rack mounting poses risks!

When installing the device in a closed 19" rack or multi-rack assembly, please consider that, during operation, the ambient temperature, the mechanical load and the electrical potentials will be different from those of devices which are not mounted into a rack.

- ▷ Make sure that the ambient temperature within the rack does not exceed the permissible temperature limit stated in the specifications. See ([Specifications](#)).
- ▷ Ensure sufficient ventilation; if necessary, provide additional ventilation.
- ▷ Make sure that the mechanical load of the rack is even.
- ▷ When connecting to the power supply system, observe the information indicated on the type plate. Avoid overloading the circuits. If necessary, provide overcurrent protection.
- ▷ When mounting in a rack, please note that intrinsically harmless leakage currents of the individual power supply units may accumulate, thereby exceeding the permissible limit value. As a remedy, ground the rack via an additional ground connection.

To mount the antenna splitter in a rack, you will need the GA 3 rack mount kit (optional accessory).

- ▷ Rack mounting is carried out in the same way as for the EW-D EM receiver: see [Installing receivers in a rack](#).



Switching the EW-D ASA on and off

To switch on the antenna splitter:

- ▷ Short-press the **STANDBY** button.



- ➔ The antenna splitter switches on and the power LED turns green.

The RF signals of the connected antennas are distributed to all connected receivers.

To switch the antenna splitter to standby mode:

- ▷ Press the **STANDBY** button for approx. 2 seconds.
 - ➔ The LED turns off. The connected antenna amplifiers are switched off. Connected receivers are switched off if they draw their supply voltage from the BNC sockets A1 to A4 (see [Connecting receivers to the EW-D ASA](#)).

To fully switch off the antenna splitter:

- ▷ Disconnect the antenna splitter from the power supply system by unplugging the power supply unit from the wall socket.
 - ➔ The LED turns off.



AWM active directional antenna

- [Product overview](#)
- [Antenna setup](#)
- [Connecting the cable to the antenna](#)
- [Recommended cable lengths](#)
- [Installing and mounting the antenna](#)
- [Mounting the antenna on the wall](#)
- [Mounting the antenna on the ceiling](#)
- [Mounting the antenna on a stand](#)
- [Mounting the antenna on a VESA mount](#)
- [Setting the gain](#)
- [GAIN LED](#)

Product overview

Front

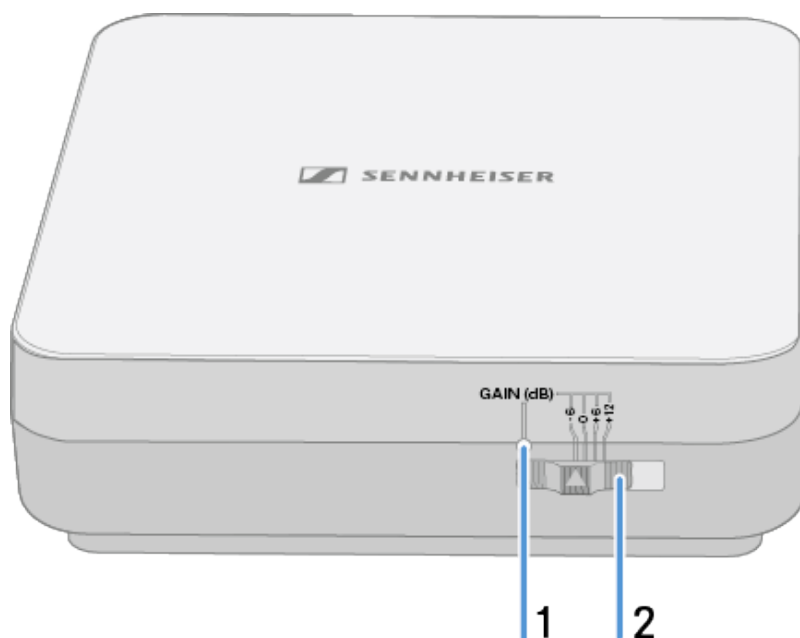

1 Gain LED

- See [Setting the gain](#)



2 Gain switch

- See [Setting the gain](#)

Bottom

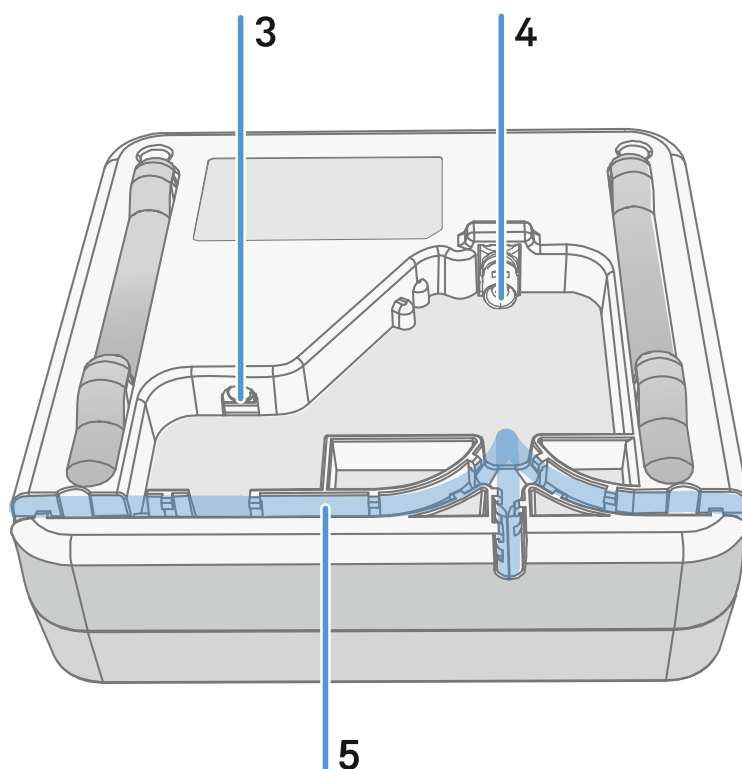

3 DC in connection socket for the power supply unit

- See [Connecting the cable to the antenna](#)

4 BNC socket for **RF out**

- See [Connecting the cable to the antenna](#)

5 Wiring duct

- See [Connecting the cable to the antenna](#)



Mounting frame and drilling template

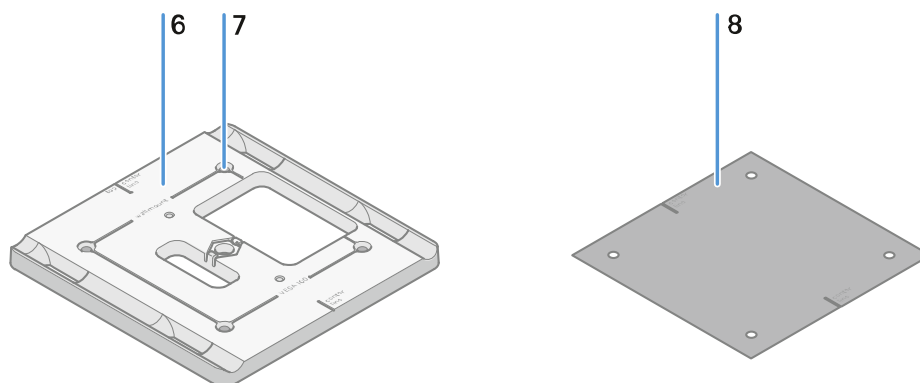

6 Mounting frame

- See [Installing and mounting the antenna](#)

7 Hole

- $\varnothing 5.5$ mm

8 Drilling template

- See [Installing and mounting the antenna](#)



Antenna setup

Instructions for optimum interaction with Sennheiser transmitters (system polarization)

Recommended setups depending on the antennas – polarization:

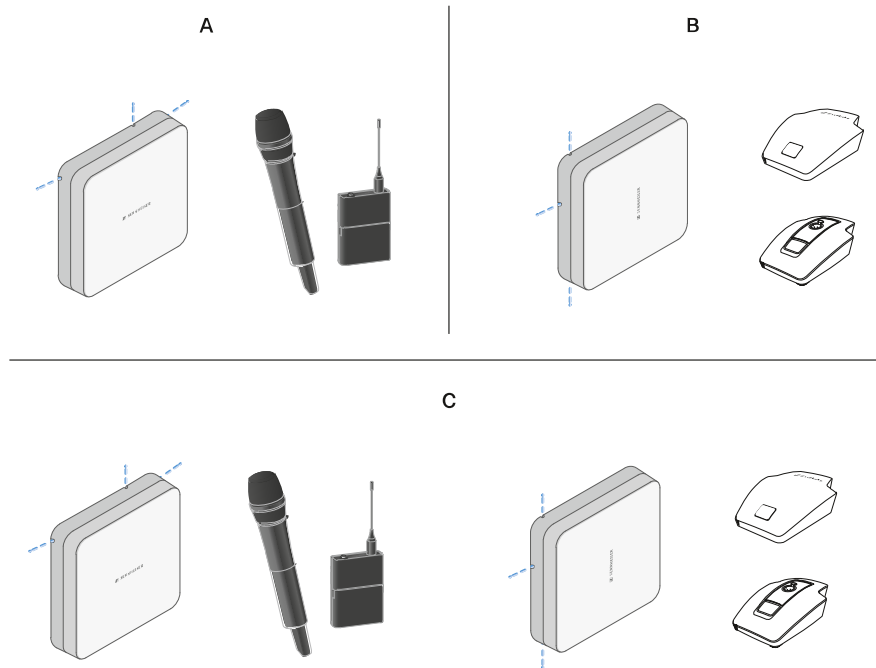

A Vertical (normal orientation)

- Suitable for hand-held or bodypack transmitters

B Horizontal (rotated orientation)

- Suitable for table stands

C Vertical and horizontal (mixed orientation)

- Suitable for mixed transmitter types



Connecting the cable to the antenna

Information on connecting the antenna:

- Observe the recommended cable lengths, see [Recommended cable lengths](#).
- The cable diameter must be <6 mm to fit in the cable sheath.
- Observe the length of the cable within the antenna, see [Cable sheath options](#).
- The DC connection is optional and provides an alternative to the DC supply via the BNC cable.
 - The EW-DX EM 4 Dante and EW-D ASA devices supply the antenna with voltage via the BNC cable, meaning no additional DC supply is required.
 - With the EW-D EM, EW-DX EM 2 and EW-DX EM 2 Dante devices, a power supply via the DC connection is required.

i The antenna is supplied with power via the RF or DC cable. As soon as the power supply is established, the antenna switches on automatically. There is no separate on/off switch.

To connect the cable to the antenna:

- ▷ If necessary, connect the DC cable to the **DC in** socket.

i We recommend using the EW-D power supply unit (art. no. 509454).

- ▷ Run the cable out to one side.
- ▷ Connect the RF cable to the **RF in** socket.
- ▷ Run the cable out to the same side.

i Alternatively, you can connect the cables through an opening in the wall.

Cable sheath options:



The cable sheath enables optimum antenna characteristics and also enables a plastic cable duct to be laid to discreetly conceal the cables directly up to the antenna housing.

- **A** RF cable length in the antenna >205 mm
- **B** RF cable length in the antenna >110 mm
- **C** RF cable length in the antenna >140 mm

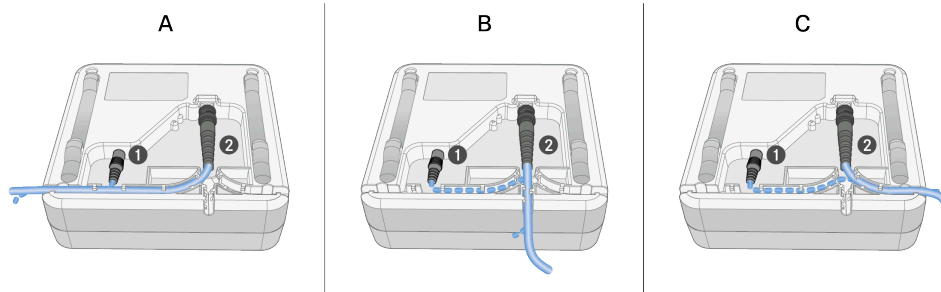



Recommended cable lengths

To ensure reliable operation, observe the following **maximum antenna cable lengths** and adjust the gain accordingly:

i Note the corresponding values in the data sheet of the antenna cable used.

Frequency range around	Gain	Max. cable length RG 58	Max. cable length GZL RG 8x
500 MHz	-6 dB	4.5 m	9 m
	0 dB	9 m	18 m
	+6 dB	18 m	36 m
	+12 dB	36 m	72 m
700 MHz	-6 dB	3.5 m	7 m
	0 dB	7 m	14 m
	+6 dB	14 m	28 m
	+12 dB	28 m	56 m
900 MHz	-6 dB	3 m	6 m
	0 dB	6 m	12 m
	+6 dB	12 m	24 m
	+12 dB	24 m	48 m
1800 MHz	-6 dB	2 m	4 m
	0 dB	4 m	8 m
	+6 dB	8 m	16 m
	+12 dB	16 m	32 m



Installing and mounting the antenna

i Safety instructions for installation

Observe the following safety instructions when installing the product:

- The physical mounting and all electrical installations must be performed by a specialist.
- The specialist must have sufficient professional training, experience and knowledge of applicable provisions, regulations and standards to be able to properly assess the work assigned to them, identify possible hazards and take appropriate safety measures.
- When mounting the product, observe and follow all local, national and international regulations and standards.

Observe the following instructions when installing the antenna:

- ▷ If possible, position the antennas so that there is a direct line of sight (without obstacles) between the transmitters and the antennas.
- ▷ The distance between the antenna and transmitter must be > 5 m.

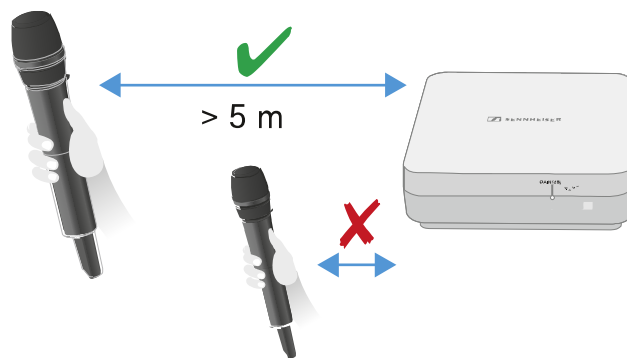

- ▷ The distance between two antennas must be > 1 m.

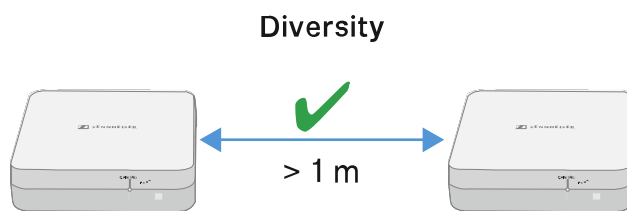

- ▷ In the case of neighboring systems with a high interference level, reduce the gain if the wanted signal is strong enough. See [Setting the gain](#).



The following mounting variants are possible:

- Mounting the antenna on the wall
- Mounting the antenna on the ceiling
- Mounting the antenna on a stand
- Mounting the antenna on a VESA mount

Mounting the antenna on the wall

- ▷ Before mounting the antenna, see the information in chapter [Installing and mounting the antenna](#).

To mount the antenna on the wall:

- i** For wall mounting, you will need the mounting frame supplied.

Screws and anchors for mounting the product to the wall are not included with delivery. Use screws and anchors that are appropriate for the particular characteristics of your wall.

- ▷ Use the included drilling template to mark the drill holes for wall mounting.
- ▷ Maintain a distance of 0.5 m to 1 m from other walls and the ceiling.
- ▷ Screw the mounting frame to the wall using four suitable screws and anchors.

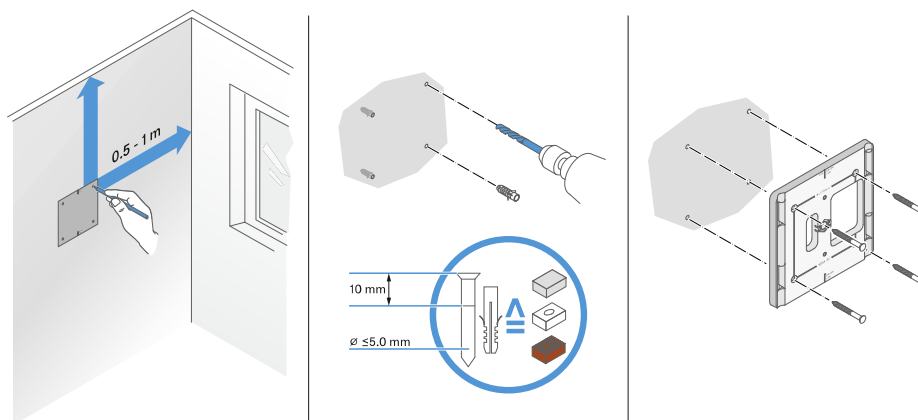

NOTICE



Damage to the product due to incorrect mounting.

Otherwise the product may fall and be damaged.

- ▷ The top marking on the mounting frame must not point downward.



- ▷ Make sure that the mounting frame is aligned correctly.

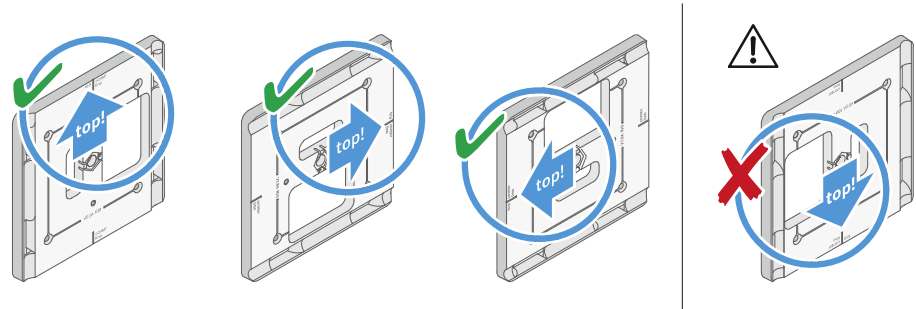

- ▷ Connect the cable to the antenna as described under [Connecting the cable to the antenna](#).
- ▷ Insert the receiver into the mounting frame as shown in the example until you hear it click into place.

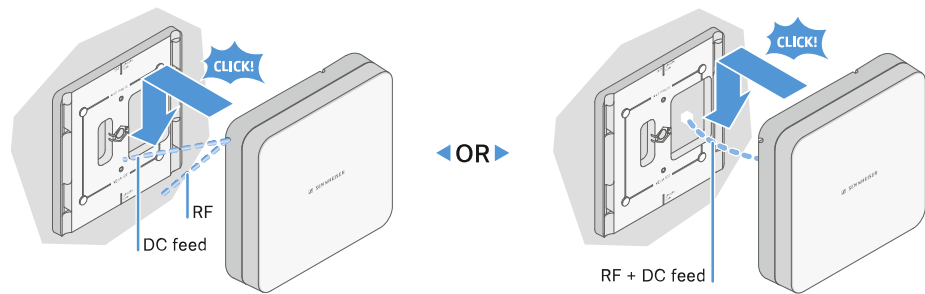

- ▷ Check that the antenna is correctly seated in the mount.



Mounting the antenna on the ceiling

- ▷ Before mounting the antenna, see the information in chapter [Installing and mounting the antenna](#).

To mount the antenna on the ceiling:

- i** For wall mounting, you will need the mounting frame supplied.

Screws and anchors for mounting the product to the wall are not included with delivery. Use screws and anchors that are appropriate for the particular characteristics of your wall.

- ▷ Use the included drilling template to mark the drill holes for ceiling mounting. The optimum placement of the antenna is in the middle of the ceiling.
- ▷ Maintain a minimum distance of 0.5 m to 1 m from the walls.
- ▷ Screw the mounting frame to the ceiling using four suitable screws and anchors.

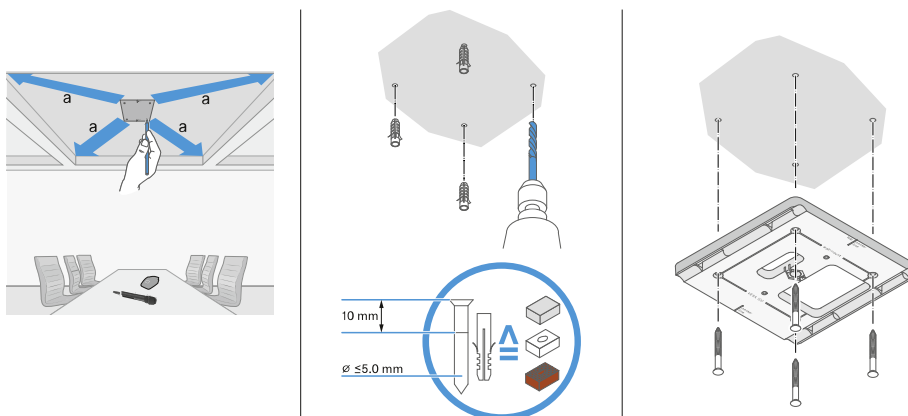

- ▷ Connect the cable to the antenna as described under [Connecting the cable to the antenna](#).



▷ Insert the receiver into the mounting frame as shown until you hear it click into place.

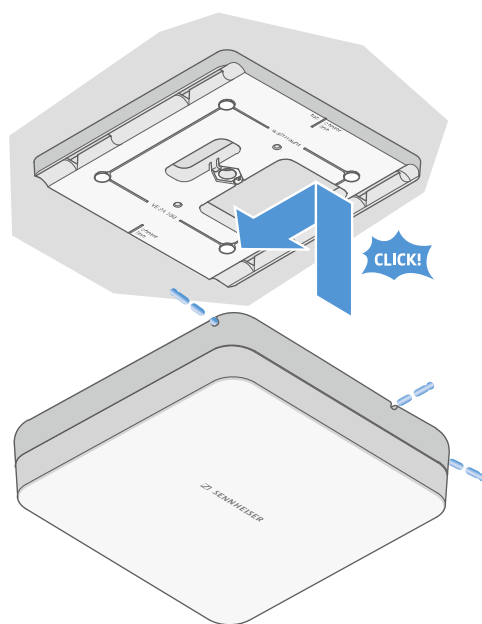

▷ Check that the antenna is correctly seated in the mount.



Mounting the antenna on a stand

- ▷ Before mounting the antenna, see the information in chapter [Installing and mounting the antenna](#).

To mount the antenna on a stand:

- i** The thread in the middle of the mounting frame is suitable for mounting on a standard microphone stand with boom arm and 3/8" thread.

⚠ CAUTION



Danger due to falling objects

If you mount the antenna improperly on the stand, the stand and receiver may tip over. This can cause personal injury and damage to property.

- ▷ Use a stand that is designed for a central load of 5 kg.
 - ▷ Adjust the length of the boom arm as short as possible, as shown in the figure.
 - ▷ Set the height of the stand to a maximum of 2 meters.
 - ▷ Make sure that the total weight of the stand and the mounted receiver does not exceed 7 kg.
-
- ▷ Screw the mounting frame onto the microphone stand as shown.
 - ▷ Insert the antenna into the mounting frame as shown until you hear it click into place.

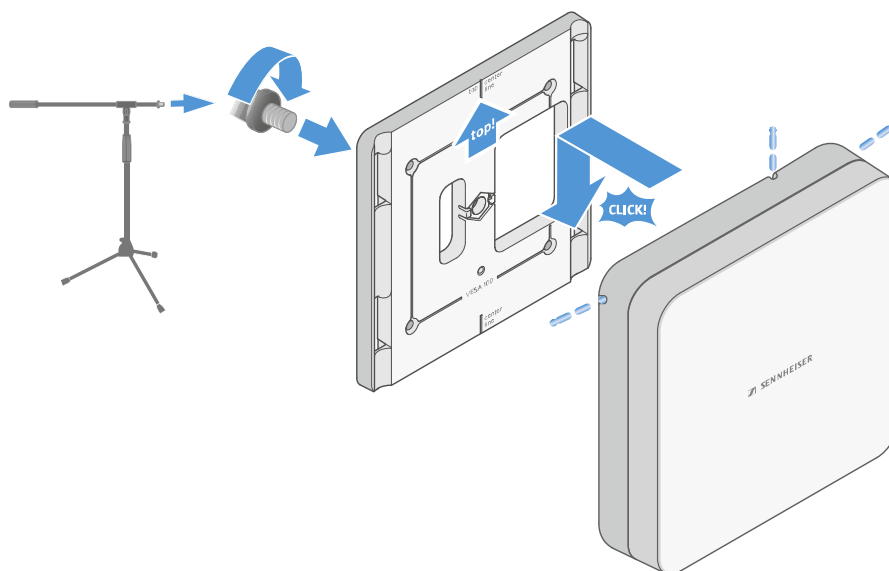



Mounting the antenna on a VESA mount

- ▷ Before mounting the antenna, see the information in chapter [Installing and mounting the antenna](#).

To mount the antenna on a VESA mount:

i The holes in the mounting frame are positioned 100 mm apart so that the mounting frame can be mounted on any VESA 100 mount.

i The antenna characteristics can be changed depending on the type of VESA mount (geometry/material).

CAUTION



Danger due to falling objects

If you mount the antenna incorrectly on the VESA mount, the VESA mount and receiver may fall down. This can cause personal injury and damage to property.

- ▷ Follow the installation and safety instructions from the manufacturer of the VESA mount.

- ▷ Screw the mounting frame onto the VESA mount as shown using four suitable screws (not supplied).
- ▷ Insert the antenna into the mounting frame as shown until you hear it click into place.

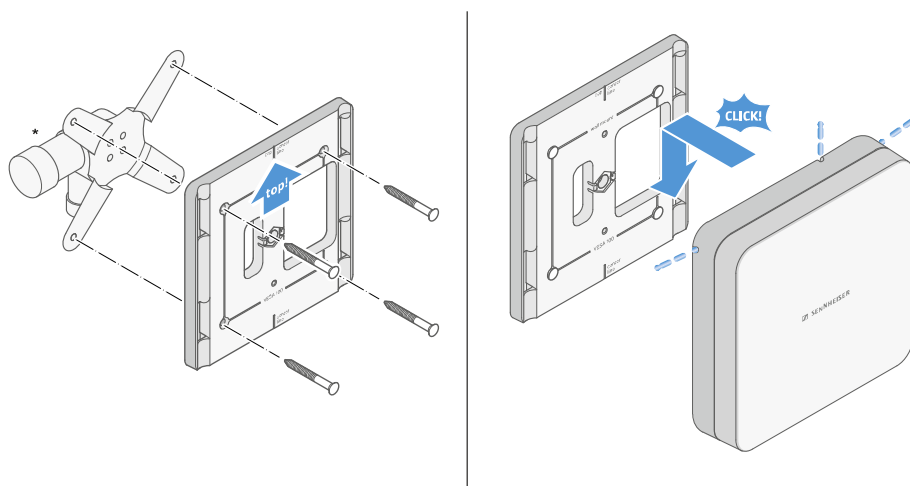

*Example image of a VESA 100 mount



Setting the gain

To set the desired gain:

- ▷ Slide the switch to the desired position.

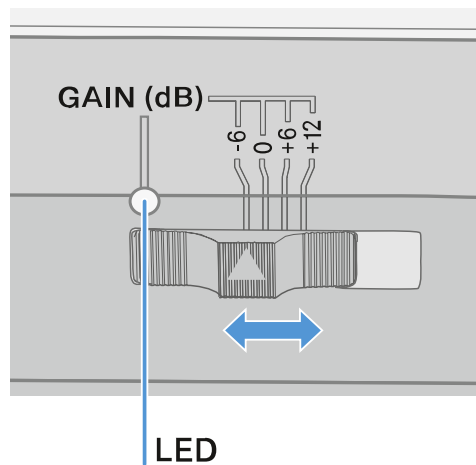

- ➔ The LED lights up in the appropriate color.

i For information about the GAIN LED, see [GAIN LED](#)



GAIN LED

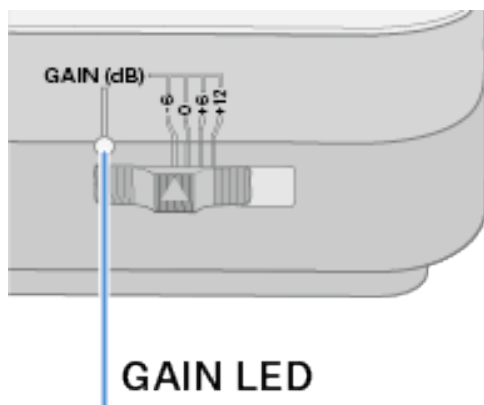

The **GAIN** LED on the front of the antenna can indicate the following information.

The LED is white:

Gain set to +12 dB.



The LED is blue:

Gain set to +6 dB.



The LED is green:

Gain set to 0 dB.



The LED is orange:

Gain set to -6 dB.



The LED is off:

no or insufficient power supply.





Cleaning and maintenance

Note the following information when cleaning and maintaining products of the Evolution Wireless Digital series.

NOTICE



Liquids can damage the products' electronics.

Liquids entering the product housing can cause a short-circuit and damage the electronics.

- ▷ Keep all liquids away from the products.
- ▷ Do not use any solvents or cleansing agents.

- ▷ Disconnect the products from the power supply system and remove rechargeable batteries and batteries before you begin cleaning.
- ▷ Clean all products only with a soft, dry cloth.
- ▷ Note the special cleaning instructions below for the following products.

Cleaning the sound inlet basket of the microphone module

- ▷ Unscrew the top sound inlet basket from the microphone module by turning it counterclockwise.
- ▷ Remove the foam insert.



- i** You can clean the sound inlet basket in two ways:
- Use a slightly damp cloth to clean the top sound inlet basket from the inside and outside.
 - Use a brush and rinse with clean water.

- ▷ If necessary, clean the foam insert with a mild detergent or replace the foam insert.
- ▷ Dry the top sound inlet basket and foam insert.
- ▷ Reinsert the foam insert.
- ▷ Screw the sound inlet basket back onto the microphone module.



From time to time, you should also clean the microphone module contacts:

- ▷ Wipe the contacts of the microphone module with a soft, dry cloth.

Cleaning the transmitter's contacts

- ▷ Wipe the contacts with a dry cloth.

Cleaning the L 70 USB and CHG 70N chargers

- ▷ Remove all rechargeable batteries from the charging slots.
- ▷ Disconnect the charger from the power supply system before cleaning.
- ▷ Clean the product with a dry cloth.
- ▷ In addition, use a brush to remove dust from the charging slots.
- ▷ Clean the charging contacts from time to time with a cotton swab, for instance.



4. Frequently asked questions

This section contains answers to frequently asked questions and further information.

- [Radio and frequencies](#)
- [Audio](#)
- [Usability](#)
- [Accessories](#)
- [Smart Assist app](#)

Radio and frequencies

This section contains answers to frequently asked questions and further information about the following topics:

Why won't my transmitter synchronize with my receiver?

- Briefly press the **SYNC** button on both devices, but don't press too long ([Establishing a radio link | Synchronizing the receiver and transmitter](#))
- The two devices must have the same frequency range ([Frequency ranges](#))

What is the transmission range of the transmitter?

- Up to 100 m in an ideal environment (without obstacles)

What is the best way to wear the bodypack transmitter?

- Do not kink, bend or cover the antenna
- Avoid skin contact with the antenna
- If possible, attach it to your clothing with the belt clip



How do I know which transmitter is coupled to which receiver?

- EW-D SKM-S: [Identifying the paired receiver \(Identify function\)](#)
- EW-D SK: [Identifying the paired receiver \(Identify function\)](#)
- EW-DX SKM(-S): [Identifying the paired receiver \(Identify function\)](#)
- EW-DX SK (3-PIN): [Identifying the paired receiver \(Identify function\)](#)
- Additional option: Use color coding: [Using EW-D Color Coding Sets to label transmission paths](#)

How can I distinguish between my wireless links without displays on the transmitters?

- EW-DX SKM(-S): [Identifying the paired receiver \(Identify function\)](#)
- EW-DX SK (3-PIN): [Identifying the paired receiver \(Identify function\)](#)
- Additional option: Use color coding: [Using EW-D Color Coding Sets to label transmission paths](#)

The transmitter and receiver are synchronized, but there is no connection.

- Install antennas correctly on the receiver (EW-D EM: [Connecting antennas](#) | EW-DX EM 2: [Connecting antennas](#))
- EW-D: Use the scan function to find a free channel [AUTO SCAN menu item](#) and synchronize the transmitter again [Establishing a radio link | Synchronizing the receiver and transmitter](#)
- EW-DX: Using the Auto Setup function, find a free channel [Ch 1 / Ch 2 -> Scan / Auto Setup menu item](#) and resynchronize the transmitter [Establishing a radio link | Synchronizing the receiver and transmitter](#)

The display on the receiver shows signal levels even though the paired transmitter is not switched on.

- There may be interfering frequencies (e.g. TV channels)
- EW-D: Use the scan function to find a free channel [AUTO SCAN menu item](#) and synchronize the transmitter again [Establishing a radio link | Synchronizing the receiver and transmitter](#)
- EW-DX: Using the Auto Setup function, find a free channel [Ch 1 / Ch 2 -> Scan / Auto Setup menu item](#) and resynchronize the transmitter [Establishing a radio link | Synchronizing the receiver and transmitter](#)



Which frequency ranges are available?

- [Frequency ranges](#)



Audio

Which microphones can I use with my bodypack transmitter?

- EW-D SK: [Connecting a microphone to the bodypack transmitter](#)
- EW-DX SK (3-PIN): [Connecting a microphone to the bodypack transmitter](#)

Which microphone modules can I use with my handheld transmitter?

- EW-D SKM-S: [Replacing the microphone module](#)
- EW-DX SKM(-S): [Replacing the microphone module](#)

What exactly do the “Gain” and “AF Out” settings do?

- Gain: Level of the audio signal coming from the transmitter (EW-D EM: [GAIN menu item](#) | EW-DX EM 2 [Ch 1 / Ch 2 -> Gain menu item](#))
- AF Out: Level of the audio signal coming from the receiver (EW-D EM: [AF OUT menu item](#) | EW-DX EM 2 [Ch 1 / Ch 2 -> AF Out menu item](#))

How do I adjust the settings so that my wireless link has the same volume as my guitar cable?

- EW-D: Configure **unity gain** settings under the menu items **GAIN** (volume that reaches the receiver from the guitar through the bodypack transmitter – [GAIN menu item](#)) and **AF OUT** (volume output from the receiver to the guitar amplifier – [AF OUT menu item](#)).

Possible **unity gain** settings (depending on the level of the incoming signal):

- AF Out **18 dB** | Gain **27 dB**
- AF Out **12 dB** | Gain **33 dB**
- AF Out **6 dB** | Gain **39 dB**



How can I adjust sensitivity on the transmitter?

- EW-D: You cannot make any settings on the transmitter. You can adjust the level of the signal coming from the transmitter under the **GAIN** menu item ([GAIN menu item](#)) on the receiver.
- EW-DX: In addition to the gain that is set in the receiver ([Ch 1 / Ch 2 -> Gain menu item](#)), you can also set the trim on the transmitter (EW-DX SKM(-S): [Trim menu item](#) | EW-DX SK (3-PIN): [Trim menu item](#)) to adjust the sensitivity to the incoming audio signal.

What is the latency?

- 1.9 ms

Which audio outputs are available on the receiver?

- XLR-3 and 6.3 mm jack (EW-D EM: [Outputting audio signals](#) | EW-DX EM 2: [Outputting audio signals](#))



Usability

This section contains answers to frequently asked questions and further information about the following topics:

Why won't my transmitter synchronize with my receiver?

- Briefly press the SYNC button on both devices, but don't press too long ([Establishing a radio link | Synchronizing the receiver and transmitter](#))
- The two devices must have the same frequency range [Frequency ranges](#)

Is there a way to check the battery status of the transmitter other than on the receiver?

- The Check function allows you to check the battery status on the transmitter.
- EW-D SKM-S: [Checking the battery status of the transmitter \(Check function\)](#)
- EW-D SK: [Checking the battery status of the transmitter \(Check function\)](#)

How do I know if my transmitter is switched on?

- The transmitter's **LINK LED** lights up.
- EW-D SKM-S: [Meaning of the LEDs](#)
- EW-D SK: [Meaning of the LEDs](#)
- EW-DX SKM(-S): [Meaning of the LEDs](#)
- EW-DX SK (3-PIN): [Meaning of the LEDs](#)

My LINK LED is steady or flashing yellow. What does that mean?

- EW-D EM: [Meaning of the LEDs](#)
- EW-D SKM-S: [Meaning of the LEDs](#)
- EW-D SK: [Meaning of the LEDs](#)
- EW-DX EM 2: [Meaning of the LEDs](#)
- EW-DX SKM(-S): [Meaning of the LEDs](#)
- EW-DX SK (3-PIN): [Meaning of the LEDs](#)



My LINK LED is steady or flashing red. What does that mean?

- EW-D EM: [Meaning of the LEDs](#)
- EW-D SKM-S: [Meaning of the LEDs](#)
- EW-D SK: [Meaning of the LEDs](#)
- EW-DX EM 2: [Meaning of the LEDs](#)
- EW-DX SKM(-S): [Meaning of the LEDs](#)
- EW-DX SK (3-PIN): [Meaning of the LEDs](#)

Can I also operate an EW-D with desktop applications such as WSM or Control Cockpit?

- No, that is not possible.

Can I also operate an EW-DX with desktop applications such as WSM or Control Cockpit?

- Yes, the EW-DX can be operated with WSM and the Control Cockpit ([Connecting receivers in a network](#)).

Is the Smart Assist app necessary to operate my devices?

- No, every device can also be operated without the Smart Assist app. However, the app offers certain advantages (see [Smart Assist app](#)).

Can the transmitter and receiver connect to other Bluetooth-capable systems?

- A Bluetooth connection can only be established between a receiver and a smartphone with the Smart Assist app installed.

How can I turn on my transmitter without it transmitting immediately?

- Press and hold the **SYNC** button and then short-press the **ON/OFF** button (EW-D SKM-S: [Product overview](#) / EW-D SK: [Product overview](#)).



Can the ew G4 and EW-D series be operated together?

- The products in the **ew G4** and **EW-D** series are not compatible with each other. However, you can operate the two series in parallel without any problems.

Are the receivers and transmitters of the EW-D and EW-DX series compatible?

- [Information on compatibility between EW-D, EW-DX and EW-DP](#)

How can I distinguish between my wireless links without displays on the transmitters?

- EW-D SKM-S: [Identifying the paired receiver \(Identify function\)](#)
- EW-D SK: [Identifying the paired receiver \(Identify function\)](#)
- Additional option: Use color coding ([Using EW-D Color Coding Sets to label transmission paths](#))

What exactly do the “Gain” and “AF Out” settings do?

- Gain: Level of the audio signal coming from the transmitter (EW-D EM: [GAIN menu item](#) | EW-DX EM 2: [Ch 1 / Ch 2 -> Gain menu item](#))
- AF Out: Level of the audio signal coming from the receiver (EW-D EM: [AF OUT menu item](#) | EW-DX EM 2: [Ch 1 / Ch 2 -> AF Out menu item](#))

What is the meaning of the Bluetooth icon on the receiver’s display?

- The receiver is paired to a smartphone, so you can make settings via the Smart Assist app.
- [Displays on the receiver’s display panel](#)
- [Smart Assist app](#)

I don’t want a smartphone to have access to my receiver.

- Disconnect the Bluetooth pairing in your smartphone’s menu.



What is the best way to wear the bodypack transmitter?

- Do not kink, bend or cover the antenna
- Avoid skin contact with the antenna
- If possible, attach it to your clothing with the belt clip

Can you rotate the bodypack transmitter's belt clip so that the antenna points downward?

- Yes, see [Changing the belt clip](#)



Accessories

Which microphones can I use with my bodypack transmitter?

- EW-D SK: [Connecting a microphone to the bodypack transmitter](#)
- EW-DX SK (3-PIN): [Connecting a microphone to the bodypack transmitter](#)

Which microphone modules can I use with my handheld transmitter?

- EW-D SKM-S: [Replacing the microphone module](#)
- EW-DX SKM(-S): [Replacing the microphone module](#)

Which batteries can I use for my transmitter?

- 2x AA 1.5 V **or**
- Sennheiser BA 70 rechargeable battery: [BA 70 rechargeable battery and L 70 USB charger](#)
- EW-D SKM-S: [Inserting and removing the batteries/rechargeable batteries](#)
- EW-D SK: [Inserting and removing the batteries/rechargeable batteries](#)
- EW-DX SKM(-S): [Inserting and removing the batteries/rechargeable batteries](#)
- EW-DX SK (3-PIN): [Inserting and removing the batteries/rechargeable batteries](#)

Can I use accessories that I already have from other microphone series?

- You can use passive devices without a power supply (e.g. AD 1800 or A 1031-U antennas).
- You may already have compatible microphones or microphone modules:
 - EW-D SK: [Connecting a microphone to the bodypack transmitter](#)
 - EW-DX SK (3-PIN): [Connecting a microphone to the bodypack transmitter](#)
 - EW-D SKM-S: [Replacing the microphone module](#)
 - EW-DX SKM(-S): [Replacing the microphone module](#)
- We always recommend using the accessories that are optimized for the EW-D: [Accessories](#)



Which antennas can I use with my receiver?

- In principle, you can use all antennas with BNC connectors that cover the frequency ranges of the EW-D series ([Frequency ranges](#))
- Recommended: [Antennas](#)

What are the advantages of the Half Wave Dipole rod antennas (available as accessories) compared to the shorter rod antennas included with delivery?

- The **Half Wave Dipole** rod antennas have a higher antenna gain and therefore provide greater transmission range in low-scatter and low-reflection environments ([Rod antennas](#)).

My set is missing the power supply unit and the rack mounting bracket.

- Take out the packaging insert:

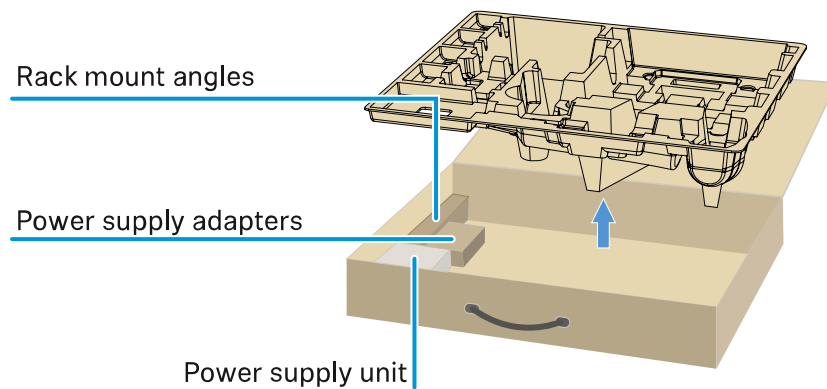



Smart Assist app

Is the Smart Assist app necessary to operate my devices?

- No, every device can also be operated without the Smart Assist app. However, the app offers certain advantages (see [Smart Assist app](#)).

I want to see if the app is right for me before registering. Where can I get more information?

- In the app's demo mode or on the website: <https://www.sennheiser.com/evolution-wireless-digital-app>

In which languages is the app available?

- English
- German
- French
- Spanish
- Portuguese
- Russian
- Chinese
- Korean
- Arabic

Can I pair multiple smartphones with a single receiver?

- No, you can pair only one smartphone with the receiver.

How many devices can I operate with my app?

- Up to 16 channels

How do I create a setup with 2 or more devices?

- Use the **Add Device** and **Auto Scan** functions. The app will lead you step by step through the process.



Can I set a specific frequency range for the Auto Scan function?

- No, the function scans the entire available frequency spectrum.

Why can't I access a receiver?

- The receiver may be switched off or out of Bluetooth range.

How are the app and the receivers connected to the app secured against possible misuse?

- To pair a receiver and a smartphone, both devices must be physically present.
Only after successful pairing can values in the receiver be changed via the smartphone.

Can I use a Bluetooth dongle to operate the app on a computer?

- No. The app is only available for iOS and Android.

How can I display the app on a larger screen?

- You can use a mirroring service such as QuickTime. However, you still control the app from the smartphone.



5. Specifications

All specifications at a glance.

System

EW-D EM rack receiver
EW-DX EM 2 rack receiver
EW-DX EM 2 Dante rack receiver
EW-DX EM 4 Dante rack receiver
EW-D SKM-S handheld transmitter
EW-DX SKM | EW-DX SKM-S handheld transmitter
EW-D SK bodypack transmitter
EW-DX SK | EW-DX SK 3-PIN bodypack transmitter
Table stand EW-DX TS 3-pin | EW-DX TS 5-pin
EW-DP EK portable receiver
EW-DP SKP plug-on transmitter receiver
EW-D ASA antenna splitter
EW-D AB antenna booster
AWM active directional antenna
ADP UHF passive directional antenna (470 – 1075 MHz)
BA 70 rechargeable battery
L 70 USB charger
CHG 70N-C charger

System

Audio link frequency ranges for EW-D, EW-DP

- **Q1-6:** 470.2 – 526 MHz
- **R1-6:** 520 – 576 MHz
- **R4-9:** 552 – 607.8 MHz
- **S1-7:** 606.2 – 662 MHz
- **S4-7:** 630 – 662 MHz
- **S7-10:** 662 – 693.8 MHz
- **U1/5:** 823.2 – 831.8 MHz & 863.2 – 864.8 MHz
- **V3-4:** 925.2 – 937.3 MHz
- **Y1-3:** 1785.2 – 1799.8 MHz



Audio-Link EW-DX frequency ranges

- **Q1-9:** 470.2 – 550 MHz
- **R1-9:** 520 – 607.8 MHz
- **S1-10:** 606.2 – 693.8 MHz
- **S2-10:** 614.2 – 693.8 MHz
- **S4-10:** 630 – 693.8 MHz
- **U1/5:** 823.2 – 831.8 MHz & 863.2 – 864.8 MHz
- **V3-4:** 925.2 – 937.3 MHz
- **V5-7:** 941.7 – 951.8 MHz & 953.05 – 956.05 MHz & 956.65 – 959.65 MHz
- **Y1-3:** 1785.2 – 1799.8 MHz

Bluetooth® Low Energy (BLE) frequency range

2402 – 2480 MHz

Audio frequency response

20 Hz – 20 kHz (-3 dB) @ 3 dBfs

Audio THD

≤ -60 dB for 1 kHz @ -3 dBfs input level

Dynamic range

134 dB

System latency

1.9 ms

Operating temperature range

-10 °C – +55 °C (EW-D, EW-DP)

Relative humidity

5 – 95 % (non-condensing)



EW-D EM rack receiver

Input voltage

DC 11 – 13 V

Input current

≤ 300 mA

Transmission power

BLE: max. 10 mW EIRP

Audio output power

18 dBu max.

Dimensions

212 × 44 × 189 mm (1 3/4" × 3 7/8" × 7 3/16")

Weight

Approx. 1000 g (without antennas and power supply unit)



EW-DX EM 2 rack receiver

Input voltage

DC 11 – 13 V or PoE IEEE 802.3af Class 0 (CAT5e or higher)

Input current

≤ 1 A

Transmission power

BLE: max. 10 mW EIRP

Audio output power

18 dBu max.

Headphone output

2x 70 mW @ 32 Ω

Ethernet

RJ-45 socket, IEEE802.3

100Base-TX (half+full duplex)

10Base-T (half+full duplex)

(CAT5e or higher)

Dimensions

212 × 44 × 206 mm (1 3/4" x 3 7/8" x 7 3/16")

Weight

Approx. 1000 g (without antennas and power supply unit)



EW-DX EM 2 Dante rack receiver

Input voltage

11 to 13 V DC or PoE IEEE 802.3af Class 0 (shielded CAT5e or higher, S/FTP or S/STP)

Input current

≤ 1 A at 12 V DC

Power consumption

Max. 12 W

Transmission power

BLE: max. 10 mW EIRP

Audio output power

18 dBu max.

Headphone output

2x 70 mW @ 32 Ω

Ethernet

3x RJ-45 sockets, IEEE802.3

1000Base-T (full duplex)

100Base-TX (half+full duplex)

10Base-T (half+full duplex) for network control

(shielded CAT5e or higher, S/FTP or S/STP)

Dimensions

212 × 44 × 169 mm (1 3/4" x 3 7/8" x 7 3/16")

Weight

Approx. 1000 g (without antennas and power supply unit)



EW-DX EM 4 Dante rack receiver

Input voltage

90 to 265 V AC, 47 to 63 Hz

Power consumption

Max. 37 W

Transmission power

BLE: max. 10 mW EIRP

Audio output power

18 dBu max.

Headphone output

2x 70 mW @ 32 Ω

Ethernet

Dante® digital audio output, RJ-45; 48 kHz, 96 kHz, 24 bit

Daisy chain output 2x BNC (50 Ω); 0 dB +/- 0.5 dB amplification relative to antenna inputs

Cascaded receiver (RF), max. 4 EW-DX EM 4 Dante

Dimensions

483 × 44 × 373 mm (1 3/4" × 3 7/8" × 7 3/16")

Weight

Approx. 4560 g (without antennas and power supply unit)



EW-D SKM-S handheld transmitter

Input voltage

2.0 – 4.35 V

Input current

< 300 mA

Power supply

2 AA batteries 1.5 V (alkali manganese) or BA 70 rechargeable battery pack

Bandwidth

200 kHz

Transmission power

- Audio link: 10 mW ERP (Range Y1-3: 12 mW ERP)
- BLE: max. 10 mW EIRP

Dimensions (diameter x length)

50 x 268 mm (incl. MMD 835 microphone module)

Weight (without batteries)

- Approx. 304 g (incl. MMD 835 microphone module)
- Approx. 195 g (without microphone module)



EW-DX SKM | EW-DX SKM-S handheld transmitter

Input voltage

2.0 – 4.35 V

Input current

< 300 mA

Power supply

2 AA batteries 1.5 V (alkali manganese) or BA 70 rechargeable battery pack

Bandwidth

200 kHz

Transmission power

- Audio link: 10 mW ERP (Range Y1-3: 12 mW ERP)
- LD mode: 10 mW ERP
- BLE: max. 10 mW EIRP

Dimensions (diameter x length)

- 50 x 268 mm (incl. MMD 835 microphone module)
- 40 x 200 mm (without microphone module)

Weight (without batteries)

- Approx. 304 g (incl. MMD 835 microphone module)
- Approx. 195 g (without microphone module)



EW-D SK bodypack transmitter

Input voltage

2.0 – 4.35 V

Input current

< 300 mA

Power supply

2 AA batteries 1.5 V (alkali manganese) or BA 70 rechargeable battery pack

Bandwidth

200 kHz

Transmission power

- Audio link: 10 mW ERP (Range Y1-3: 12 mW ERP)
- BLE: max. 10 mW EIRP

Dimensions (diameter x length)

63 x 80 x 20 mm (without antennas)

Weight (without batteries)

Approx. 120 g



EW-DX SK | EW-DX SK 3-PIN bodypack transmitter

Input voltage

2.0 – 4.35 V

Input current

< 300 mA

Power supply

2 AA batteries 1.5 V (alkali manganese) or BA 70 rechargeable battery pack

Bandwidth

200 kHz

Transmission power

- Audio link: 10 mW ERP (Range Y1-3: 12 mW ERP)
- LD mode: 10 mW ERP
- BLE: max. 10 mW EIRP

Dimensions (diameter x length)

63 x 80 x 20 mm (without antennas)

Weight (without batteries)

approx. 115 – 120 g



Table stand EW-DX TS 3-pin | EW-DX TS 5-pin

Input voltage

2.0 to 4.35 V

Input current

< 300 mA

Power supply

Sennheiser BA 40

Bandwidth

200 kHz

Transmission power

Audio link: 10 mW ERP (Range Y1-3: 12 mW ERP)

LD mode: 10 mW ERP

Bluetooth Low Energy: max. 10 mW EIRP

Dimensions

166.7 × 120.2 × 48.1 mm (1 3/4" × 3 7/8" × 7 3/16")

Weight

Approx. 650 g (excl. rechargeable battery)



EW-DP EK portable receiver

Input voltage

~ 1.8 – 4.35 V

Input current

Typically < 250 mA / max. < 400 mA / max. < 750 mA

(2x AA batteries) < 300 mA @ 5 V (USB-C standalone)

Power supply

2x AA batteries 1.5 V or USB-C PD (max.):

- 5 V/1500 mA
- 9 V/900 mA
- 12 V/700 mA

Transmission power

BLE: max. 10 mW EIRP

Audio output power

< 2 dBV max. (high level) /

< 4 dBV max. (high level)

Headphone output

< 50 mW into 16 ohms

Dimensions

86 × 67 × 28 mm (1 3/4" × 3 7/8" × 7 3/16")

Weight

Approx. 140 g



EW-DP SKP plug-on transmitter receiver

Input voltage

~ 2.0 – 4.35 V

Input current

Typically < 300 mA (without current draw and P48)

Power supply

2x AA batteries (1.5 V) or BA 70 rechargeable battery

Transmission power

Audio link: 10 mW ERP

BLE: max. 10 mW EIRP

Audio output power

< 2 dBV max. (high level) /

< 4 dBV max. (high level)

Headphone output

108 x 42 mm

Dimensions

86 × 67 × 28 mm (1 3/4" x 3 7/8" x 7 3/16")

Weight

Approx. 163 g



EW-D ASA antenna splitter

Frequency ranges

- **EW-D ASA (Q-R-S):** 470 – 694 MHz
- **EW-D ASA CN/ANZ(Q-R-S):** 470 – 694 MHz
- **EW-D ASA (T-U-V-W):** 694 – 1075 MHz
- **EW-D ASA (X-Y):** 1350 – 1805 MHz

EW-D ASA antenna splitter

2 x 1:4 or 1 x 1:8, active

Gain

- in A – out A: 0 ± 1 dB
- in A – out A1 ... A4: 0 ± 1 dB
- in B – out B1 ... B4: 0 ± 1 dB

IIP3

> 25 dBm

Impedance

50 Ω

Reflection loss

10 dB (all RF outputs)

Operating voltage

DC +12 V from NT 12-35 CS power supply unit

Current consumption

210 mA

Total current consumption

Max. 3 A (with 4 EW-D EM and connected EW-D AB)

Supply for antenna boosters at ANT RF in A and ANT RF in B

- DC 12 V
- 320 mA



Supply for receivers at A1 to A4

- DC 12 V
- Typically 350 mA, max. 500 mA

Relative humidity

5 – 95 %

Operating temperature range

-10 °C – +55 °C (14 °F – 131 °F)

Storage temperature range

-20 °C – +70 °C (-4 °F – 158 °F)

Dimensions

Approx. 212 x 168 x 43 mm

Weight

Approx. 1100 g



Block diagram

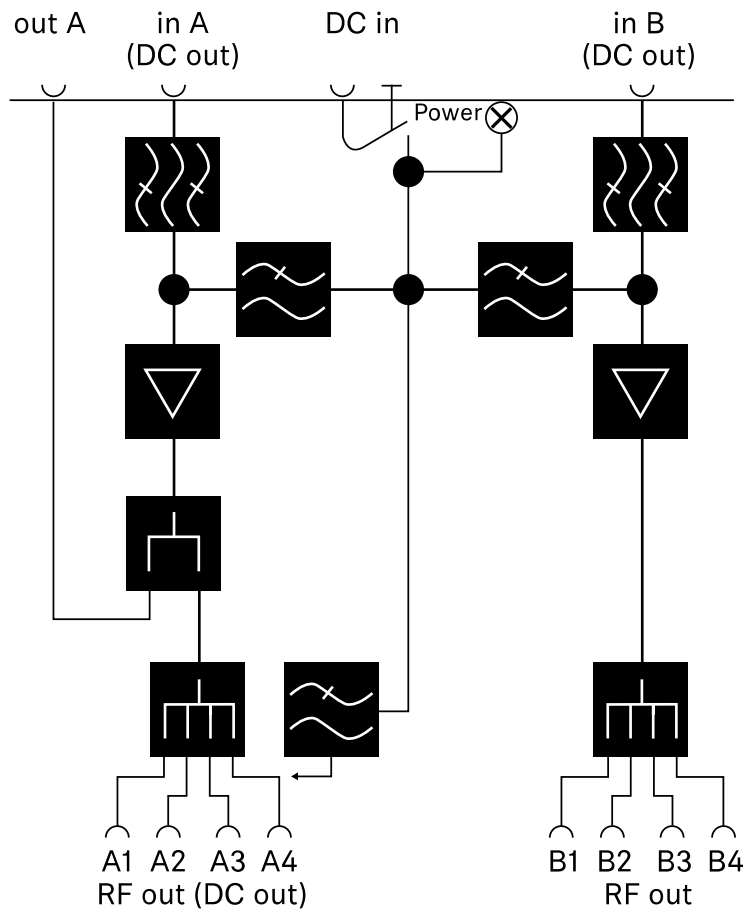



EW-D AB antenna booster

Frequency ranges

- **EW-D AB (Q):** 470 – 550 MHz
- **EW-D AB (R):** 520 – 608 MHz
- **EW-D AB (S):** 606 – 694 MHz
- **EW-D AB (U):** 823 – 865 MHz
- **EW-D AB (V):** 902 – 960 MHz
- **EW-D AB (Y):** 1785 – 1805 MHz

Power supply (DC coupled)

DC 12 V (DC 9 – 18 V) / max. 160 mA @ 12 V, center contact +

IIP3

> 25 dBm

Max. RF input power

+10 dBm

Gain

Typically 12 dB

Impedance

50 Ω

Connections

2x BNC female, DC power supply from OUT to ANT

Dimensions

Approx. 95 x 47 x 21 mm

Weight

Approx. 120 g

Relative humidity

5 – 95 %

Operating temperature range

-10 °C – +55 °C (14 °F – 131 °F)

Storage temperature range

-20 °C – +70 °C (-4 °F – 158 °F)



AWM active directional antenna

Frequency ranges

- UHF I: 470 – 694 MHz
- UHF II: 823 – 1075 MHz
- 1 G8: 1785 – 1805 MHz

Apex angle (horizontal, -3 dB)

- UHF I: not applicable
- UHF II: approx. 80°
- 1 G8: approx. 110°

Front-to-back ratio

- UHF I: not applicable
- UHF II: approx. 10 dB
- 1 G8: approx. 10 dB

Antenna gain

- UHF I: $\geq +3.0$ dBi (480 MHz) | $\geq +3.5$ dBi (582 MHz) | $\geq +4.5$ dBi (694 MHz)
- UHF II: $\geq +6.0$ dBi
- 1 G8: $\geq +6.0$ dBi

Antenna polarization

Linear

Amplification (signal booster, low-noise, band-selective, +/-1 dB)

- +12 dB: Max. amplification 12 dB
- +6 dB: Max. amplification 6 dB
- 0 dB¹: Max. amplification UHF I, UHF II: -0.5; 1 G8: -1.5
- -6 dB: Max. amplification -6 dB

¹ The band-selective booster is bypassed at 0 dB. This mode requires a DC power supply.

OIP3 (@ “+12 dB”)

≥ 35 dBm

Max. RF output power

- UHF I / UHF II: approx. +22 dBm
- 1 G8: approx. +18 dBm



RF connection

BNC female, DC coupled

Impedance

50 Ω

DC connection

5.5 x 1.6 mm DC hollow jack, polarity: + inside

Power supply (via BNC or DC)

12 V DC (9 – 18 V DC) / max. 100 mA @ 12 V

LED display

ON (white = "+12 dB"; blue = "+6 dB"; green = "0 dB"; orange = "-6 dB")

OFF (no or insufficient power supply)

Thread for tripod mounting

3/8" inside thread

Mounting holes

VESA 100 x 100

Color

Traffic white (RAL: 9016)

Housing material

Halogen-free flame-retardant PC/ABS

Dimensions

- Without wall bracket: 180 x 180 x 53 mm
- With wall bracket: 180 x 180 x 63 mm

Weight

Approx. 700 g

Operating temperature range

-10 °C to +55 °C

Storage temperature range

-20 °C to +70 °C

Relative humidity



5 to 95%

Polar diagram

Normalized to max. antenna gain

UHF (470 – 694 MHz) vertical [dB]

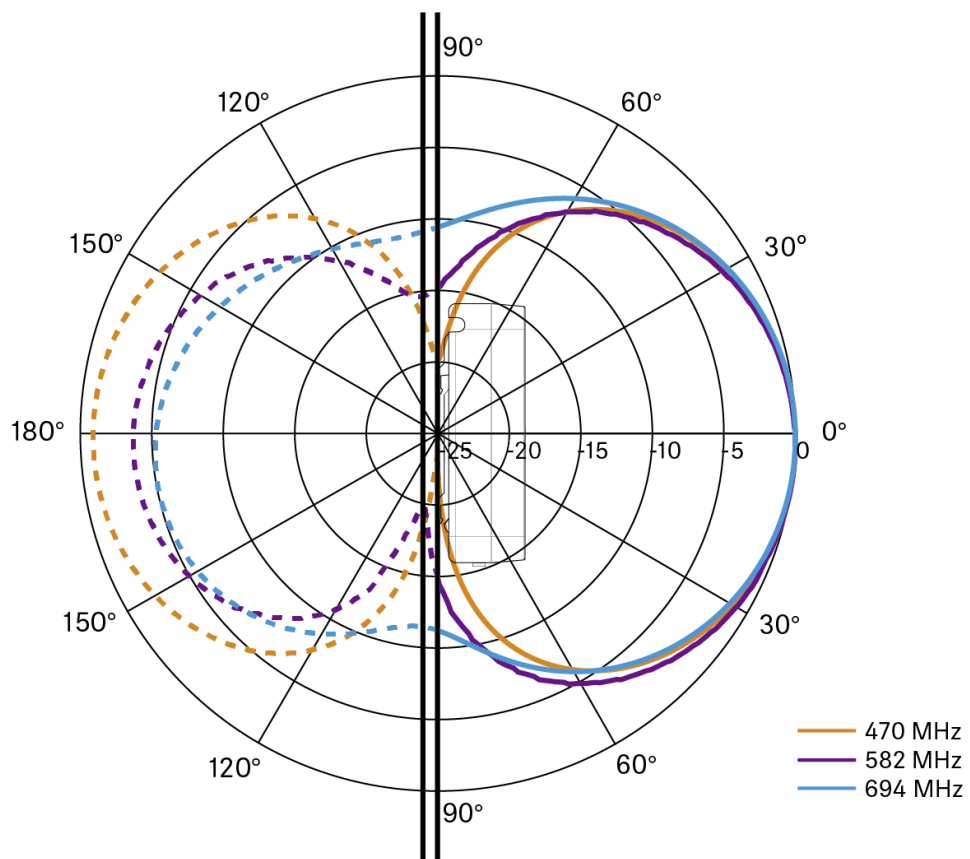



UHF (470 – 694 MHz) horizontal [dB]

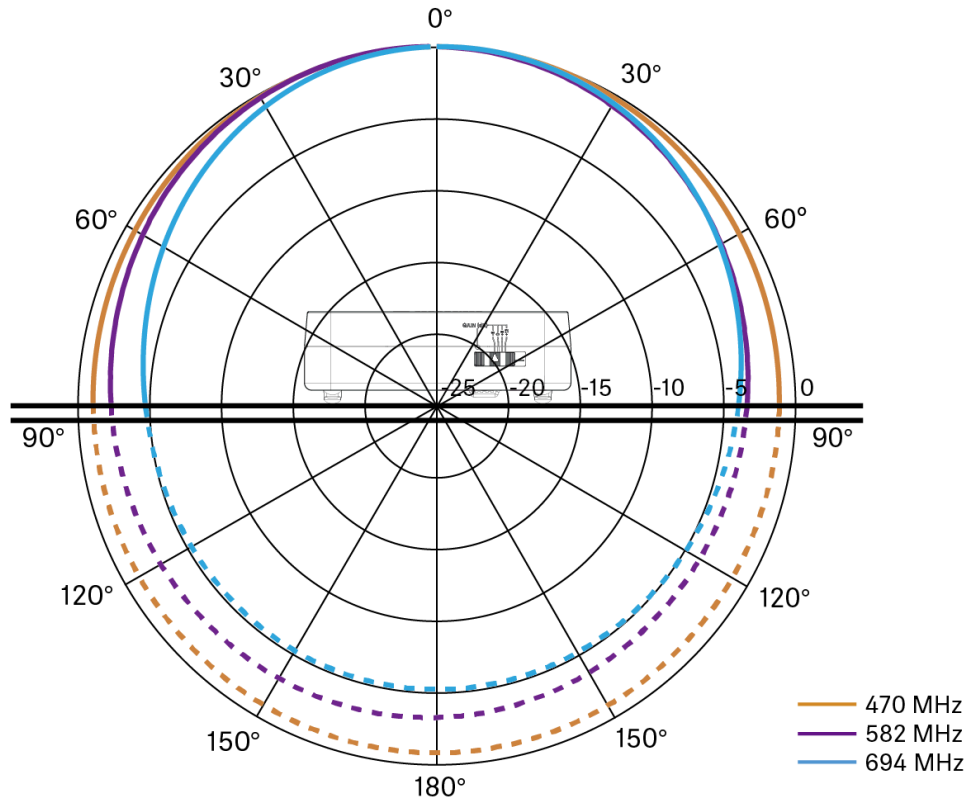

UHF (823 – 1075 MHz) vertical [dB]

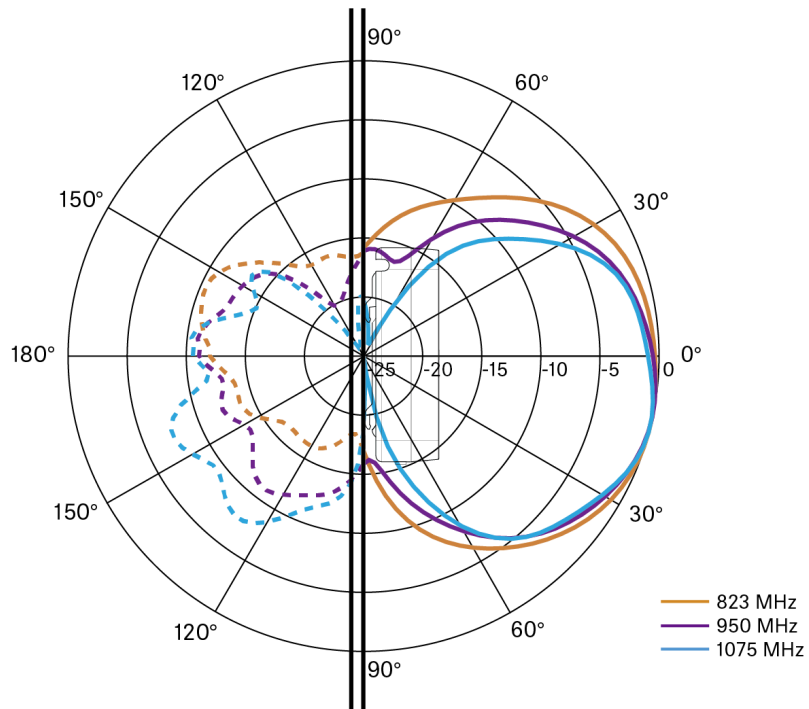



UHF (823 – 1075 MHz) horizontal [dB]

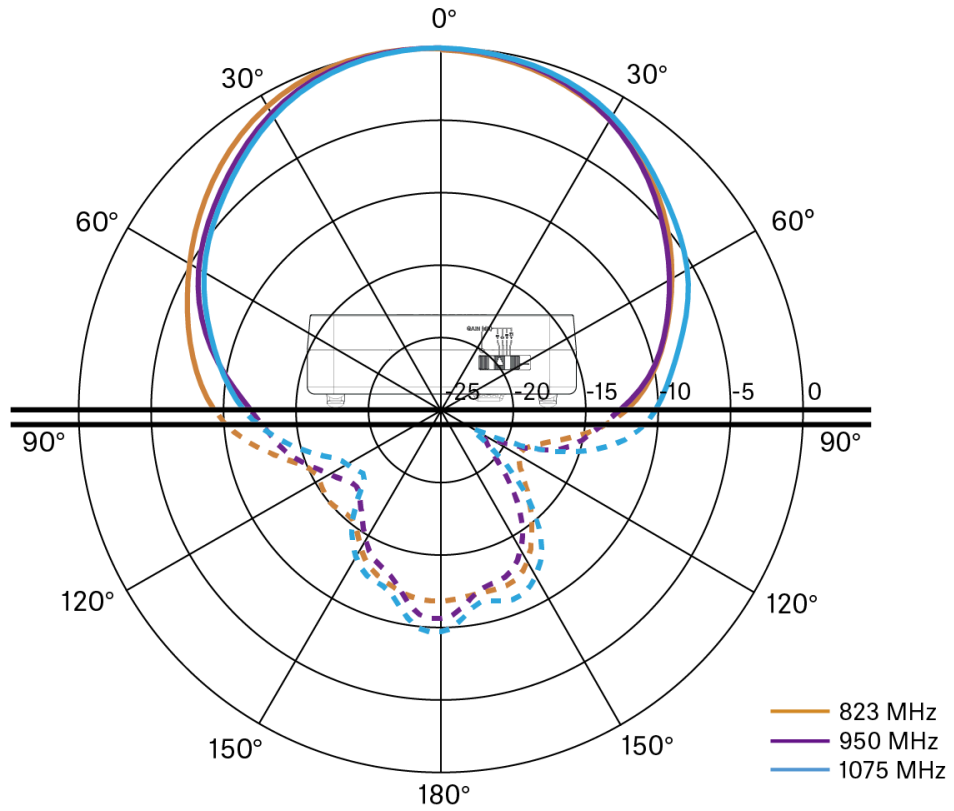



1G8 vertical [dB]

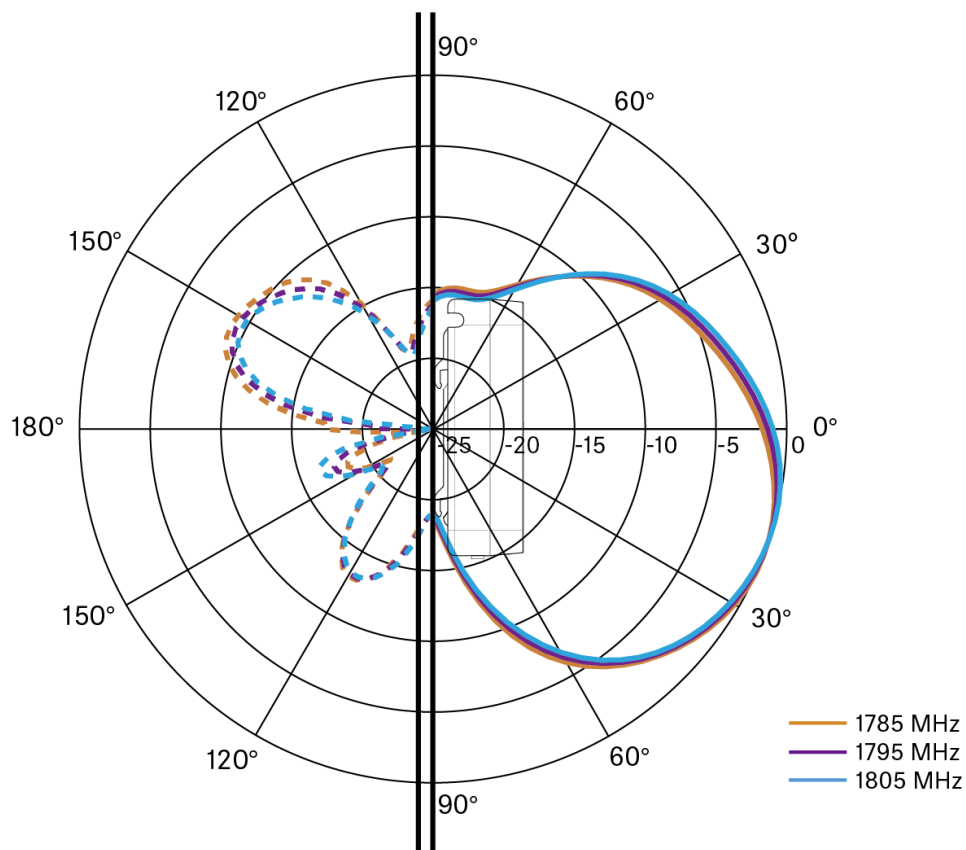



1G8 horizontal [dB]

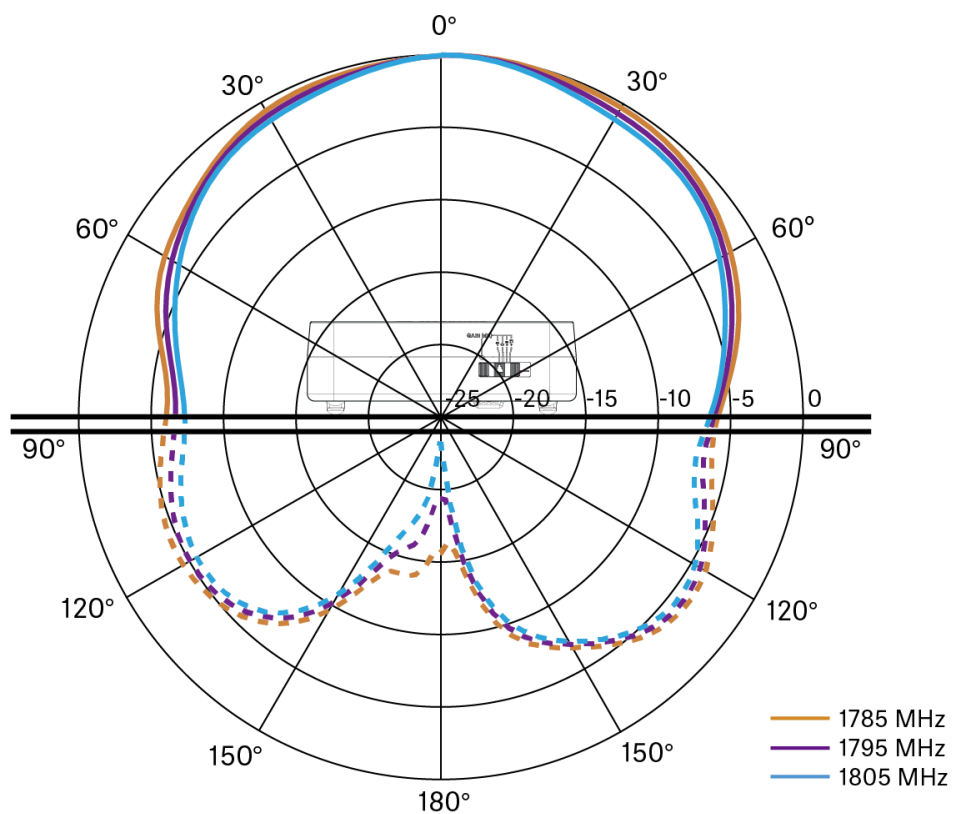



ADP UHF passive directional antenna (470 – 1075 MHz)

Frequency range

470 – 1075 MHz

Apex angle (-3 dB)

Approx. 100°

Front-to-back ratio

> 14 dB

Gain

Typically 5 dBi

Impedance

50 Ω

Connection

BNC female, no DC path

Thread for tripod mounting

3/8" and 5/8"

Dimensions

319 x 310 mm

Weight

Approx. 320 g

Operating temperature range

-10 °C to +55 °C

Storage temperature range

-20 °C – +85 °C (-4 °F – 158 °F)

Relative humidity

5 – 95 %



Typically Polar diagram

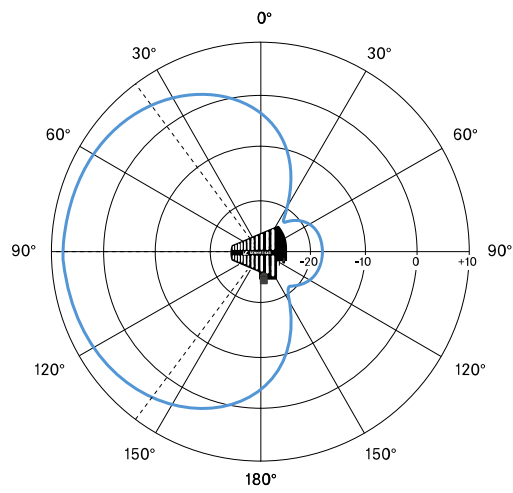



BA 70 rechargeable battery

Rated capacity

1720 mAh

Nominal voltage

3.8 V

Charging voltage

max. 4.35 V

Charging time

Typically 3 h @ room temperature

Dimensions

Approx. 54 x 30 x 15

Weight

Approx. 33 g

Temperature range

- Charging: 0 °C – +55 °C (32 °F – 131 °F)
- Discharging: -10 °C to +55 °C
- Storage: -10 °C to +45 °C

Relative humidity

- Charging/discharging: 25% to 95%, non-condensing
- Storage: 30% to 70%, non-condensing



L 70 USB charger

Charging capacity

2 Sennheiser BA 70 rechargeable battery packs

Input voltage

Typically 5 V

Input current

max. 2 A

Charging voltage

nominally 4.35 V

Charging current

max. 860 mA per battery pack

Charging time

max. 3.5 h with NT 5-20 UCW power supply unit

Temperature range

- Charging: 0 °C to +55 °C
- Storage: -20 °C to +70 °C

Relative humidity

Max. 95% (non-condensing)

Dimensions

100 × 35 × 70 mm (1 3/4" × 3 7/8" × 7 3/16")

Weight

Approx. 86 g



CHG 70N-C charger

Power supply

- DC 12 V (single unit or cascade of up to 5 units)
- PoE IEEE 802.3af Class 0 (CAT5e or higher), single unit only

Current consumption

max. 3.5 A for a cascade of up to 5 units

Ethernet

- RJ-45 socket, IEEE802.3
- 100Base-TX (half+full duplex)
- 10Base-T (half+full duplex)

Dimensions

Approx. 200 x 104 x 116 mm

Weight

Approx. 640 g, without power supply unit

Charging slots

2

Charging capacity per slot

- BA 70 rechargeable battery **or**
- EW-DX SK with BA 70 **or**
- EW-DX SKM with BA 70

Charging voltage

4.35 V

Charging current

min. 344 mA

max. 860 mA

Full charging time

Max. 3.5 h



Temperature range

- Charging: -10 °C to +50 °C
- Storage: -20 °C to +70 °C

Relative humidity

Max. 95% (non-condensing)



6. Contact

Contact information in case of questions about our products and/or services.



Questions about the product / Help with technical issues

If you have any questions about our products and/or services, please do not hesitate to contact us at <https://www.sennheiser.com/support>.

